

Tubing



Thermoplastic

Polyethylene

Nylon

Parprene™ TPE

Polypropylene

Polyurethane

Clear Vinyl

Fluoropolymer

PTFE

FEP

PFA

PVDF

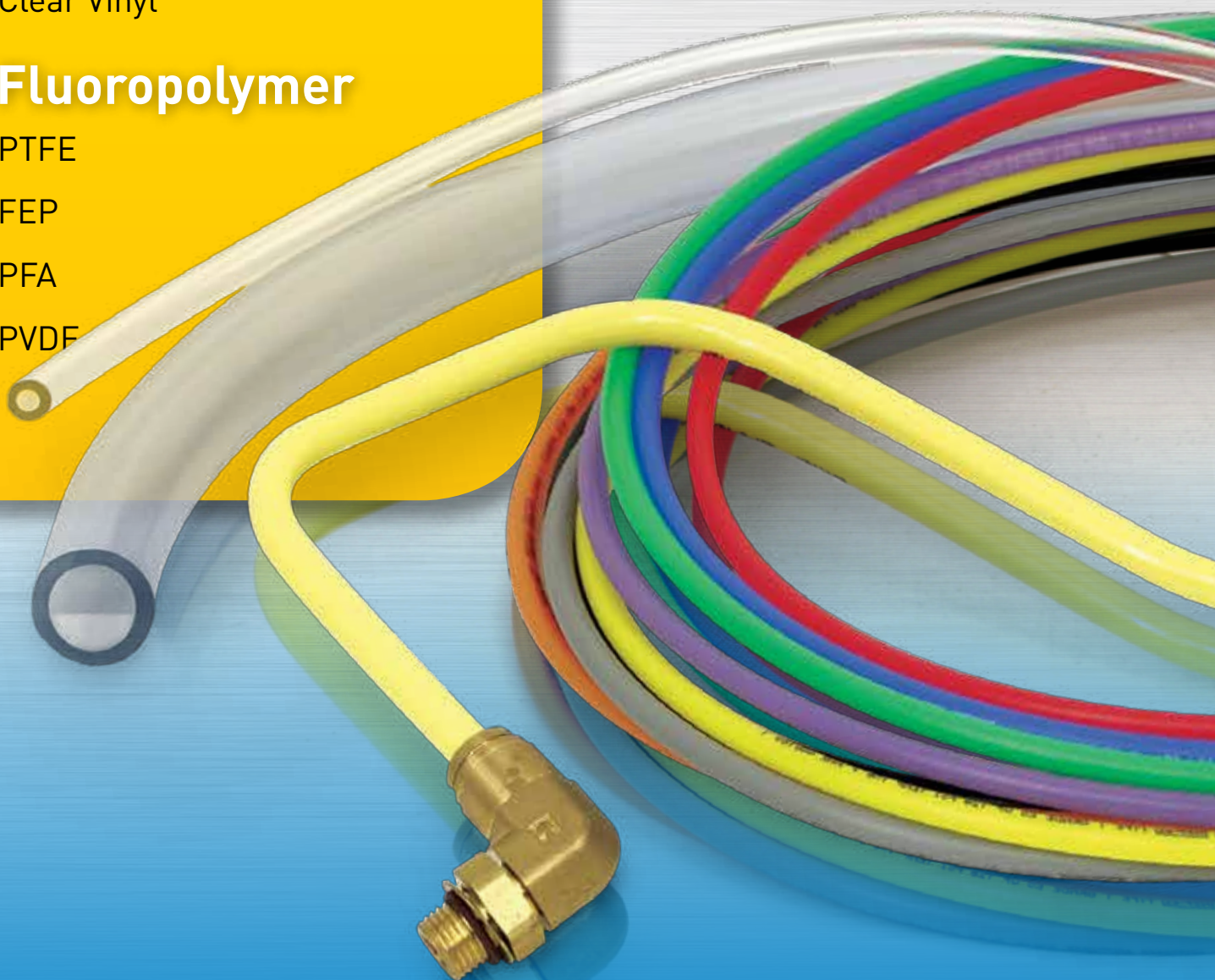

Table of Contents

Thermoplastic Tubing

Introduction

Intro	B-4 : B-9
Tubing Compatibility Chart Material Overview	B-6

Polyethylene Tubing

Fractional – Series E/EB	B-10
Metric – Series E/EB	B-12
Flame Resistant – Series PEFR	B-14
High Density – Series HDPE	B-16

Nylon Tubing

Fractional – Series N/NB	B-18
Metric – Series N/NB	B-20
Pure Air Tubing – Series PAT	B-22
Semi-rigid Tubing – Series NR	B-24
Series NTNA	B-26

Parprene™ Tubing

General Industrial – Series G:	B-28
Food & Dairy – Series F:	B-30

Polypropylene Tubing

Laboratory Grade – Series PP/PPB	B-32
--	------

Polyurethane Tubing

Fractional Polyether Base – Series U	B-34
Metric Polyether Base – Series UM	B-36
HUFR MicroWeld™ – Series HUFR	B-38
Fractional – Series HU	B-40
Metric – Series HUM	B-42

Clear Vinyl Tubing

Clear Vinyl Tubing – Series PV	B-44
--------------------------------------	------

Fluoropolymer Tubing

Introduction

Intro	B-48
Material Overview.....	B-50
Fluoropolymer Nomenclature.....	B-52

PTFE Tubing

Fractional – Series 101	B-54
Metric – Series 201.....	B-57
Fractional – Series TFS, TFT, TFL.....	B-58
AWG – Series TFH, TFS, TFT, TFL	B-60
Beading - Series TFB	B-65
Spiral Cut Cable Wrap, TSWTF.....	B-66
PTFE Fractional Heat Shrink - Series HS2TFS, HS2TFT, HS2TFL, HS2TFI	B-68
PTFE AWG 2:1 Heat Shrink - Series HS2TFS, HS2TFT, HS2TFL	B-70
PTFE AWG 4:1 Heat Shrink - Series HS4TFI	B-74
Convolute, Convo-Tex® - Series CV.....	B-76
Low Profile, Heavy Wall - Series CVL, CVH	B-79
SAE AS81914/1 and 2 - Series 81914	B-80

FEP Tubing

Fractional – Series 103.....	B-82
Metric – Series 203.....	B-83
FEP 1.3:1 Heat Shrink - Series HS1.3FEP	B-84
FEP 1.67:1 Heat Shrink - Series HS1.67FEP	B-86
FEP Roll Cover - Series HS1.25FEP	B-88
FEP/PTFE Double Shrink - Series TSSS, TSSL	B-89
Convolute- Series CV03, Convo-Flon™	B-90
SAE AS81914/3 and 4 - Series 81914	B-92
Corrugated - Series CR03.....	B-94
Retractable Coiled Tubing- Series 703.....	B-96

PFA Tubing

Fractional – Series 104.....	B-98
Metric – Series 204.....	B-99

High Purity PFA Tubing

Fractional – Series 105.....	B-100
Metric – Series 205.....	B-101

PVDF Tubing

Flex™– Series 110.....	B-102
Super-Flex™ – Series 111.....	B-103

Parflex Tubing Introduction

Parflex New, Tubing Product

Parflex has expanded the tubing line to include:



Parprene TPE, a thermoplastic elastomer formulated to withstand the rigors of peristaltic pump applications and yet, be safe enough for food and beverage applications. pgs. B-28 : B-31



Convoluted tubing for applications where flexibility is needed. Available in PTFE, FEP and PFA materials. pgs. B-76 : B-80, B-90 : B-92



FEP Roll Cover, a protective sleeve for rollers used with ink or in paper mills. pg. B-88



Corrugated tubing is the most flexible tubing available and is capable of turning sharp corners without reducing the inside diameter of the tube. Available in FEP and PFA. pg. B-94



Double Shrink Heat Shrink protects cables and other objects by totally encapsulating the parts as the FEP melts during the PTFE shrinking process. pg. B-89



Fluoroplastic coiled tubing is a spiral formed tube, consisting of a single or double retractable coil in a single tube. Available in FEP and PFA. pg. B-96

Parflex Tubing Tutorial

- Review the general attributes of Parflex thermoplastic and fluoropolymer tubing – this provides an excellent overview for the tubing product line.
- Review the application symbols - this will help you clear up any questions you may have on the product tables within the section. The market/applications table identifies and provides a “good fit” summary.
- Review the pressure bar graph - provides relative pressure ratings for the entire line of thermoplastic tubing. For fluoropolymer tubing, please contact Customer Service.
- Review the STAMPED guide (Size, Temperature, Media, Application, Pressure, End Configuration, and Delivery Preferences) on pg. 11 to help narrow your search for the desired product.
- Specific nomenclature, features, advantages and benefits can be found at the beginning page of each product line.
- Text appears in 2 colors. The primary dimensions are in black. As a courtesy, the metric/inch equivalent has been added and appears in blue.

Tubing Introduction

Tube Line Fabrication Guide for Leak Free Systems

Every hydraulic, pneumatic and lubrication system requires some form of tube line fabrication and fitting installation for completion. Proper fabrication and installation are essential for the overall efficiency, leak free performance and general appearance of any system.

Start by planning ahead. After sizing the tube lines and selecting the appropriate style of fitting, consider the following in the design of your system:

- Accessibility of joints
- Proper routing of lines
- Adequate tube line supports
- Available fabricating tools

Routing of Lines

Routing of lines is probably the most difficult, yet most significant, of these system design considerations. Proper routing involves getting a connecting line from one point to another through the most logical path.

Always try to leave fitting joints as accessible as possible. Hard to reach joints are hard to assemble and tighten properly. Inaccessible joints are also more difficult and time consuming to service.

Applications/Markets



Fluid Handling



Construction



Transportation



Industrial Pneumatic



Electrical



Military



General Industrial



Compressed Gas



Medical



Semiconductor



Food & Beverage



Pharmaceutical

For detailed ordering information, please consult price list or contact Parflex® Division.

Parflex Tubing Introduction

Tubing

Tubing Compatibility Chart

Parker Tubing / Hose Capability with Parker FSC Fittings

Product Sizes (inch)		Parflex Thermoplastic Tubing											
		Industrial Tubing Series (Outside Diameter Shown)								Industrial Tubing Series (O.D. shown)			
		Polyethylene E & EB Inch (4,5,6,8,10) Metric (6,8,10,12)	Polyethylene PE Inch (2,2.5,3,4,5,6,8)	Polyethylene PEFR Inch (2.5,4,6,8)	Polyethylene HDPE Inch (4,6)	Nylon N Inch (2,2.5,3,4,5,6,8) Metric (4mm - 20mm)	Nylon PAT Inch (2,4,6,8,10,12)	Nylon NR Inch (2,3,4,5,6,8)	Polypropylene PP & PPB Inch (2,3,4,5,6,8,10)	Polyurethane U (90 - 95 Shore A) Inch (2,3,4,6,8,9,12) Metric (4,6,8,10,12)	Polyurethane HU & HUM (>95 Shore A) Inch (2,2.5,4,6,8,12) Metric (4,6,8,10,12)	Polyurethane FR (Weld Tubing) Inch (4,5,6,8)	Clear Vinyl Inch (1/8" - 2 1/2")
C Coiled Air Hose & Fittings	Compression & Flare	Compression - Inch (2,3,4,5,6,7,8,10,12,14)	PS TS	PS TS	PS TS	PS TS	PS TS	PS TS	PS TS				
		Compress-Align - Inch (2,3,4,5,6,8,10,12,14,16)	TS	TS	TS	TS	TS	TS	TS				
		Metru-Lok - Metric (4,6,8,10,12,14,16,18,22)	TS	TS									
		Poly-Tite - Inch (2,3,4,5,6,8)					BS		BS				
		Hi-Duty - Inch (2,3,4,5,6,8,10)	TS	TS	TS	TS	TS	TS	TS				
		45 degree flare - Inch (2,3,4,5,6,8,10,12,14)											
		Inverted Flare - Inch (2,3,4,5,6,8,10,12,14)											
		Fast & Tite - Inch (4,5,6,8,10)								TS	TS		TS
D Transportation	Push-to-Connect	Flow Controls - Inch (2,2.5,4,5,6,8) Metric (4,6,8,10,12)											
		Prestolok Brass - Inch (2,2.5,3,4,5,6,8) Metric (4,5,6,8,10,12,14)											
		Prestolok Composite Inch (2,2.5,3,4,5,6,8) Metric (4,5,6,8,10,12,14)											
		Liquifit - Inch (4,6,8)											
		TrueSeal - Inch (4,5,6,8)								TS	TS		TS
E Fittings	Barb	Par-Barb - Inch (2,3,4,5,6,8,10,12)							CL			CL	
		Dubl-Barb - Inch (2.5,4,6,8)											
		Hose Barb - Inch (2,3,4,5,6,8,10,12,16) Inside Diameter											CL
		Garden Hose											CL
F Tooling, Equipment & Accessories	DOT Transportation	NTA - Inch (3,4,6,8,10,12)											
		Transmission Fittings - Inch (2,2.5)											
		Air Brake - Inch (4,6,8,10,12,16)											
		Air Brake Hose - Inch (6,8)											
		Vibra-Lok - Inch (2,3,4,5,6,8,10,12)											
		Prestomatic - Inch (2,2.5,3,4,6,8,10,12) Metric (6,8,10,12,16)											
		PTC - Inch (4,6,8,10,12)											
		SAE Cartridges - Inch (2,5,4,6,8,10,12)											
		Manifolds - Inch (4,6,8)											

PS = Plastic sleeve & tube support recommended
 TS = Tube support is recommended
 BS = Brass sleeve recommended
 CL = Clamp required

General Technical



For detailed ordering information, please consult price list or contact Parflex® Division.

Parflex Thermoplastic Tubing				Parflex Fluoropolymer Tubing				Product Sizes (inch)	
Transportation Tubing				PFA Fluoropolymer Inch (3/32" - 1") Metric (4mm - 12mm)	FEP Fluoropolymer Inch (1/8" - 1") Metric (3mm - 12mm)	PTFE Fluoropolymer Inch (3/32" - 1") Metric (3mm - 16mm)	PVDF Fluoropolymer Inch (2,3,4,5,6,8,10,12,16)		
PFT Air Brake (SAE J844) Inch (2,2.5,3,4,5,6,8,10,12)	Air Brake DIN 74324 (Nylon 12) Metric (4,6,8,10,12,15,16,18)	PFT Diesel Fuel Sizes 4,6,8,10,12	HTFL Diesel Fuel Sizes 4,6,8,10,12						
				PS	PS	PS		Compression - Inch (2,3,4,5,6,7,8,10,12,14)	Compression & Flare
				TS	TS	TS		Compress-Align - Inch (2,3,4,5,6,8,10,12,14,16)	
								Metru-Lok - Metric (4,6,8,10,12,14,16,18,22)	
								Poly-Tite - Inch (2,3,4,5,6,8)	
								Hi-Duty - Inch (2,3,4,5,6,8,10)	
								45 degree flare - Inch (2,3,4,5,6,8,10,12,14)	
								Inverted Flare - Inch (2,3,4,5,6,8,10,12,14)	
								Fast & Tite - Inch (4,5,6,8,10)	Push-to-Connect
								Flow Controls - Inch (2,2.5,4,5,6,8) Metric (4,6,8,10,12)	
								Prestolok Brass - Inch (2,2.5,3,4,5,6,8) Metric (4,5,6,8,10,12,14)	
								Prestolok Composite Inch (2,2.5,3,4,5,6,8) Metric (4,5,6,8,10,12,14)	
								Liquifit - Inch (4,6,8)	Barb
								TrueSeal - Inch (4,5,6,8)	
								Par-Barb - Inch (2,3,4,5,6,8,10,12)	
								Dubl-Barb - Inch (2.5,4,6,8)	DOT Transportation
								Hose Barb - Inch (2,3,4,5,6,8,10,12,16) Inside Diameter	
								Garden Hose	
								NTA - Inch (3,4,6,8,10,12)	
								Transmission Fittings - Inch (2,2.5)	
								Air Brake - Inch (4,6,8,10,12,16)	
								Air Brake Hose - Inch (6,8)	
								Vibra-Lok - Inch (2,3,4,5,6,8,10,12)	
								Prestomatic - Inch (2,2.5,3,4,6,8,10,12) Metric (6,8,10,12,16)	
								PTC - Inch (4,6,8,10,12)	
								SAE Cartridges - Inch (2.5,4,6,8,10,12)	
								Manifolds - Inch (4,6,8)	

Tube Line Fabrication Guide for Leak Free Systems

Every hydraulic, pneumatic and lubrication system requires some form of tube line fabrication and fitting installation for completion. Proper fabrication and installation are essential for the overall efficiency, leak free performance, and general appearance of any system.

Start by planning ahead. After sizing the tube lines and selecting the appropriate style of fitting, consider the following in the design of your system:

1. Accessibility of joints
2. Proper routing of lines
3. Adequate tube line supports
4. Available fabricating tools

PS = Plastic sleeve & tube support recommended
 TS = Tube support is recommended
 BS = Brass sleeve recommended
 CL = Clamp required

For detailed ordering information, please consult price list or contact Parflex® Division.



B Tubing

C Coiled Air Hose & Fittings

D Transportation

E Fittings

F Tooling, Equipment & Accessories

G General Technical

Thermoplastic Tubing

Tubing
Thermoplastic
B

Polyethylene

- Parflex polyethylene tubing meets FDA, NSF Standard 51 for all food contact applications and NSF-61 for potable water applications.
- E-Series tubing is made of 100% virgin resin material.
- Polyethylene tubing meets ASTM D-1693 (10% IGEPAL) for stress crack resistance.
- Parflex also offers special PE tubing: PEFR (flame retardant) and HDPE (high density).

Nylon

- Flexible nylon tubing is constructed of high-grade resins for strength and flexibility for routing in tight spaces.
- Semi-rigid high strength nylon is constructed of high-grade resins without the addition of plasticizers for higher pressure tubing applications.
- Pure Air Tubing (PAT) is the tubing choice for pure air systems (semiconductor) due to its cleanliness; in addition, it offers excellent chemical and UV light resistance.
- NTNA Tubing meets NSF Standard 51 for all food contact applications and may be used for instrumentation lines, lubrication and process piping systems and oil and refrigerant lines.

Coiled Air Hose
& Fittings
C

Parprene™ (thermoplastic elastomer)

- Excellent flexural fatigue resistance.
- Resistant to environmental stress cracking.
- Series F meets FDA, NSF Standard 51 and 3-A approved for all food contact applications.

Transportation
D

Polypropylene

- Polypropylene tubing meets FDA, NSF Standard 51 for all food contact applications.
- Polypropylene tubing exhibits excellent chemical resistance to chlorinated water applications.
- Black Polypropylene tubing is commonly used in outdoor applications where UV light stabilization is required.

Fittings
E

Polyurethane

- Polyurethane tubing is a flexible, kink-resistant and abrasion-resistant material commonly used in pneumatic applications.
- Polyurethane is available in multiple transparent and opaque colors for system color coding.
- Polyurethane is available in the following durometers (measurement of material hardness):
 - Medium durometer: (90 - 95)
 - High durometer: (>95) for higher pressures

Tooling, Equipment
& Accessories
F

Polyvinyl Chloride (PVC)

- PVC tubing is made from 100% virgin resin material and meets all FDA specifications for materials in contact with food and drugs.
- PVC tubing is a very flexible, 70 durometer tubing. It is crystal-clear and ideal for situations where visible fluid flow is necessary (i.e. sight gauges for tank identification).

**All plastic tubing dimensions are laser monitored to ensure overall quality product.
Most tubing sizes are packaged in convenient 100-ft., 250-ft., 500-ft. and 1,000-ft. lengths.**

General Technical
G

Thermoplastic Tubing

Typical Applications

Product Family	Series	Suggested Markets and Applications
Polyethylene	E and EB	Potable water, chemical transfer, and low-cost, low-pressure pneumatics, NSF-51 & NSF- 61
	PEFR	Pneumatic controls in HVAC
	HDPE	Chemical transfer and low-cost pneumatics
Nylon	N	Pneumatic and petroleum-based chemical transfer
	PAT	Pure air and gas distribution systems, semiconductor
	NR	High pressure pneumatic, low pressure lubrication and hydraulic, marine control systems
	NTNA	Instrumentation lines, lubrication and process piping systems, oil and refrigerant lines, NSF-51
Polypropylene	PP and PPB	Food contact and chemical transfer applications, chlorinated water, NSF-51
Urethane	U and UM	Pneumatic controls requiring high flexibility, kink resistance and movement
	HU and HUM	High-pressure pneumatics requiring flexibility and kink resistance, robotics
Parprene™	TPE, Series G	Thermoplastic elastomer, black, general industrial tubing
	TPE, Series F	Thermoplastic elastomer, tan, food & dairy FDA compliant tubing
Vinyl	PV	Low-pressure chemical and medical applications requiring high clarity and flexibility, FDA

Tubing Pressure Ranges

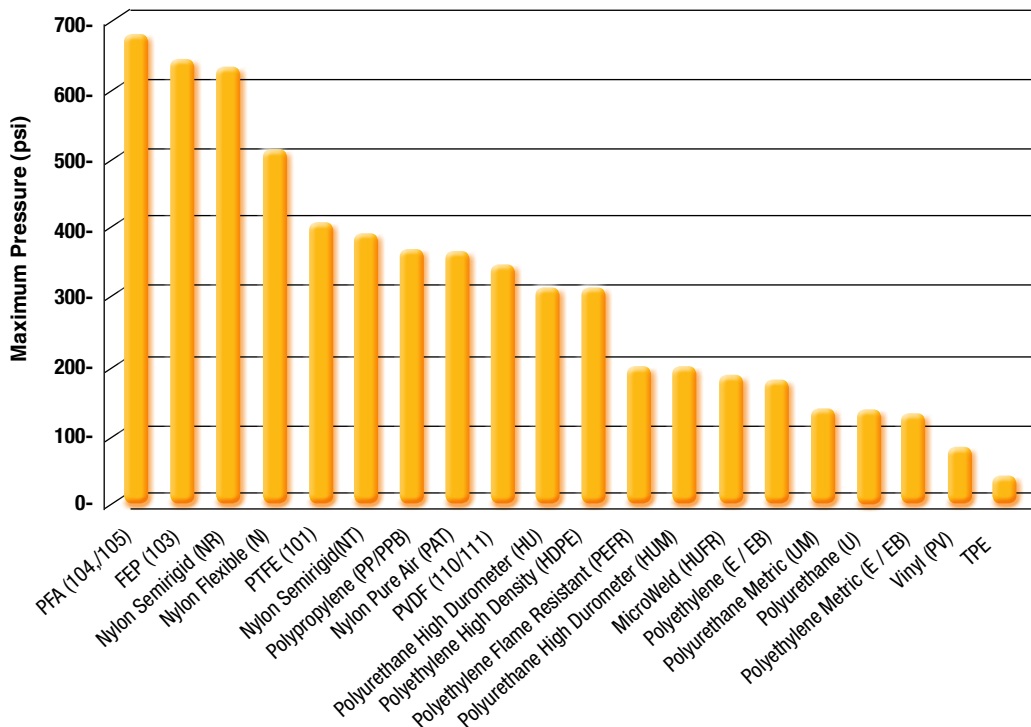

Working pressures are at 73°F (23°C). Pressure ratings are also effected by diameter of tubing and wall thickness. Actual performance may vary with different media and working conditions. Use this information for comparison only.

For detailed ordering information, please consult price list or contact Parflex® Division.



Polyethylene Tubing

Series E: Instrument Grade – FDA, NSF Listed
Series EB: Ultraviolet Light Resistant



Features

- Made from 100% virgin resin material
- Chemically resistant and flexible
- High molecular weight resin provides increased dimensional stability, uniformity and long-term strength
- Economical system solution

Certifications

- FDA compliant for food contact
- ASTM D-1693 (10% IGEPAL) for stress crack resistance
- NSF - 51
- NSF - 61

Applications/Markets



- Potable water
- Chemical transfer
- Low-pressure pneumatics



Part Number	Part Number	Tube O.D.		Tube I.D.		Average Wall Thickness		Working Pressure at 73°F / 23°C		Minimum Burst at 73°F / 23°C		Package Quantity	Minimum Bend Radius		Weight	
		inch	mm	inch	mm	inch	mm	psi	bar	psi	bar		feet	inch	mm	lbs./ft.
#	#						Package quantities vary by size and color									
Natural	Black	inch	mm	inch	mm	inch	mm	psi	bar	psi	bar	feet	inch	mm	lbs./ft.	kg./mtr.
E-43-XXXX	EB-43-XXXX	1/4	6.4	.170	4.3	.040	1.0	120	8.3	480	33.1	0100, 0500, 1000	1.00	25.4	.011	.016
E-53-XXXX	EB-53-XXXX	5/16	7.9	.187	4.8	.062	1.6	145	10.0	580	40.0	0100, 0500	1.13	28.7	.020	.030
E-64-XXXX	EB-64-XXXX	3/8	9.5	.250	6.4	.062	1.6	125	8.6	500	34.5	0100, 0500	1.25	31.8	.025	.037
E-86-XXXX	EB-86-XXXX	1/2	12.7	.375	9.5	.062	1.6	90	6.2	360	24.8	0100, 0500	2.50	63.5	.034	.051
E-108-XXXX	EB-108-XXXX	5/8	15.9	.500	12.7	.062	1.6	70	4.8	280	19.3	0100	4.00	101.6	.044	.065

Standard black is not NSF approved.



For detailed ordering information, please consult price list or contact Parflex® Division.

Parker Hannifin Corporation | Parflex® Division | Ravenna, Ohio | parker.com/pfd

Order Information

Example: E-64-Y-0500

E-64-Y-0500 – Polyethylene

E-64-Y-0500 – **Tube O.D.** in sixteenths of an inch (**3/8"**)

E-64-Y-0500 – **Tube I.D.** in sixteenths of an inch (**.250"**)

E-64-Y-0500 – **Color**, i.e. **Yellow** (Omit for Natural and Black)

E-64-0500 – Natural Polyethylene

EB-64-0500 – Black Polyethylene

E-64-Y-0500 – **Package Quantity** in feet (**500'**)

Available in black as well as nine other colors, as recommended by the Instrument Society of America

Color Code		
●	-	Natural
●	-	Black
●	B	Blue
●	G	Green
●	O	Orange
●	P	Purple
●	R	Red
●	GRA	Gray
●	Y	Yellow
○	WHT	White

Polyethylene Tubing (Series E)

Maximum Working Pressure (psig)

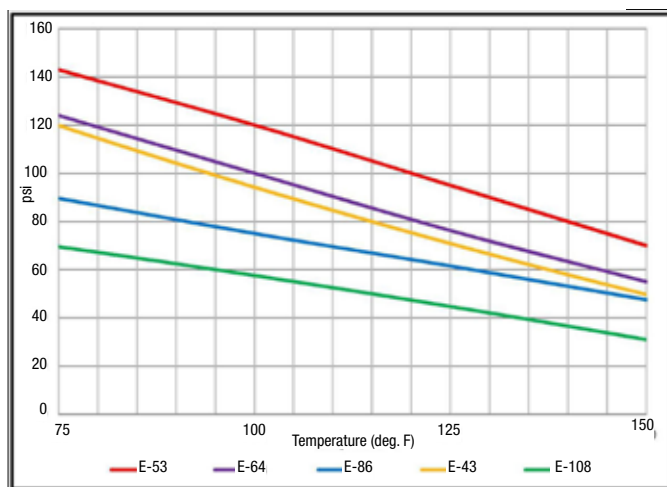

Fittings

Parker fittings available from:
Fluid System Connectors Division
Otsego, MI
(269) 692-6555
(269) 694-4614 FAX

FSC Product Families:

- Compression
- Compress-Align®
- Poly-Tite
- Hi-Duty
- Fast & Tite
- Flow Control
- Prestolok Brass
- Prestolok Composite
- Liquifit
- TrueSeal™
- Dubl-Barb®
- Prestomatic
- SAE Cartridge

A tube support should be used with this tubing for maximum holding power where end loading, vibration or pressure spikes may occur. Reference Tubing/Fitting Compatibility Chart (pg. B-6)

Notes

- FDA, NSF-51 and NSF-61 compliant black polyethylene tubing is also available. Add -NSF suffix to the EB part number (ie. EB-64-0500-NSF)
- E series natural and colored tubing meet FDA, NSF-51 requirements for food contact applications and NSF-61 for potable water
- Resistant to environmental stress cracking exceeding that of ordinary polyethylene tubing as measured by ASTM D-1693 (10% IGEPAL)
- Black (EB) tubing contains an ultraviolet inhibitor which is recommended for use in sunlit areas and in close proximity to high ultraviolet light sources
- All tubing conforms to ASTM D-1248, Type I, Class A, Category 4, Grade E5
- The recommended operating temperature range for service at rated pressures with compatible fluids is -80°F to +150°F (-62°C to +66°C)

Colors

- See Color Code Table

For detailed ordering information, please consult price list or contact Parflex® Division.

Metric Polyethylene Tubing

Series E: Instrument Grade – FDA, NSF Listed
Series EB: Ultraviolet Light Resistant



Features

- Made from 100% virgin resin material
- Chemically resistant and flexible
- High molecular weight resin provides increased dimensional stability, uniformity and long-term strength
- Economical system solution

Certifications

- FDA compliant for food contact
- ASTM D-1693 (10% IGEPAL) for stress crack resistance
- NSF - 51
- NSF - 61

Applications/Markets



- Potable water
- Chemical transfer
- Low-pressure pneumatics



Part Number	Part Number	Tube O.D.		Tube I.D.		Average Wall Thickness		Working Pressure at 73°F / 23°C		Minimum Burst at 73°F / 23°C		Package Quantity	Minimum Bend Radius		Weight		
		mm	inch	mm	inch	mm	inch	bar	psi	bar	psi		feet	mm	inch	kg./mtr.	lbs./ft.
#	#																
Natural	Black	mm	inch	mm	inch	mm	inch	bar	psi	bar	psi	feet	mm	inch	kg./mtr.	lbs./ft.	
E-6X1-0100	EB-6X1-0100	6	.236	4	.157	1.00	.039	8.6	125	34.5	500	0100	25	1.00	.019	.013	
E-8X1-0100	EB-8X1-0100	8	.315	6	.236	1.00	.039	6.9	100	27.6	400	0100	38	1.50	.021	.014	
E-10X1.5-0100	EB-10X1.5-0100	10	.393	7	.276	1.50	.059	8.6	125	34.5	500	0100	38	1.50	.039	.026	
E-12X1.5-0100	EB-12X1.5-0100	12	.472	9	.354	1.50	.059	6.2	100	24.8	400	0100	63	2.50	.048	.032	

Standard black is not NSF approved.



For detailed ordering information, please consult price list or contact Parflex® Division.

Parker Hannifin Corporation | Parflex® Division | Ravenna, Ohio | parker.com/pfd

Order Information

Example: E-8x1-0100

E-8x1-0100 – Metric Polyethylene (Natural)

EB-8x1-0100 – Metric Polyethylene (Black)

E-8x1-0100 – Tube O.D. in millimeters (8 mm)

E-8x1-0100 – Tube Wall Thickness in millimeters (1 mm)

E-8x1-0100 – Package Quantity in feet (100')

Metric Polyethylene Tubing (Series E)

Maximum Working Pressure (bar)

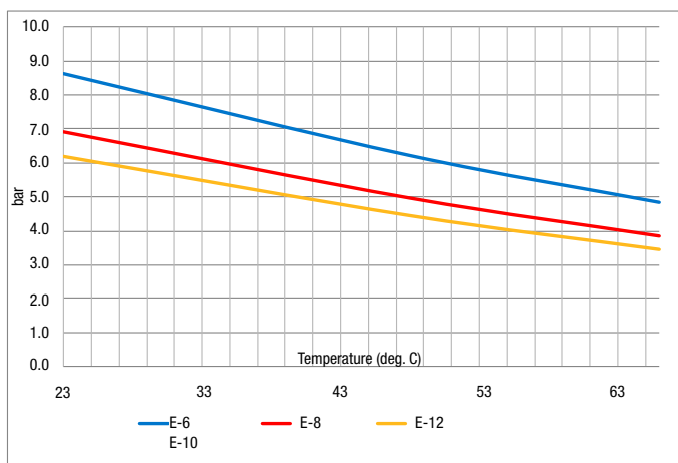

Fitting Recommendations

Parker fittings available from:
Fluid System Connectors Division
Otsego, MI
(269) 692-6555
(269) 694-4614 FAX

FSC Product Families:

- Metru-Lok™
- Flow Control
- Prestolok Brass
- Prestolok Composite
- Prestomatic

A tube support should be used with this tubing for maximum holding power where end loading, vibration or pressure spikes may occur. Reference Tubing/Fitting Compatibility Chart (pg. B-6)

Notes

- E series natural and colored tubing listed below meet FDA, NSF-51 requirements for food contact applications and NSF-61 for potable water
- Resistant to environmental stress cracking exceeding that of ordinary polyethylene tubing as measured by ASTM D-1693 (10% IGEPAL)
- Black (EB) tubing contains an ultraviolet inhibitor which is recommended for use in sunlit areas and in close proximity to high ultraviolet light sources
- All tubing conforms to ASTM D-1248, Type I, Class A, Category 4, Grade E5
- The recommended operating temperature range for service at rated pressures with compatible fluids is -80°F to +150°F (-62°C to +66°C)

Colors

- Natural
- Black

For detailed ordering information, please consult price list or contact Parflex® Division.

Polyethylene Tubing

Series PEFR: Flame Resistant

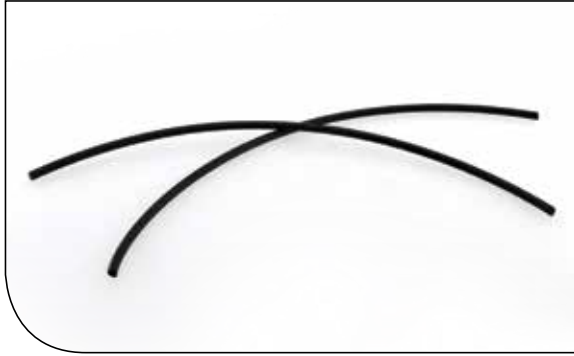

Features

- Excellent stress crack resistance

Certifications

- UL 94 V-2
- ASTM D-1693 (10% IGEPAL) for stress crack resistance

Applications/Markets



- Pneumatic controls in HVAC applications

Part Number	Tube O.D.		Tube I.D.		Average Wall Thickness		Working Pressure at 73°F / 23°C		Minimum Burst at 73°F / 23°C		Package Quantity	Minimum Bend Radius		Weight	
	inch	mm	inch	mm	inch	mm	psi	bar	psi	bar		feet	inch	mm	lbs./ft.
#															
Black															
PEFR-2.5-XXXX	5/32	4.0	.096	2.4	.030	0.76	185	12.8	740	51.0	0500	.50	12.7	.006	.009
PEFR-4-XXXX	1/4	6.4	.170	4.3	.040	1.0	140	9.7	560	38.6	0500, 1000	.75	17.4	.012	.018
PEFR-6-XXXX	3/8	9.5	.250	6.4	.062	1.6	155	10.7	620	42.8	0500	1.50	36.1	.029	.043
PEFR-8-XXXX	1/2	12.7	.375	9.5	.062	1.6	100	6.9	400	27.6	0250	1.75	39.1	.041	.061

Order Information

Example: PEFR-4-0500

PEFR-4-0500 – Flame Resistant Polyethylene

PEFR-**4**-0500 – **Tube O.D.** in sixteenths of an inch (**1/4"**)

PEFR-4-**0500** – **Package Quantity** in feet (**500'**)

Flame Resistant Polyethylene Tubing (Series PEFR) Maximum Working Pressure (psig)

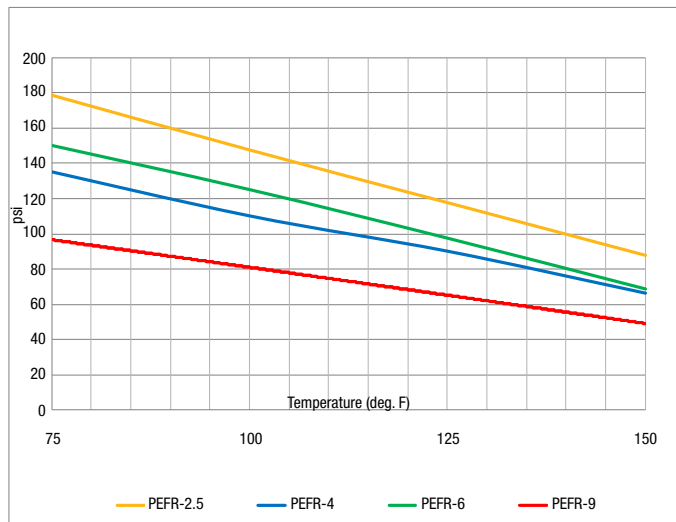

Fittings

Parker fittings available from:
Fluid System Connectors Division
Otsego, MI
(269) 692-6555
(269) 694-4614 FAX

- FSC Product Families:
- Compression
- Compress-Align®
- Hi-Duty
- Fast & Tite
- Flow Control
- Prestolok Brass
- Dubl-Barb®

A tube support should be used with this tubing for maximum holding power where end loading, vibration or pressure spikes may occur. Reference Tubing/Fitting Compatibility Chart (pg. B-6)

Notes

Using the same base linear low-density polyethylene (LLDPE) as the E-Series tubing, Parker Hannifin, Parflex Division's PEFR tubing has the following advantages:

- Resistant to environmental stress cracking exceeding that of ordinary polyethylene tubing as measured by ASTM D-1693 (10% IGEPAL)
- The recommended operating temperature range for service at rated pressures with compatible fluids is -85°F to +150°F (-65°C to +66°C)

Colors

- Black

For detailed ordering information, please consult price list or contact Parflex® Division.

Polyethylene Tubing

Series HDPE: High Density

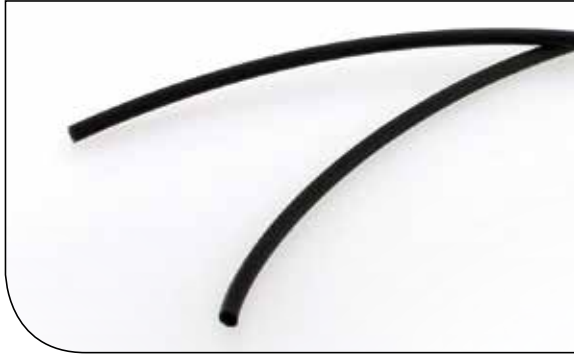

Features

- Manufactured from high strength, high density polyethylene
- Semi-rigid tubing that is inherently resistant to most chemicals, less easily cut or damaged and has a higher burst pressure rating than Series E tubing
- Economical system solution

Applications/Markets



- Potable water
- Chemical transfer
- Low-pressure pneumatics



Part Number	Tube O.D.		Tube I.D.		Average Wall Thickness		Working Pressure at 73°F /23°C		Minimum Burst at 73°F /23°C		Package Quantity	Minimum Bend Radius		Weight	
	inch	mm	inch	mm	inch	mm	psi	bar	psi	bar		feet	inch	mm	lbs./ft.
#															
Black	inch	mm	inch	mm	inch	mm	psi	bar	psi	bar	feet	inch	mm	lbs./ft.	kg./mtr.
HDPE-43-XXXX	1/4	6.4	.170	4.3	.040	1.0	300	20.7	1200	82.7	0250, 0500	1.50	38.1	.011	.016
HDPE-64-XXXX	3/8	8.5	.250	6.4	.062	1.6	300	20.7	1200	82.7	0250, 0500	2.50	63.5	.025	.037

Only available in black.



Order Information

Example: HDPE-43-0500

HDPE-43-0500 – High Density Polyethylene

HDPE-**43**-0500 – **Tube O.D.** in sixteenths of an inch (**1/4"**)

HDPE-**43**-0500 – **Tube I.D.** in sixteenths of an inch (**.170"**)

HDPE-43-**0500** – **Package Quantity** in feet (**500'**)

High Density Polyethylene Tubing (Series HDPE)

Maximum Working Pressure (psig)

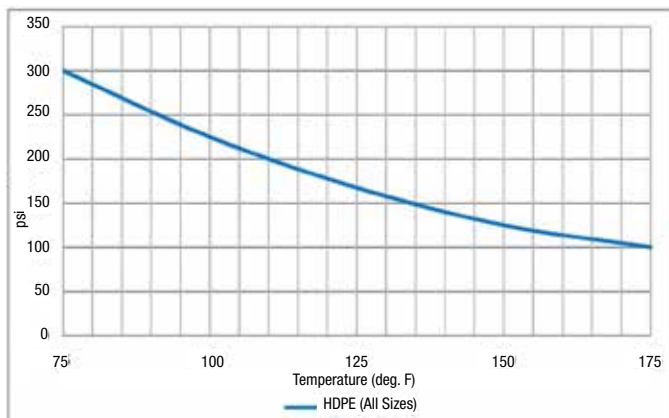

Fittings

Parker fittings available from:
Fluid System Connectors Division
Otsego, MI
(269) 692-6555
(269) 694-4614 FAX

- FSC Product Families:
- Compression
- Compress-Align®
- Dubl-Barb
- Hi-Duty
- Fast & Tite
- Prestolok Brass

A tube support should be used with this tubing for maximum holding power where end loading, vibration or pressure spikes may occur. Reference Tubing/Fitting Compatibility Chart (pg. B-6)

Notes

- Recommended operating temperature range for service at rated pressures with compatible fluids is -80°F to +175°F (-62°C to +80°C)

Colors

- Black

For detailed ordering information, please consult price list or contact Parflex® Division.

Nylon Tubing

Series N: Flexible

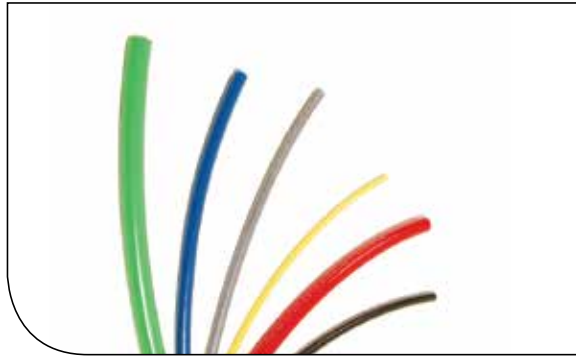

Features

- Flexible nylon tubing uses high-grade resins for strength and flexibility for routing in tight spaces
- Made from abrasion-resistant, heat and light-stabilized nylon
- Exhibits low-level water absorption
- Chemically resistant

Applications/Markets



- Robotics
- Machine tool
- General pneumatics
- Lubrication

- Petroleum-based chemical transfer
- Pest control lines



Part Number	Part Number	Tube O.D.		Tube I.D.		Average Wall Thickness		Working Pressure at 73°F / 23°C		Minimum Burst at 73°F / 23°C		Reel Length	Minimum Bend Radius		Weight	
		inch	mm	inch	mm	inch	mm	psi	bar	psi	bar		feet	inch	mm	lbs./ft.
#	#															
Natural	Black															
NN-2-016	NB-2-016	1/8	3.2	.093	2.4	.016	0.41	250	17.2	1000	69.0	0100, 0250	.25	4.6	.003	.005
NN-2-031	NB-2-031	1/8	3.2	.064	1.6	.031	0.79	500	34.5	2000	137.9	0100, 0250	.25	4.6	.004	.006
NN-2.5-025	NB-2.5-025	5/32	4.0	.106	2.7	.025	0.64	300	20.7	1200	82.7	0100, 0250	.50	12.7	.005	.007
NN-3-025	NB-3-025	3/16	4.8	.138	3.5	.025	0.64	250	17.2	1000	69.0	0100, 0250	.63	16.0	.006	.009
NN-3-046	NB-3-046	3/16	4.8	.096	2.4	.046	1.2	500	34.5	2000	137.9	0100, 0250	.44	11.2	.009	.013
NN-4-035	NB-4-035	1/4	6.4	.180	4.6	.035	0.89	250	17.2	1000	69.0	0100, 0250	.88	22.4	.011	.016
NN-4-040	NB-4-040	1/4	6.4	.170	4.3	.040	1.0	310	21.4	1250	86.2	0100, 0250	.88	22.4	.012	.018
NN-4-062	NB-4-062	1/4	6.4	.127	3.2	.062	1.6	500	34.5	2000	137.9	0100, 0250	.50	12.7	.017	.025
NN-5-040	NB-5-040	5/16	7.9	.233	5.9	.040	1.0	250	17.2	1000	69.0	0100, 0250	1.13	28.7	.016	.024
NN-6-050	NB-6-050	3/8	9.5	.275	7.0	.050	1.3	250	17.2	1000	69.0	0100, 0250	1.13	28.7	.023	.034
NN-6-093	NB-6-093	3/8	9.5	.190	4.8	.093	2.4	500	34.5	2000	137.9	0100, 0250	.75	19.0	.038	.056
NN-8-062	NB-8-062	1/2	12.7	.375	9.5	.062	1.6	250	17.2	1000	69.0	0100, 0250	1.25	31.8	.039	.058
NN-8-124	NB-8-124	1/2	12.7	.253	6.4	.124	3.2	500	34.5	2000	137.9	0100, 0250	1.00	25.4	.067	.099

Order Information

Example: N-2-016-RED-0100

N-2-016-RED-0100 – Nylon

N-2-016-RED-0100 – **Tube O.D.** in sixteenths of an inch (**1/8"**)

N-2-016-RED-0100 – **Wall Thickness** in inches (**.016"**)

N-2-016-RED-0100 – **Colors** (Omit for Natural and Black)

NN-2-016-0100 - Natural Nylon

NB-2-016-0100 - Black Nylon

N-2-016-RED-0100 – **Package Quantity** in feet (**100'**)

(Omit quantity number after color for 250' reel length)

Color Code		
○	NN	Natural
●	NB	Black
●	BLU	Blue
●	GRN	Green
●	RED	Red
●	YEL	Yellow

Nylon Tubing (Series N)

Maximum Working Pressure (psig)

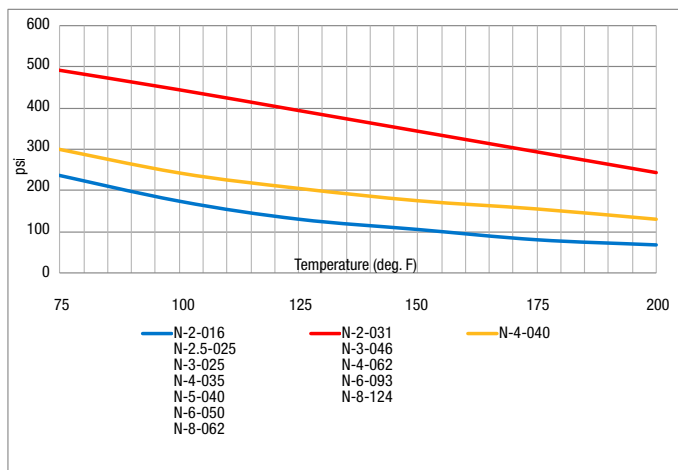

Fittings

Parker fittings available from:
Fluid System Connectors Division
Otsego, MI
(269) 692-6555
(269) 694-4614 FAX

FSC Product Families:

- Compression
- Compress-Align®
- Poly-Tite
- Hi-Duty
- Fast & Tite
- Flow Control
- Prestolok Brass
- Prestolok Composite
- TrueSeal™
- NTA®
- Transmission
- Prestomatic
- SAE Cartridge

A tube support should be used with this tubing for maximum holding power where end loading, vibration or pressure spikes may occur. Reference Tubing/Fitting Compatibility Chart (pg. B-6)

Notes

- The recommended operating temperature range for service at rated pressures with compatible fluids, depending upon conditions, is -65°F to +200°F (-54°C to +93°C)
- Black tubing suggested for use in sunlit areas and in close proximity to high ultraviolet light sources

Colors

- See Color Code Table

Metric Nylon Tubing

Series N: Flexible



Features

- Flexible nylon tubing uses high-grade resins for strength and flexibility for routing in tight spaces
- Made from abrasion-resistant, heat and light-stabilized nylon
- Exhibits low-level water absorption
- Chemically resistant

Applications/Markets



- Robotics
- Machine tool
- General pneumatics
- Lubrication

- Petroleum-based chemical transfer
- Pest control lines



Part Number	Part Number	Tube O.D.		Tube I.D.		Average Wall Thickness		Working Pressure at 73°F / 23°C		Minimum Burst at 73°F / 23°C		Reel Length	Minimum Bend Radius		Weight	
		mm	inch	mm	inch	mm	inch	bar	psi	bar	psi		feet	mm	inch	kg./mtr.
#	#															
Natural	Black	mm	inch	mm	inch	mm	inch	bar	psi	bar	psi	feet	mm	inch	kg./mtr.	lbs./ft.
NN4X.65	NB4X.65	4	.157	2.7	.107	0.65	.026	20.7	300	82.7	1200	100	14	.550	.007	.005
NN6X1	NB6X1	6	.236	4.0	.157	1.00	.039	23.5	341	94	1363	100	22	.866	.016	.011
NN8X1	NB8X1	8	.315	6.0	.236	1.00	.039	17.0	247	68	986	100	29	1.14	.024	.016
NN10X1	NB10X1	10	.393	8.0	.315	1.00	.039	12.5	181	50	725	100	34	1.34	.030	.020
NN12X1	NB12X1	12	.472	10.0	.393	1.00	.039	11.0	160	44	638	100	45	1.77	.036	.024
NN14X1.5	NB14X1.5	14	.551	11.0	.433	1.50	.059	15.0	218	60	870	100	57	2.24	.063	.042
NN16X1.5	NB16X1.5	16	.630	13.0	.512	1.50	.059	12.5	181	50	725	100	74	2.91	.073	.049
NN18X1.5	NB18X1.5	18	.709	15.0	.591	1.50	.059	10.5	152	42	609	100	92	3.62	.082	.055
NN20X1.5	NB20X1.5	20	.787	17.0	.669	1.50	.059	9.5	138	38	551	100	112	4.41	.092	.062

Order Information

Example: NN4x.65

NN4x.65 – Natural Nylon

NN4x.65 – Tube O.D. in millimeters (4mm)

NN4x.65 – Wall Thickness in millimeters (0.65mm)

Metric Nylon Tubing (Series N)

Maximum Working Pressure (bar)

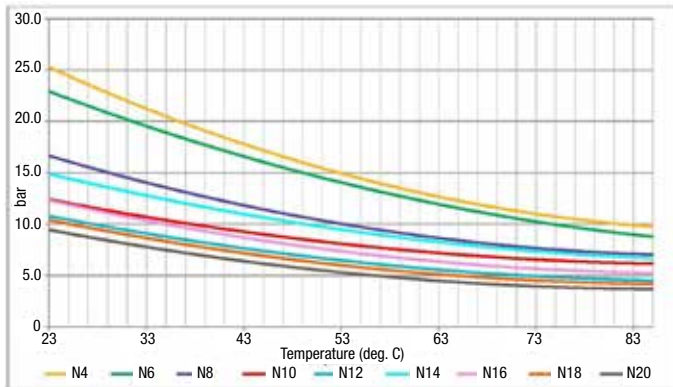

Fittings

Parker fittings available from:
Fluid System Connectors Division
Otsego, MI
(269) 692-6555
(269) 694-4614 FAX

FSC Product Families:

- Metru-Lok™
- Flow Control
- Prestolok Brass
- Prestolok Composite
- Prestomatic

A tube support should be used with this tubing for maximum holding power where end loading, vibration or pressure spikes may occur. Reference Tubing/Fitting Compatibility Chart (pg. B-6)

Notes

- The recommended operating temperature range for service at rated pressures with compatible fluids, depending upon conditions, is -54°C to +93°C (-65°F to +200°F)
- Black tubing suggested for use in sunlit areas and in close proximity to high ultraviolet light sources

Colors

- Natural
- Black

For detailed ordering information, please consult price list or contact Parflex® Division.

Nylon Pure Air Tubing

Series PAT: Ultra Pure, UV Resistant

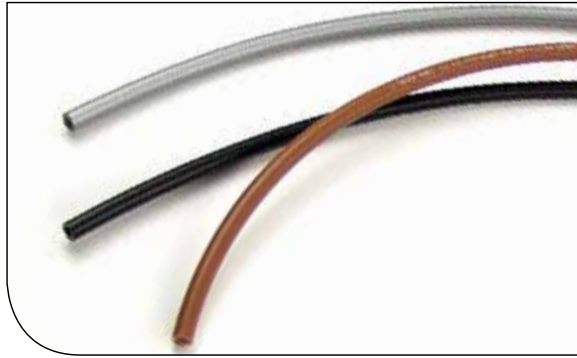

Features

- The tubing choice for pure air systems (semiconductor) due to its cleanliness and excellent chemical and UV light resistance
- Maintains good resistance to high ambient temperatures with low moisture absorption
- Manufactured from a specially formulated nylon for use in pure air and gas distribution systems
- Provides high tensile strength with excellent coupling retention in high pressure, temperature and vibration environments
- Sizes -2 and -4 are single wall tubing construction
- Sizes -6 through -12 are reinforced tubing construction

Applications/Markets



- Pure air and gas distribution systems
- Semi-conductor



Part Number	Tube O.D.		Tube I.D.		Average Wall Thickness		Working Pressure at 73°F /23°C		Minimum Burst at 73°F /23°C		Reel Length	Minimum Bend Radius		Weight	
	inch	mm	inch	mm	inch	mm	psi	bar	psi	bar		feet	inch	mm	lbs./ft.
#															
PAT2	1/8	3.2	.079	2.0	.023	0.58	250	17.2	1000	69.0	1000	.37	9.4	.035	.052
PAT4	1/4	6.4	.170	4.3	.040	1.0	300	20.7	1200	82.7	1000	1.00	25.4	.124	.185
PAT6	3/8	9.5	.251	6.4	.062	1.6	350	24.1	1400	96.4	500	1.50	38.1	.282	.420
PAT8	1/2	12.7	.376	9.6	.062	1.6	235	16.2	950	65.5	500	2.00	50.8	.395	.588
PAT10	5/8	15.9	.441	11.2	.092	2.3	225	15.5	900	62.1	250	2.50	63.5	.702	1.04
PAT12	3/4	19.1	.566	14.4	.092	2.3	200	13.8	800	55.2	250	3.00	76.2	.872	1.30



For detailed ordering information, please consult price list or contact Parflex® Division.

Order Information

Example: PAT4-BLK-0250

PAT4-BLK-0250 – Pure Air Tubing

PAT4-BLK-0250 – Tube O.D. in sixteenths of an inch (**1/4"**)

PAT4-BLK-0250 – Color (**Black**)

PAT4-BLK-0250 – Package Quantity in feet (**250'**)

Color Code		
●	BLK	Black
●	BRN	Brown
●	SIL	Silver

Pure Air Nylon Tubing (Series PAT)

Maximum Working Pressure (psig)

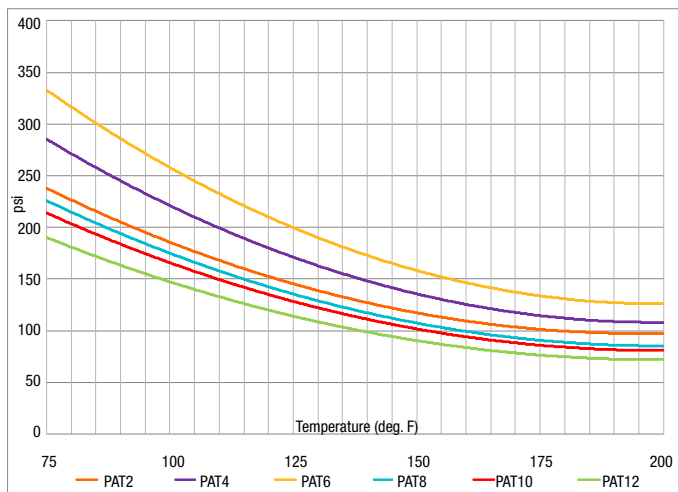

Fittings

Parker fittings available from:
Fluid System Connectors Division
Otsego, MI
(269) 692-6555
(269) 694-4614 FAX

FSC Product Families:

- Compression
- Compress-Align*
- Hi-Duty
- Fast & Tite
- NTA*

A tube support should be used with this tubing for maximum holding power where end loading, vibration or pressure spikes may occur. Reference Tubing/Fitting Compatibility Chart (pg. B-6)

Notes

- Packaged on corrugated plastic reel with ends capped and shipped in a plastic-lined container
- The suggested operating temperature range for service at rated pressures with compatible fluids is -70°F to +200°F (-57°C to +93°C)
- PAT tubing is rated for full vacuum service at 28 inch Hg

Colors

- See Color Code Table

Nylon Tubing

Series NR: Semi-rigid High Strength



Features

- High grade nylon resins without the addition of plasticizers for higher pressure tubing applications
- Better chemical resistance than Series N, good resistance to high ambient temperature and low moisture absorption
- High tensile strength and excellent coupling retention in high pressure, temperature and vibration environments

Applications/Markets



- High-pressure pneumatics and oils
- Lubrication systems
- Marine control systems
- Process lines for chemicals

Part Number	Part Number	Tube O.D.		Tube I.D.		Average Wall Thickness		Working Pressure at 73°F /23°C		Minimum Burst at 73°F /23°C		Reel Length	Minimum Bend Radius		Weight	
		inch	mm	inch	mm	inch	mm	psi	bar	psi	bar		feet	inch	mm	lbs./ft.
NNR-2-017	NBR-2-017	1/8	3.2	.091	2.3	.017	0.43	425	29.3	1700	117.2	0100, 0500	.50	12.7	.003	.005
NNR-2-026	NBR-2-026	1/8	3.2	.073	1.9	.026	0.66	625	43.1	2500	172.4	0100, 0500	.38	9.7	.004	.006
NNR-3-024	NBR-3-024	3/16	4.8	.140	3.6	.024	0.61	425	29.3	1700	117.2	0100, 0500	.75	19.0	.006	.009
NNR-3-039	NBR-3-039	3/16	4.8	.110	2.8	.039	0.99	625	43.1	2500	172.4	0100, 0500	.63	16.0	.008	.012
NNR-4-035	NBR-4-035	1/4	6.4	.180	4.6	.035	0.89	425	29.3	1700	117.2	0100, 0250	1.00	25.4	.011	.016
NNR-4-050	NBR-4-050	1/4	6.4	.150	3.9	.050	1.3	625	43.1	2500	172.4	0100, 0250	.88	22.3	.014	.021
NNR-5-040	NBR-5-040	5/16	7.9	.233	5.9	.040	1.0	425	29.3	1700	117.2	0100, 0250	1.50	38.1	.015	.022
NNR-6-048	NBR-6-048	3/8	9.5	.279	7.1	.048	1.2	425	29.3	1700	117.2	0100, 0250	1.75	44.5	.022	.033
NNR-6-075	NBR-6-075	3/8	9.5	.225	5.7	.075	1.9	625	43.1	2500	172.4	0100, 0250	1.50	38.1	.032	.048
NNR-8-062	NBR-8-062	1/2	12.7	.375	9.5	.062	1.6	375	26	1500	103.4	0100, 0250	2.38	60.5	.038	.057
NNR-8-075	NBR-8-075	1/2	12.7	.350	8.9	.075	1.9	625	43.1	2500	172.4	0100, 0250	2.50	63.5	.045	.067

Order Information

Example: NBR-2-017-0100

NBR-2-017-0100 – Nylon

NBR-2-017-0100 – Color (Black)

NBR-2-017-0100 – Rigid

NBR-2-017-0100 – Tube O.D. in sixteenths of an inch (**1/8"**)

NBR-2-017-0100 – Wall Thickness in inches (**.017"**)

NBR-2-017-0100 – Package Quantity in feet (**100'**)

(Omit for other package quantities)

Semi-rigid Nylon Tubing (Series NR)

Maximum Working Pressure (psig)

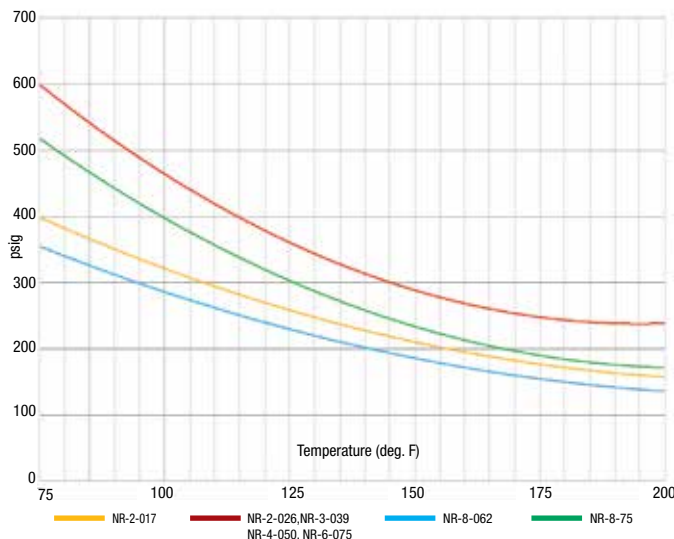

Fittings

Parker fittings available from:
Fluid System Connectors Division
Otsego, MI
(269) 692-6555
(269) 694-4614 FAX

FSC Product Families:

- Compression
- Compress-Align®
- Hi-Duty
- Fast & Tite
- Flow Control
- Prestolok Brass
- Prestolok Composite
- TrueSeal™

A tube support should be used with this tubing for maximum holding power where end loading, vibration or pressure spikes may occur. Reference Tubing/Fitting Compatibility Chart (pg. B-6)

Notes

- Suggested operating temperature range for service at rated pressures with compatible fluids is -60°F to +200°F (-51°C to +93°C)

Colors

- Natural
- Black

For detailed ordering information, please consult price list or contact Parflex® Division.

Nylon Tubing

Series NTNA: Semi-rigid Nylon Tubing

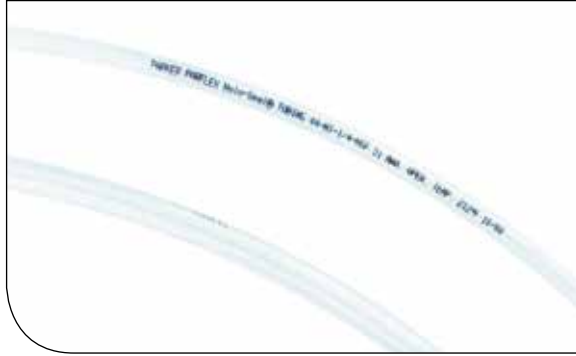

Features

- High grade nylon resins without the addition of plasticizers
- High tensile strength and excellent coupling retention in high pressure, temperature and vibration environments
- Excellent chemical resistance
- Rugged construction resists vermin attack

Certifications

- NSF-51

Applications/Markets



- Instrumentation lines
- Lubrication systems
- Process piping systems
- Refrigerant lines

Part Number	Tube O.D.		Tube I.D.		Average Wall Thickness		Working Pressure at 73°F / 23°C		Minimum Burst at 73°F / 23°C		Reel Length	Minimum Bend Radius		Weight		
	inch	mm	inch	mm	inch	mm	psi	bar	psi	bar		feet	inch	mm	lbs./ft.	kg./mtr.
#																
22NTNA	1/8	3.2	.091	2.3	.017	0.4	375	25.9	1,500	103.4	500	0.50	12.7	.003	.005	
532NTNA	5/32	4.0	.113	2.9	.022	0.6	375	25.9	1,500	103.4	500	0.63	16.0	.004	.006	
33NTNA	3/16	4.8	.139	3.5	.024	0.6	375	25.9	1,500	103.4	350	0.75	19.0	.006	.009	
44NTNA	1/4	6.4	.184	4.7	.033	0.8	375	25.9	1,500	103.4	200	1.00	25.4	.010	.015	
55NTNA	5/16	7.9	.232	5.8	.040	1.0	375	25.9	1,500	103.4	150	1.50	38.1	.015	.022	
66NTNA	3/8	9.5	.282	7.1	.048	1.2	375	25.9	1,500	103.4	100	1.75	44.4	.022	.033	
88NTNA	1/2	12.7	.375	9.5	.062	1.6	375	25.9	1,500	103.4	100	2.38	60.5	.032	.048	



For detailed ordering information, please consult price list or contact Parflex® Division.

Parker Hannifin Corporation | Parflex® Division | Ravenna, Ohio | parker.com/pfd

Order Information

Example: 44NTNA

44NTNA – Tube O.D. in sixteenths of an inch (1/4")

44NTNA – Nylon Tubing

44NTNA – Color (Natural)

Semi-rigid Nylon Tubing (Series NTNA)

Maximum Working Pressure (psig)

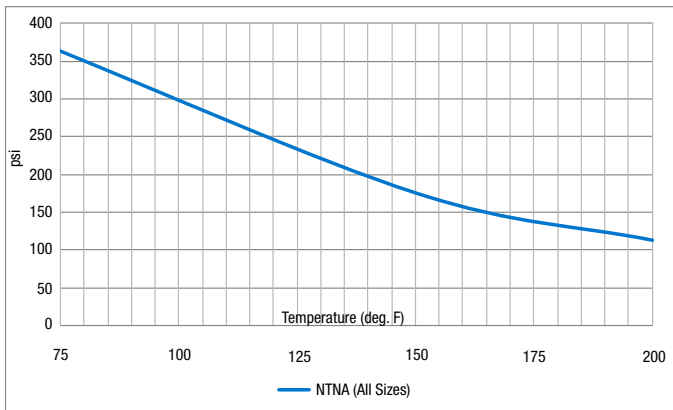

Fittings

Parker fittings available from:
Fluid System Connectors Division
Otsego, MI
(269) 692-6555
(269) 694-4614 FAX

FSC Product Families:

- Compression
- Compress-Align®
- Poly-Tite
- Hi-Duty
- Fast & Tite
- Flow Control
- NTA
- Prestolok Brass
- Prestolok Composite
- Prestomatic
- SAE Cartridges
- Transmission
- TrueSeal™

A tube support should be used with this tubing for maximum holding power where end loading, vibration or pressure spikes may occur. Reference Tubing/Fitting Compatibility Chart (pg. B-6)

Notes

- Suggested operating temperature range from -60°F to +212°F (-51°C to +100°C)

Colors

- Natural

For detailed ordering information, please consult price list or contact Parflex® Division.

TPE Parprene™ Tubing

Series G: General Industrial



Features

- Excellent flexural fatigue resistance
- Ozone and UV light resistant
- Temperatures from (-75°F to 275°F)
- Abrasion resistant
- Resistant to environmental stress cracking
- Lot-to-lot traceability
- Chemically compatible with common sanitizers and cleaners
- Extensive range of compatible Parker fittings and couplers

Applications/Markets



- Wastewater Sampling
- Cable Insulation
- Caustic Dispensing
- Ink and toner feed lines
- Chemical Transfer



Part Number	Tube O.D. (Ref.)		Tube I.D.		Wall Thickness		Maximum Working Pressure		Minimum Bend Radius		Standard Coil		Weight per 100 feet	
	inch	mm	inch	mm	inch	mm	psi	bar	inch	mm	feet	mtr.	lb.	kg.
#														
G64-31	0.188	5	0.062	2	0.062	1.59	34	2.34	1/4	6	50	15.2	1.03	0.47
G64-42	0.250	6	0.125	3	0.062	1.59	19	1.31	1/2	13	50	15.2	1.55	0.70
G64-53	0.312	8	0.188	5	0.062	1.59	13	0.90	3/4	19	50	15.2	2.06	0.93
G64-64	0.375	10	0.250	6	0.062	1.59	10	0.69	1-1/4	32	50	15.2	2.58	1.17
G64-75	0.438	11	0.312	8	0.062	1.59	8	0.55	1-1/2	38	50	15.2	3.10	1.41
G64-84	0.500	13	0.250	6	0.125	3.18	19	1.31	3/4	19	50	15.2	6.19	2.81
G64-86	0.500	13	0.375	10	0.062	1.59	7	0.48	2-1/4	57	50	15.2	3.61	1.64
G64-106	0.625	16	0.375	10	0.125	3.18	13	0.90	1-1/4	32	50	15.2	8.26	3.75
G64-128	0.750	19	0.500	13	0.125	3.18	10	0.69	2	51	50	15.2	10.32	4.68
G64-1410	0.875	22	0.625	16	0.125	3.18	8	0.55	3-1/4	83	50	15.2	12.39	5.62
G64-1612	1.000	25	0.750	19	0.125	3.18	7	0.48	4	102	50	15.2	14.45	6.56



For detailed ordering information, please consult price list or contact Parflex® Division.

Order Information

Example: G64-31

G64-31 – TPE, General Series

G64-31 – Hardness Durometer (64 Shore A)

G64-31 – Tube O.D. in sixteenths of an inch (3/16")

G64-31 – Tube I.D. in sixteenths of an inch (1/16")

Fittings

Parker fittings available from:
Fluid System Connectors Division
Otsego, MI
(269) 692-6555
(269) 694-4614 FAX

FSC Product Families:

- Par-Barb® Thermoplastic
- Dubl-Barb®
- Hose Barb

Couplings

Parker couplings available from:
Quick Coupling Division
Minneapolis, MN
(763) 544-7781
(763) 544-3418 FAX

QCD Product Families:

- Spectrum Series
- PPM Series
- PPL Series

Notes

- TPE is a thermoplastic elastomer formulated to withstand the rigors of peristaltic pump applications and yet, be safe enough for food and beverage applications.
- Suggested operating temperature range for service at rated pressures with compatible fluids is -75°F to +275°F (-59°C to 135°C)
- Packaged 50 foot coils - sealed clear polyethylene bag, barcoded, 1 per box for lot traceability
- Special lengths available, contact Parflex division

Colors

- Black

For detailed ordering information, please consult price list or contact Parflex® Division.

TPE Parprene™ Tubing

Series F: Food & Dairy



Features

- Excellent flexural fatigue resistance
- Ozone and UV light resistant
- Temperatures from (-75°F to 275°F)
- Abrasion resistant
- Resistant to environmental stress cracking
- Lot-to-lot traceability
- Chemically compatible with common sanitizers and cleaners
- Extensive range of compatible Parker fittings and couplers

Certifications

- FDA compliant for food contact
- NSF-51 Approved
- 3-A Approved

Applications/Markets



- Hot/Cold beverage dispensing
- Food and dairy processing lines
- Chemical transfer
- Water purification lines
- Soap dispensing



Part Number	Tube O.D. (Ref.)		Tube I.D.		Wall Thickness		Maximum Working Pressure		Minimum Bend Radius		Standard Coil		Weight per 100 feet		
	inch	mm	inch	mm	inch	mm	psi	bar	inch	mm	feet	mtr.	lb.	kg.	
#															
F64-31	0.188	5	0.062	2	0.062	1.59	34	2.34	1/4	6	50	15.2	1.03	0.47	
F64-42	0.250	6	0.125	3	0.062	1.59	19	1.31	1/2	13	50	15.2	1.55	0.70	
F64-53	0.312	8	0.188	5	0.062	1.59	13	0.90	3/4	19	50	15.2	2.06	0.93	
F64-64	0.375	10	0.250	6	0.062	1.59	10	0.69	1-1/4	32	50	15.2	2.58	1.17	
F64-75	0.438	11	0.312	8	0.062	1.59	19	1.31	1-1/2	38	50	15.2	3.10	1.41	
F64-84	0.500	13	0.250	6	0.125	3.18	8	0.55	3/4	19	50	15.2	6.19	2.81	
F64-86	0.500	13	0.375	10	0.062	1.59	7	0.48	2-1/4	57	50	15.2	3.61	1.64	
F64-106	0.625	16	0.375	10	0.125	3.18	13	0.90	1-1/4	32	50	15.2	8.26	3.75	
F64-128	0.750	19	0.500	13	0.125	3.18	10	0.69	2	51	50	15.2	10.32	4.68	
F64-1410	0.875	22	0.625	16	0.125	3.18	8	0.55	3-1/4	83	50	15.2	12.39	5.62	
F64-1612	1.000	25	0.750	19	0.125	3.18	7	0.48	4	102	50	15.2	14.45	6.56	

Order Information

Example: F64-31

F64-31 – TPE, General Series

F64-31 – Hardness Durometer (64 Shore A)

F64-31 – Tube O.D. in sixteenths of an inch (3/16")

F64-31 – Tube I.D. in sixteenths of an inch (1/16")

Fittings

Parker fittings available from:
Fluid System Connectors Division
Otsego, MI
(269) 692-6555
(269) 694-4614 FAX

FSC Product Families:

- Par-Barb® Thermoplastic
- Dubl-Barb®
- Hose Barb

Couplings

Parker couplings available from:
Quick Coupling Division
Minneapolis, MN
(763) 544-7781
(763) 544-3418 FAX

QCD Product Families:

- Spectrum Series
- PPM Series
- PPL Series

Notes

- TPE is a thermoplastic elastomer formulated to withstand the rigors of peristaltic pump applications and yet, be safe enough for food and beverage applications.
- Suggested operating temperature range for service at rated pressures with compatible fluids is -75°F to +275°F (-59°C to +135°C)
- Packaged 50 foot coils - sealed clear polyethylene bag, barcoded, 1 per box for lot traceability
- Special lengths available, contact Parflex division

Colors

- Tan

For detailed ordering information, please consult price list or contact Parflex® Division.

Polypropylene Tubing

Series PP: Laboratory Grade – FDA, NSF Listed
Series PPB: Ultraviolet Light Resistant



Features

- Acid and chemically resistant
- May be used in higher temperatures and working pressures than polyethylene tubing
- Excellent compatibility with high temperature water
- Low water absorption (less than .01%)
- Good compatibility with vegetable oils
- Excellent resistance to environmental stress cracking

Certifications

- FDA Both in white; NSF also in special black part numbers
- NSF-51

Applications/Markets



- Food contact - White only
- Chemical transfer
- Chlorinated water



Part Number	Part Number	Tube O.D.		Tube I.D.		Average Wall Thickness		Working Pressure at 73°F / 23°C		Minimum Burst at 73°F / 23°C		Reel Length	Minimum Bend Radius		Weight	
		inch	mm	inch	mm	inch	mm	psi	bar	psi	bar		feet	inch	mm	lbs./ft.
#	#															
White	Black	inch	mm	inch	mm	inch	mm	psi	bar	psi	bar	feet	inch	mm	lbs./ft.	kg./mtr.
PP-21-1000	PPB-21-1000	1/8	3.2	.079	2.0	.023	0.58	350	24.1	1400	96.4	1000	.50	12.7	.003	.005
PP-32-0500	PPB-32-0500	3/16	4.8	.120	3.1	.034	0.86	350	24.1	1400	96.4	0500	.75	14.4	.006	.009
PP-43-0500	PPB-43-0500	1/4	6.4	.170	4.3	.040	1.0	300	20.7	1200	82.7	0500	1.00	25.4	.010	.019
PP-53-0500	PPB-53-0500	5/16	7.9	.188	4.8	.062	1.6	350	24.1	1400	96.4	0500	1.25	31.8	.019	.028
PP-64-0500	PPB-64-0500	3/8	9.5	.250	6.4	.062	1.6	300	20.7	1200	82.7	0500	1.25	31.8	.024	.036
PP-86-0250	PPB-86-0250	1/2	12.7	.375	9.5	.062	1.6	225	15.5	900	62.1	0250	2.50	63.5	.033	.049
PP-108-0100	PPB-108-0100	5/8	15.9	.500	12.7	.062	1.6	175	12.1	700	48.3	0100	4.00	101.6	.042	.062



For detailed ordering information, please consult price list or contact Parflex® Division.

Order Information

Example: PP-86-0250

PP-86-0250 – Polypropylene

PP-86-0250 – **Tube O.D.** in sixteenths of an inch (**1/2"**)

PP-86-0250 – **Tube I.D.** in sixteenths of an inch (**.375"**)

PP-86-0250 – **Package Quantity** in feet (**250'**)

Polypropylene Tubing (Series PP & PPB)

Maximum Working Pressure (psig)

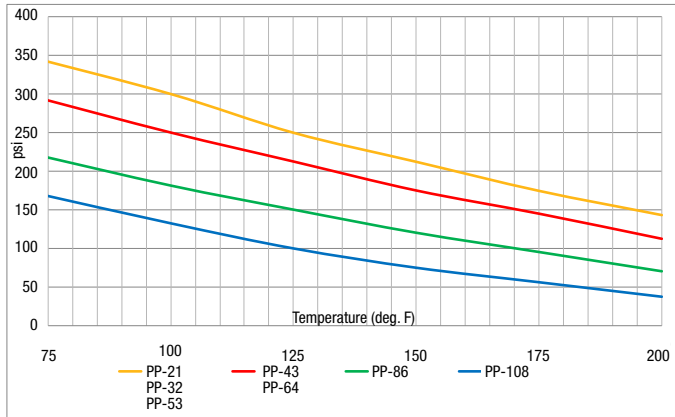

Fittings

Parker fittings available from:
 Fluid System Connectors Division
 Otsego, MI
 (269) 692-6555
 (269) 694-4614 FAX

FSC Product Families:

- Compression
- Compress-Align®
- Poly-Tite
- Hi-Duty
- Fast & Tite
- Prestolok Brass
- Liquifit
- TrueSeal™

A tube support should be used with this tubing for maximum holding power where end loading, vibration or pressure spikes may occur. Reference Tubing/Fitting Compatibility Chart (pg. B-6)

Notes

- NSF black polypropylene tubing is available upon special request. Add -FDA suffix to PPB part number
- Suggested operating temperature range for service at rated pressures with compatible fluids is 0°F to +200°F (-18°C to +93°C)

Colors

- White
- Black

For detailed ordering information, please consult price list or contact Parflex® Division.

Polyurethane Tubing

Series U: Polyether Base



Features

- 90 to 95 Shore A durometer
- Excellent kink and abrasion resistance
- Excellent hydrolytic stability
- Flexible and easy to assemble onto designated fittings
- Polyurethane tubing exhibits the elongation and recovery characteristics of rubber and the chemical resistance associated with plastics

Applications/Markets



- Pneumatic controls
- Robotics
- Machine tools

- Analytical instrumentation
- Semiconductor equipment
- Medical and laboratory applications



- General pneumatics
- Vacuum equipment

Part Number	Tube O.D.		Tube I.D.		Average Wall Thickness		Working Pressure at 73°F / 23°C		Minimum Burst at 73°F / 23°C		Reel Length	Weight	
	inch	mm	inch	mm	inch	mm	psi	bar	psi	bar		feet	lbs./ft.
#													
	Natural												
U-21-XXXX	1/8	3.2	.063	1.6	.031	0.79	125	8.6	375	25.9	0050, 0250, 0500, 1000	.005	.007
U-32-XXXX	3/16	4.8	.125	3.2	.031	0.79	125	8.6	375	25.9	0050, 0250, 0500	.008	.012
U-42-XXXX	1/4	6.4	.125	3.2	.063	1.6	125	8.6	375	25.9	0050, 0250, 0500, 1000	.018	.027
U-64-XXXX	3/8	9.5	.250	6.4	.063	1.6	125	8.6	375	25.9	0050, 0250, 0500, 1000	.030	.045
U-85-XXXX	1/2	12.7	.328	8.3	.086	2.2	125	8.6	375	25.9	0050, 0250, 0500	.044	.065
U-86-XXXX	1/2	12.7	.375	9.5	.063	1.6	85	5.9	255	17.6	0050, 0250, 0500	.042	.062
U-96-XXXX	9/16	14.3	.375	9.5	.094	2.4	125	8.6	375	25.9	0050, 0100	.068	.101
U-128-XXXX	3/4	19.1	.500	12.7	.125	3.2	125	8.6	375	25.9	0050, 0100	.120	.179

Also available in coils



For detailed ordering information, please consult price list or contact Parflex® Division.

Parker Hannifin Corporation | Parflex® Division | Ravenna, Ohio | parker.com/pfd

Order Information

Example: U-21-BLK-0500

U-21-BLK-0500 – Polyurethane

U-21-BLK-0500 – **Tube O.D.** in sixteenths of an inch (**1/8"**)

U-21-BLK-0500 – **Tube I.D.** in sixteenths of an inch (**.063"**)

U-21-**BLK**-0500 – **Color (Black)** (Omit for Natural)

U-21-BLK-**0500** – **Package Quantity** in feet (**500'**)

Opaque Color Code		
○	-	Natural
●	BLK	Black
●	BLU	Blue
●	GRA	Gray
●	GRN	Green
●	ORG	Orange
●	RED	Red
○	WHT	White
●	YEL	Yellow

Transparent Color Code		
●	TBLU	Transparent Blue
●	TGRN	Transparent Green
●	TORG	Transparent Orange
●	TRED	Transparent Red
●	TYEL	Transparent Yellow

Polyurethane Tubing (Series U)

Maximum Working Pressure (psig)

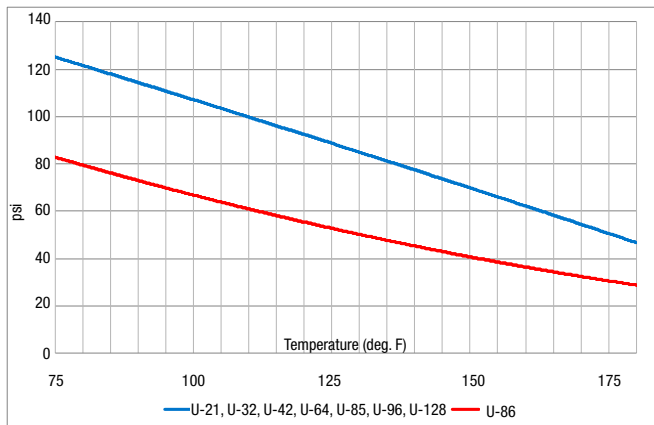

Fittings

Parker fittings available from:
Fluid System Connectors Division
Otsego, MI
(269) 692-6555
(269) 694-4614 FAX

FSC Product Families:

- Fast & Tite
- Flow Control
- Prestolok Brass
- Prestolok Composite
- TrueSeal™
- Par-Barb®

A tube support should be used with this tubing for maximum holding power where end loading, vibration or pressure spikes may occur. Reference Tubing/Fitting Compatibility Chart (pg. B-6)

Notes

- Suggested operating temperature range for service at rated pressures with compatible fluids is -40°F to +180°F (-40°C to +82°C)

Colors

- See Color Code Table

Metric Polyurethane Tubing

Series UM: Polyether Base

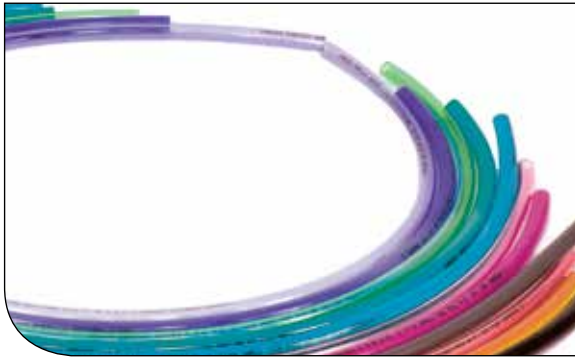

Features

- 90 to 95 Shore A durometer
- Excellent kink and abrasion resistance
- Excellent hydrolytic stability
- Flexible and easy to assemble onto designated fittings
- Polyurethane tubing exhibits the elongation and recovery characteristics of rubber and the chemical resistance associated with plastics

Applications/Markets



- Pneumatic controls
- Robotics
- Machine tools

- Analytical instrumentation
- Semiconductor equipment
- Medical and laboratory applications



- General pneumatics
- Vacuum equipment

Part Number	Tube O.D.		Tube I.D.		Average Wall Thickness		Working Pressure at 73°F /23°C		Minimum Burst at 73°F /23°C		Reel Length	Weight	
	mm	inch	mm	inch	mm	inch	bar	psi	bar	psi		feet	kg./mtr.
#													
Natural	mm	inch	mm	inch	mm	inch	bar	psi	bar	psi	feet	kg./mtr.	lbs./ft.
UM4x2.5-XXXX	4	.157	2.5	.098	0.75	.030	9.0	131	26.0	377	0100, 0250, 0500	.009	.006
UM6x4-XXXX	6	.236	4.0	.157	1.00	.039	9.0	131	26.0	377	0100, 0250, 0500	.018	.012
UM8x5-XXXX	8	.315	5.0	.196	1.50	.059	9.0	131	26.0	377	0100, 0250, 0500	.036	.024
UM10x6.5-XXXX	10	.393	6.5	.256	1.75	.069	9.0	131	26.0	377	0100, 0250	.053	.036
UM12x8-XXXX	12	.472	8.0	.315	2.00	.079	9.0	131	26.0	377	0100, 0250	.073	.049

Order Information

Example: UM6x4-BLK-0100

UM6X4-BLK-0100 – Polyurethane Metric

UM6X4-BLK-0100 – **Tube O.D.** in millimeters (**6 mm**)

UM6X4-BLK-0100 – **Tube I.D.** in millimeters (**4 mm**)

UM6X4-**BLK**-0100 – **Color (Black)** (Omit for Natural)

UM6X4-BLK-**0100** – **Package Quantity** in feet (**100'**)

Opaque Color Code		
○	-	Natural
●	BLK	Black
●	BLU	Blue
●	GRA	Gray
●	GRN	Green
●	ORG	Orange
●	RED	Red
●	YEL	Yellow

Transparent Color Code		
●	TBLU	Transparent Blue
●	TGRN	Transparent Green
●	TORG	Transparent Orange
●	TRED	Transparent Red
●	TYEL	Transparent Yellow

Fittings

Parker fittings available from:
Fluid System Connectors Division
Otsego, MI
(269) 692-6555
(269) 694-4614 FAX

FSC Product Families:

- Prestolok Brass
- Par-Barb

A tube support should be used with this tubing for maximum holding power where end loading, vibration or pressure spikes may occur. Reference Tubing/Fitting Compatibility Chart (pg. B-6)

Notes

- The recommended operating temperature range for service at rated pressures with compatible fluids is -40°F to +180°F (-40°C to +82°C)

Colors

- See Color Code Table

Metric Polyurethane Tubing (Series UM)

Maximum Working Pressure (bar)

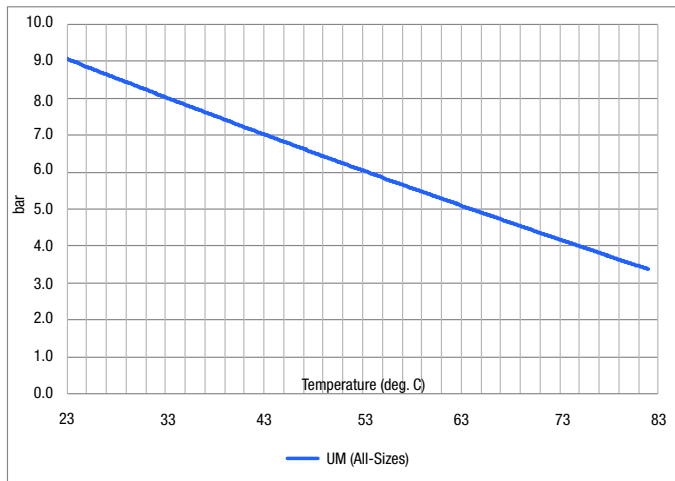

For detailed ordering information, please consult price list or contact Parflex® Division.

HUFR MicroWeld™ Tubing

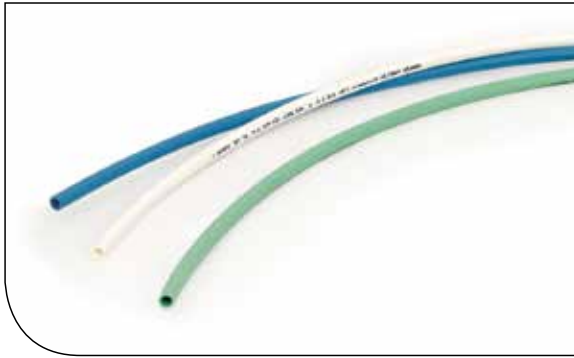

Features

- Mono-wall construction eliminates the need for skiving tools or knives, reducing installation time
- Excellent abrasion resistance
- Silicone and halogen free
- Weighs 36% less than equivalent covered tubing

Certifications

- UL 94 V2 compliant

Applications/Markets



- Robotics
- Welding
- General automation

Part Number	Tube O.D.		Tube I.D.		Average Wall Thickness		Working Pressure at 73°F / 23°C		Minimum Burst at 73°F / 23°C		Reel Length	Minimum Bend Radius		Weight	
	inch	mm	inch	mm	inch	mm	psi	bar	psi	bar		feet	inch	mm	lbs./ft.
#															
HUFR-4-045-XX-0500	1/4	6.4	.160	4.1	.045	1.1	175	12.1	525	36.2	0500	.50	12.7	.016	.024
HUFR-6-062-XX-0500	3/8	9.5	.251	6.4	.062	1.6	150	10.3	450	31.0	0500	.75	19.1	.033	.049
HUFR-8-090-XX-0250	1/2	12.7	.320	8.1	.090	2.3	160	11.0	475	32.7	0250	1.00	25.4	.063	.094

Order Information

Example: HUFR-4-045-BL-0500

HUFR-4-045-BL-0500 – MicroWeld™ Polyurethane

HUFR-**4**-045-BL-0500 – **Tube O.D.** in sixteenths of an inch (**1/4"**)

HUFR-4-**045**-BL-0500 – **Wall Thickness** in inches (**.045"**)

HUFR-4-045-**BL**-0500 – **Color (Blue)**

HUFR-4-045-BL-**0500** – **Package Quantity** in feet (**500'**)

Color Code		
●	BK	Black
●	BL	Blue
●	GN	Green
●	RD	Red
○	WH	White

Fittings

Parker fittings available from:
Fluid System Connectors Division
Otsego, MI
(269) 692-6555
(269) 694-4614 FAX

FSC Product Families:

- Prestolok PLM

Notes

- Suggested operating temperature range for service at rated pressures with compatible fluids is -40°F to +180°F (-40°C to +82°C)

Colors

- See Color Code Table

MicroWeld™ Tubing (Series HUFR)

Maximum Working Pressure (psig)

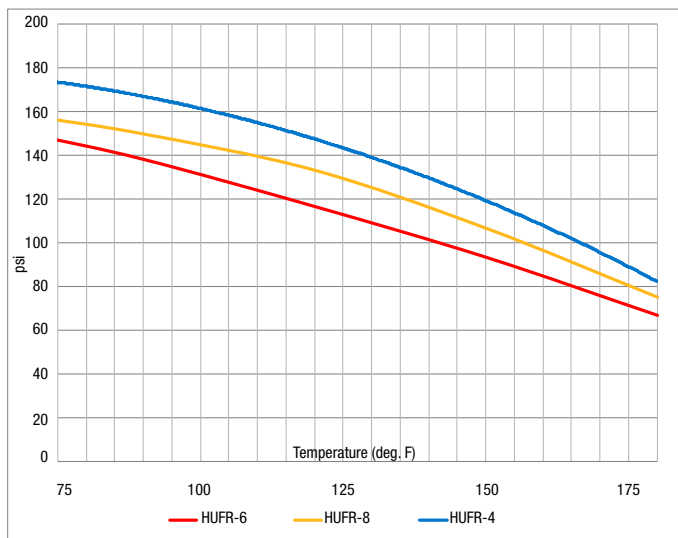

For detailed ordering information, please consult price list or contact Parflex® Division.



Polyurethane Tubing

Series HU: High Durometer Polyether Base



Features

- 95 Shore A durometer or greater
- Excellent kink and abrasion resistance
- Excellent hydrolytic stability
- Flexible and easy to assemble onto designated fittings
- Polyurethane tubing exhibits the elongation and recovery characteristics of rubber and the chemical resistance associated with plastics

Applications/Markets



- Pneumatic controls
- Robotics
- Machine tools

- Analytical instrumentation
- Semiconductor equipment
- Medical and laboratory applications



- General pneumatics
- Vacuum equipment

Part Number	Tube O.D.		Tube I.D.		Average Wall Thickness		Working Pressure at 73°F / 23°C		Minimum Burst at 73°F / 23°C		Reel Length	Weight	
	inch	mm	inch	mm	inch	mm	psi	bar	psi	bar		feet	lbs./ft.
#													
HU-2-XXXX	1/8	3.2	.063	1.6	.031	0.79	300	20.7	900	62.1	0100, 0250, 0500	.005	.007
HU-2.5-XXXX	5/32	4.0	.094	2.4	.031	0.79	210	14.5	630	43.4	0100, 0500	.006	.009
HU-4-XXXX	1/4	6.4	.160	4.1	.045	1.1	180	12.4	540	37.2	0100, 0500	.014	.021
HU-6-XXXX	3/8	9.5	.250	6.4	.062	1.6	180	12.4	540	37.2	0100, 0500	.030	.045
HU-8-XXXX	1/2	12.7	.320	8.1	.090	2.3	180	12.4	540	37.2	0100, 0250	.057	.085
HU-12-XXXX	3/4	19.1	.467	11.9	.142	3.6	180	12.4	540	37.2	0100, 0250	.133	.198

Order Information

Example: HU-2-BLK-0500

HU-2-BLK-0500 – High Durometer Polyurethane

HU-2-BLK-0500 – Tube O.D. in sixteenths of an inch **(1/8")**

HU-2-BLK-0500 – Color (Black)

HU-2-BLK-0500 – Package Quantity in feet **(500')**

Color Code		
●	BLK	Black
●	BLU	Blue
●	DBL	Dark Blue
●	RED	Red
●	YEL	Yellow

Polyurethane Tubing (Series HU)

Maximum Working Pressure (psig)

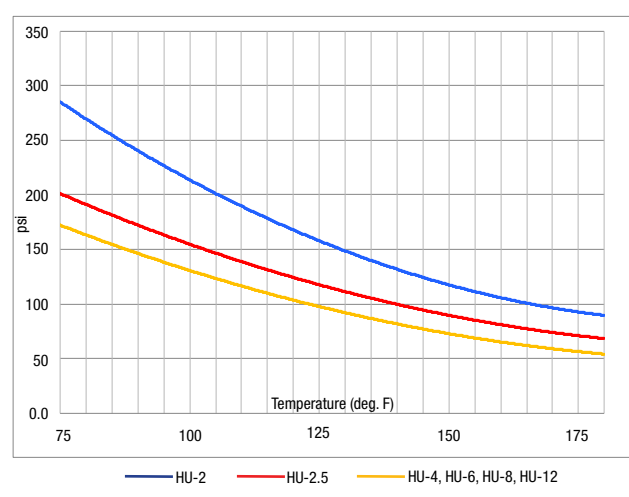

Fittings

Parker fittings available from:
Fluid System Connectors Division
Otsego, MI
(269) 692-6555
(269) 694-4614 FAX

FSC Product Families:

- Fast & Tite
- Flow Control
- Prestolok Brass
- Prestolok Composite
- TrueSeal™

A tube support should be used with this tubing for maximum holding power where end loading, vibration or pressure spikes may occur. Reference Tubing/Fitting Compatibility Chart (pg. B-6)

Notes

- Suggested operating temperature range for service at rated pressures with compatible fluids is -40°F to +180°F (-40°C to +82°C)

Colors

- See Color Code Table

For detailed ordering information, please consult price list or contact Parflex® Division.



Metric Polyurethane Tubing

Series HUM: High Durometer (Metric) Polyether Base



Features

- 95 Shore A durometer or greater
- Excellent kink and abrasion resistance
- Excellent hydrolytic stability
- Flexible and easy to assemble onto designated fittings
- Polyurethane tubing exhibits the elongation and recovery characteristics of rubber and the chemical resistance associated with plastics

Applications/Markets



- Pneumatic controls
- Robotics
- Machine tools

- Analytical instrumentation
- Semiconductor equipment
- Medical and laboratory applications



- General pneumatics
- Vacuum equipment

Part Number	Tube O.D.		Tube I.D.		Average Wall Thickness		Working Pressure at 73°F / 23°C		Minimum Burst at 73°F / 23°C		Reel Length	Weight	
	mm	inch	mm	inch	mm	inch	bar	psi	bar	psi		feet	kg./mtr.
#													
HUM-4-XXXX	4	.157	2.4	.094	0.80	.031	12.4	180	37.2	540	0100, 0500	.009	.006
HUM-6-XXXX	6	.236	4.0	.157	1.00	.039	12.4	180	37.2	540	0100, 0500	.018	.012
HUM-8-XXXX	8	.315	5.0	.196	1.50	.059	12.4	180	37.2	540	0100, 0500	.036	.024
HUM-10-XXXX	10	.393	6.5	.256	1.75	.069	12.4	180	37.2	540	0100, 0250	.053	.036
HUM-12-XXXX	12	.472	8.0	.315	2.00	.079	12.4	180	37.2	540	0100, 0250	.073	.049



For detailed ordering information, please consult price list or contact Parflex® Division.

Order Information

Example: HUM-6-BLK-0100

HUM-6-BLK-0100 – High Durometer Metric Polyurethane

HUM-6-BLK-0100 – **Tube O.D.** in millimeters (**6mm**)

HUM-6-**BLK**-0100 – **Color (Black)**

HUM-6-BLK-**0100** – **Package Quantity** in feet (**100'**)

Metric Polyurethane Tubing (Series HUM)

Maximum Working Pressure (bar)

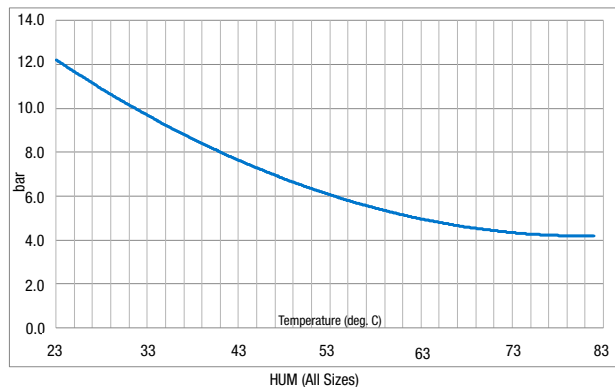

Fittings

Parker fittings available from:
Fluid System Connectors Division
Otsego, MI
(269) 692-6555
(269) 694-4614 FAX

FSC Product Families:

- Flow Control
- Prestolok Brass
- Prestolok Composite

A tube support should be used with this tubing for maximum holding power where end loading, vibration or pressure spikes may occur. Reference Tubing/Fitting Compatibility Chart (pg. B-6)

Notes

- Suggested operating temperature range for service at rated pressures with compatible fluids is -40°F to +180°F (-40°C to +82°C)

Colors

- Natural
- Black

For detailed ordering information, please consult price list or contact Parflex® Division.

Parker Hannifin Corporation | Parflex® Division | Ravenna, Ohio | parker.com/pfd



B-43

A
Hose

B
Tubing
Thermoplastic

C
Coiled Air Hose
& Fittings

D
Transportation

E
Fittings

F
Tooling, Equipment
& Accessories

G
General Technical

Vinyl Tubing

Series PV: Clear Vinyl Tubing



Features

- Made from a virgin clear PVC (polyvinyl chloride) resin; specifically formulated for exceptional purity, clarity and flexibility
- 70 durometer for soft, easy handling and bending without tubing collapse

Certifications

- FDA compliant

Applications/Markets



- Low-pressure chemicals
- Pneumatics
- Low-pressure sight flow indicator

Order Information

Example: PV108-1

PV108-1 – Poly-Vinyl Tubing

PV108-1 – **Tube O.D.** in sixteenths of an inch (**5/8"**)

PV108-1 – **Tube I.D.** in sixteenths of an inch (**1/2"**)

PV108-1 – **Formula V-1 FDA Approved Formulation**

Fittings

Parker fittings available from:
Fluid System Connectors Division
Otsego, MI
(269) 692-6555
(269) 694-4614 FAX

FSC Product Families:

- Poly-Tite
- Fast & Tite
- TrueSeal™
- Par-Barb®
- Hose Barb
- Garden Fitting

A tube support should be used with this tubing for maximum holding power where end loading, vibration or pressure spikes may occur. Reference Tubing/Fitting Compatibility Chart (pg. B-6)







Notes

- Formula V-1 tubing fully meets all specifications called out by the United States Food and Drug Administration (FDA) for materials in contact with food and drugs for human consumption
- Suggested operating temperature range for service at rated pressures with compatible fluids is -40°F to +150°F (-40°C to +65°C)



For detailed ordering information, please consult price list or contact Parflex® Division.

Parker Hannifin Corporation | Parflex® Division | Ravenna, Ohio | parker.com/pfd

Part Number	Tube O.D.		Tube I.D.		Average Wall Thickness		Working Pressure at 73°F / 23°C		Std. Coil	Weight	
	inch	mm	inch	mm	inch	mm	psi	bar		feet	lbs./ft.
#											
PV21-1	1/8	3.2	.063	1.6	.031	.79	35	2.4	100	.005	.007
PV32-1	.170	4.3	.125	3.2	.025	.64	35	2.4	100	.006	.009
PV42-1	1/4	6.4	.125	3.2	.063	1.6	65	4.5	100	.025	.037
PV43-1	1/4	6.4	.170	4.3	.040	1.2	55	3.8	100	.014	.021
PV403-1	1/4	6.4	.188	4.8	.031	.79	22	1.5	100	.011	.016
PV53-1	5/16	7.9	.188	4.8	.063	1.6	55	3.8	100	.025	.037
PV63-1	3/8	9.5	.188	4.8	.094	2.4	65	4.5	100	.043	.064
PV73-1	7/16	11.1	.188	4.8	.125	3.2	75	5.2	100	.063	.094
PV54-1	5/16	7.9	.250	6.4	.031	.79	20	1.4	100	.014	.021
PV64-1	3/8	9.5	.250	6.4	.064	1.6	55	3.8	100	.032	.048
PV74-1	7/16	11.1	.250	6.4	.094	2.4	60	4.1	100	.052	.077
PV84-1	1/2	12.7	.250	6.4	.125	3.2	70	4.8	100	.076	.113
PV75-1	7/16	11.1	.313	7.9	.063	1.6	50	3.4	100	.038	.057
PV85-1	1/2	12.7	.313	7.9	.094	2.4	60	4.1	100	.062	.092
PV95-1	9/16	14.3	.313	7.9	.125	3.2	70	4.8	100	.088	.131
PV86-1	1/2	12.7	.375	9.5	.063	1.6	45	3.1	100	.044	.065
PV96-1	9/16	14.3	.375	9.5	.094	2.4	50	3.4	100	.071	.106
PV106-1	5/8	15.9	.375	9.5	.125	3.2	60	4.1	100	.101	.150
PV97-1	9/16	14.3	.438	11.1	.063	1.6	40	2.8	100	.050	.074
PV107-1	5/8	15.9	.438	11.1	.094	2.4	45	3.1	100	.080	.119
PV117-1	11/16	17.5	.438	11.1	.125	3.2	50	3.4	100	.115	.171
PV108-1	5/8	15.9	.500	12.7	.063	1.6	30	2.1	100	.057	.085
PV118-1	11/16	17.5	.500	12.7	.094	2.4	40	2.8	100	.089	.132
PV128-1	3/4	19.1	.500	12.7	.125	3.2	45	3.1	100	.126	.187
PV138-1	13/16	20.7	.500	12.7	.156	4.0	60	4.1	100	.167	.248
PV129-1	3/4	19.1	.563	14.3	.094	2.4	40	2.8	100	.099	.147
PV139-1	13/16	20.7	.563	14.3	.125	3.2	45	3.1	100	.138	.205

For detailed ordering information, please consult price list or contact Parflex® Division.



Vinyl Tubing (cont.)

Series PV: Clear Vinyl Tubing

Part Number	Tube O.D.		Tube I.D.		Average Wall Thickness		Working Pressure at 73°F / 23°C		Std. Coil	Weight	
	inch	mm	inch	mm	inch	mm	psi	bar		feet	lbs./ft.
#											
PV1310-1	13/16	26.7	.625	15.9	.094	2.4	35	2.4	100	.108	.161
PV1410-1	7/8	22.2	.625	15.9	.125	3.2	40	2.8	100	.151	.225
PV1510-1	15/16	23.8	.625	15.9	.156	4.0	50	3.5	100	.196	.292
PV1411-1	7/8	22.2	.688	17.5	.094	2.4	30	2.1	100	.118	.176
PV1611-1	1	25.4	.688	17.5	.156	4.0	45	3.1	100	.213	.317
PV1612-1	1	25.4	.750	19.1	.125	3.2	35	2.4	100	.176	.262
PV1712-1	1-1/16	27.0	.750	19.1	.156	4.0	35	2.4	100	.228	.339
PV1812-1	1-1/8	28.6	.750	19.1	.188	4.8	50	3.5	100	.283	.421
PV2012-1	1-1/4	31.8	.750	19.1	.250	6.4	55	3.8	50	.409	.609
PV1814-1	1-1/8	27.0	.875	22.2	.125	3.2	30	2.1	50	.201	.299
PV1914-1	1-3/16	30.2	.875	22.2	.156	4.0	35	2.4	100	.259	.385
PV2014-1	1-1/4	31.8	.875	22.2	.188	4.8	45	3.1	50	.321	.478
PV2016-1	1-1/4	31.8	1.000	25.4	.125	3.2	25	1.7	50	.230	.342
PV2116-1	1-5/16	33.4	1.000	25.4	.156	4.0	30	2.1	50	.291	.433
PV2216-1	1-3/8	34.9	1.000	25.4	.188	4.8	40	2.8	50	.359	.534
PV2416-1	1-1/2	38.1	1.000	25.4	.250	6.4	45	3.1	50	.514	.765
PV2218-1	1-3/8	34.9	1.125	28.6	.125	3.2	25	1.7	50	.252	.375
PV2420-1	1-1/2	38.1	1.250	31.8	.125	3.2	20	1.4	50	.277	.412
PV2620-1	1-5/8	41.3	1.250	31.8	.188	4.8	35	2.4	50	.434	.646
PV2820-1	1-3/4	44.4	1.250	31.8	.250	6.4	45	3.1	50	.604	.899
PV3024-1	1-7/8	47.6	1.500	38.1	.188	4.8	30	2.1	50	.510	.759
PV3224-1	2	50.8	1.500	38.1	.250	6.4	40	2.8	50	.705	1.05
PV3628-1	2-1/4	57.2	1.750	44.4	.250	6.4	30	2.1	50	.806	1.20
PV4032-1	2-1/2	63.5	2.000	50.8	.250	6.4	35	2.4	50	.906	1.35

Fluoropolymer Tubing

Fluoropolymer Tubing

Fluoropolymer tubing features a low coefficient of friction and anti-stick properties, high temperature capabilities and the most corrosion and chemical resistance of all polymers. Within normal use temperatures, fluoropolymers are attacked by so few chemicals that it is easier to describe the exceptions rather than list the chemicals they are compatible with (see Chemical Resistance Summary, pg. B-50). These chemically inert tubes are non-wetting and non-leaching, making them ideal for a wide range of fluid and material handling applications.

Parker fluoropolymer tubing is available in PTFE, FEP, PFA and PVDF with some materials operating at temperatures up to 500°F (260°C). Each material has specific dominant characteristics, but all operate in high-temperature, corrosive environments.

- Parflex PTFE, FEP, PFA and PVDF tubing complies with European Standard RoHs and are also FDA compliant to FDA regulation 21 CFR 177.1550, making these products suitable for use in food and beverage applications.
- Parflex PTFE, FEP and PFA are listed VW-1 in the burning test for Underwriters Laboratories and pass the UL-83 vertical flame test. In a flame situation, PTFE, FEP and PFA tubing resist combustion and do not promote flame spread.

All fluoropolymer tubing dimensions are continuously monitored to ensure an overall quality product. Most tubing sizes are packaged in convenient 25-ft., 50-ft., 100-ft. and 1,000-ft. lengths.

PTFE

- PTFE (Polytetrafluorethylene) is offered in beading, smoothbore tubing, heat shrinkable, spiral wrap and convoluted tubing.
- PTFE tubing features unmatched chemical resistance and a non-stick surface that facilitates flow and eliminates media buildup.

FEP

- FEP (Fluorinated Ethylene Propylene) is available in smoothbore tubing, heat shrinkable, convoluted, corrugated and retractable coil tubing.
- FEP tubing offers the highest clarity in the fluoropolymer market and is a close second to PTFE in chemical resistance.
- FEP is available in long, continuous lengths (1,000 feet and longer) whereas the longest lengths for PTFE range from 200 to 1,000 feet depending on size and wall thickness.

PFA

- PFA (Perfluoroalkoxy) is available in smoothbore tubing.
- When temperature and clarity are both factors, PFA is the resin of choice because it offers the high-temperature attributes of PTFE, long continuous lengths, and almost as much clarity as FEP.
- High purity resins available.
- Low permeability.

Fluoropolymer Tubing

Product Family	Type	Series		Suggested Applications		Suggested Markets
PTFE	Beading	TFB		Pull Cord O-Ring Seals	Spacers Woven Filter	Chemical High-Temp Food Instrumentation Laboratory Gas Sampling Electrical Insulation Fluid Handling Industrial Equipment Ground Support
	Smoothbore	TFH TFS	TFT TFL	Electrical Insulation Protective Cover	Circuit Board Wire Insulation	
	Smoothbore	101	201	Electrical Insulation Fluid Transfer	Gas Sampling Laboratory	
	Heat Shrink	HS2T	HS4T TSSS/L	Electrical Insulation Protective Cover	Circuit Board Rollers	
	Convuluted	CV CVL	CVH 81914	Fluid Transport Wire Harness	Protection/Cable Core Robotics	
	Spiral Wrap	TSWTF		Cable Harnessing	Wiring closets	Aerospace Automotive
FEP	Smoothbore	103	203	Nitrogen Filling Downhole Pump Ozone Sampling	Hearing Aid Optical Sensors	UV Applications Chemical Instrumentation Laboratory Gas Dispensing Gas Sampling Robotics Fluid Handling Food & Beverage Semiconductor Pharmaceutical Electrical Industrial Equipment Medical
	Heat Shrink	HS1.3 HS1.6 HS1.25	TSSS TSSL	Protective Covering UV Light Covering Product Testing	Paper Rollers Ink Rollers	
	Convuluted	CV	81914	Fluid Transport Wire Harness	Protection/Cable Core Robotics	
	Corrugated	CR		Vacuum Applications Wet Bench DNA Sequencer	Fluid Transfer Robotics	
	Retractable	703		Lab Equipment Gas Dispensing	Wet Bench Dual Containment	
PFA	Smoothbore	104	204	Air Sampling Gas Purge Wet Bench	Flow Monitoring Steam Plant	Chemical Laboratory Semiconductor Instrumentation Food Environmental Fluid Handling Gas Service Pharmaceutical Medical
H.P. PFA	Smoothbore	105	205	Flow Monitoring Systems High Purity Apps. DI Water Dispensers	DI Recirculators Heat Exchangers Pure Chemical Dispensers	
PFA H.P. PFA	Retractable	704	705	Lab Equipment Gas Dispensing	Wet Bench Dual Containment	
PVDF	Smoothbore	110	111	Outdoor/Extreme Conditions Applications with long cycle life	Thermal Cycling Water Systems	Chemical Food Gas/Environmental

High Purity PFA

- H.P. PFA (Perfluoroalkoxy) has the highest molecular weight available.
- Withstands corrosive surfactants for longer periods of time than standard products.
- Lowest level of extractables.

PVDF

- PVDF (Polyvinylidene Fluoride) is available in flexible and super flexible smoothbore tubing.
- PVDF offers a combination of properties beneficial for use in many critical applications requiring chemical resistance with low permeability.
- PVDF exhibits low extractable levels while providing high mechanical strength and abrasion resistance.

For detailed ordering information, please consult price list or contact Parflex® Division.

Fluoropolymer Tubing

Tubing
Fluoropolymer
B

Coiled Air Hose
& Fittings
C

Transportation
D

Fittings
E

Tooling, Equipment
& Accessories
F

General Technical
G

Fluoropolymer - Quick Reference

PTFE (Polytetrafluoroethylene)
Working Temperature: 500°F (260°C)
Color: Opaque to translucent

- Chemically inert
- Lowest coefficient of friction
- Superior dielectric strength
- Exceptional heat resistance
- Self extinguishing
- Non-wetting
- Excellent flexlife
- Laser markable

PFA (Perfluoroalkoxy)
Working Temperature: 500°F (260°C)
Color: Clear with light blue or tint

- High purity resins available
- Low permeation resins available
- Use when you need the temperature range of PTFE and the clarity of FEP
- Exceptional heat resistance
- Self extinguishing
- Non-wetting
- Good flexlife

FEP (Fluorinated Ethylene Propylene)
Working Temperature: 400°F (204°C)
Color: Clear

- Excellent chemical resistance
- Non-wetting
- Weldable
- Tubes can be sealed by melting
- Long continuous lengths
- Low refractive index
- Improved clarity over PFA
- Lower cost alternative to PFA

PVDF (Polyvinylidene Fluoride)
Working Temperature: 265°F (130°C)
Color: Varies

- Very good chemical resistance
- Excellent resistance to creep and fatigue
- UV Resistant
- Weldable
- Exceptional corrosion resistance for chlorine, fluorine, or bromine environments

Chemical Resistance Summary



Within normal use temperatures, fluoroplastics are attacked by so few chemicals that it is easier to describe the exceptions rather than list the chemicals with which TexFluor™ is compatible.

DO NOT USE FLUOROPLASTICS WITH THE FOLLOWING:

- Alkali metals such as elemental sodium, potassium, lithium, etc. The alkali metals remove fluorine from the polymer molecule.
- Extremely potent oxidizers, fluorine (F2) and related compounds (e.g., chlorine trifluoride, ClF3). These can be handled by TexFluor™, but only with great care, as fluorine is absorbed into the resins, and the mixture becomes sensitive to a source of ignition such as impact.
- 80% NaOH (Sodium Hydroxide) or KOH (Potassium Hydroxide), metal hydrides such as Boranes (e.g., B2H6), Aluminum Chloride, Ammonia (NH3), certain Amines (R-NH2) and imines (R=NH) and 70% Nitric Acid at temperatures near the suggested service limit.



WARNING

FAILURE OR IMPROPER SELECTION OR IMPROPER USE OF THE PRODUCTS AND/OR SYSTEMS DESCRIBED HEREIN OR RELATED ITEMS CAN CAUSE DEATH, PERSONAL INJURY AND PROPERTY DAMAGE.

This document and other information from Parker Hannifin Corporation, its subsidiaries and authorized distributors provide product and/or system options for further investigation by users having technical expertise. It is important that you analyze all aspects of your application and review the information concerning the product or system in the current product catalog. Due to the variety of operating conditions and applications for these products or systems, the user, through its own analysis and testing, is solely responsible for making the final selection of the products and systems and assuring that all performance, safety and warning requirements of the application are met.

The products described herein, including without limitation, product features, specifications, designs, availability and pricing, are subject to change by Parker Hannifin Corporation and its subsidiaries at any time without notice.



Fluoropolymer Tubing

The table below lists a generally accepted summary of properties that we believe to be reliable. Please note that many of these resins are produced in several varieties and property characteristics may vary. Therefore, determination of resin is dependent on the application and this table is only meant to serve as a general guideline.

Properties*	ASTM or Unit	PTFE	FEP	PFA	High Purity PFA	PVDF	ETFE
MECHANICAL PROPERTIES							
Specific Gravity	D792 D3307	2.13-2.22 -	2.12-2.17 -	2.12-2.17 -	- 2.14-2.16	1.76-1.82 -	1.74 -
Elongation %	D638 D3307	200-450 -	250-330 -	280-400 -	- 370	100-800 -	430 -
Tensile Strength (psi)	D638(psi) D3307(psi)	2000-7000 -	2800-4000 -	4000-5000 -	- 4693	2000-5000 -	6962 -
Flexural Strength (psi)	D790	no break	no break	no break	no break	1500-5000	5500
Compressive Strength (psi)	D695	700-900	725-2200	725-810	na	2000-6000	2500
Tensile Elastic Modulus (Young's Modulus) (psi)	D638	57,000 -	50,000 -	72,500- 87,000	na	35,000-220,000	116,030
Flexural Modulus	D790(psi) D790 103MPa (103kgf/cm2)	71,000-85,000 0.5-0.6 (5.0-6.0)	78,000-92,000 0.5-0.6 (5.5-6.4)	94,000-99,000 0.6-0.7 (6.6-7.0)	- 647-686 -	90,000-168,000 280,00-110,000	130,534 - -
Flex Life (MIT cycles)	D2176	>1,000,000	5,000-80,000	10,000-500,000	2000 x 10 ³	na	na
Hardness Durometer Shore D	D2240	D50-65	D55	D55-D60	D60	D55-D75	D67
Coefficient of Friction	(on steel)	0.02	0.05	0.04-0.06	0.05	0.33-0.49	0.20
Abrasion Resistance 1000 cycles	Taber	8-90	14-20	0.00-96.75	na	16-33	0.005
Impact Strength IZO.D. 73°F (23°C) notched ft/lbs/in	D256	3	no break	no break	no break	4	no break
THERMAL PROPERTIES							
Melting Point	°C °F	327 621	260 500	305 582	305 582	125 257	260 500
Upper Service Temperature(20000h)	°C °F	260 500	204 400	260 500	260 500	130 265	180 356
Flammability	UL 94	V-0	V-0	V-0	V-0	V-0	V-0
Thermal Conductivity BTU-in/hr-ft ² , °F		1.7-2.08	1.4	1.3	na	1.00-1.25	1.65
Thermal Conductivity Cal-cm/sec-cm ² , °C		6 x 10 ⁻⁴	6 x 10 ⁻⁴	6 x 10 ⁻⁶	na	na	5.7 x 10 ⁻⁴
Linear Coefficient of Thermal Expansion Min/in°F 73.4-140°F	D696	55.6	46.1-58.3	66.7	na	7.00-10.8	9.4 (10 ⁻⁵ /°C)
Heat of Fusion	BTU/LB	29-37	4-35	13	na	0.28-0.36	20
Heat of Combustion	BTU/LB °F	2200	2200	2300	na	na	8100
Low Temperature Embrittlement	°C °F	-268 -450	-268 -450	-268 -450	-268 -450	-62 -80	-76 -105
ELECTRICAL PROPERTIES							
Dielectric Constant	D150/10 ³ Hz D150/10 ⁶ Hz	2.1 2.1	2.1 2.1	2.1 2.1	2.1 2.1	3.5 10.6	2.6
Dielectric Strength	D149/125 MIL D149/10 MIL	500 ≥1400	508 >610	500 ≥1400	500 - 600 na	0.8 1.5	na
Volume Resistivity	D257/ohm-cm	>10 ¹⁸	>10 ¹⁸	>10 ¹⁸	na	2 x 10 ¹⁴	10 ¹⁷
Surface Resistivity	D257/ohm-cm	>10 ¹⁸	>10 ¹⁷	>10 ¹⁷	na	5 x 10 ¹⁴	>10 ¹⁵
GENERAL PROPERTIES							
Chemical/Solvent Resistance	D543	Excellent	Excellent	Excellent	Excellent	Very Good	Excellent
Refractive Index		1.35	1.338	1.34	1.34	1.42	1.447
Limiting Oxygen Index, %	D2868	>95	>95	≥95	na	42/75 ²	31
Water Contact Angle	Angle to Level	110	114	115	na	92	na
Water Absorption 24h,%	D570	<0.01	<0.01	<0.03	<0.01	0.03-0.05	0.03
Weatherability		Excellent	Excellent	Excellent	Excellent	Excellent	Excellent

*General resin properties; Tubing properties may vary.

Tubing Pressure Ranges

Tubing pressures vary by material, tubing size and wall thickness. Please contact Customer Service for specific pressures.

For detailed ordering information, please consult price list or contact Parflex® Division.

Parker Hannifin Corporation | Parflex® Division | Ravenna, Ohio | parker.com/pfd



B-51

Tubing
Fluoropolymer
B

Coiled Air Hose
& Fittings
C

Transportation
D

Fittings
E

Tooling, Equipment
& Accessories
F

General Technical
G

Fluoropolymer Tubing

Fluoropolymer Tubing Nomenclature Smoothbore Fractional and Metric Tubing

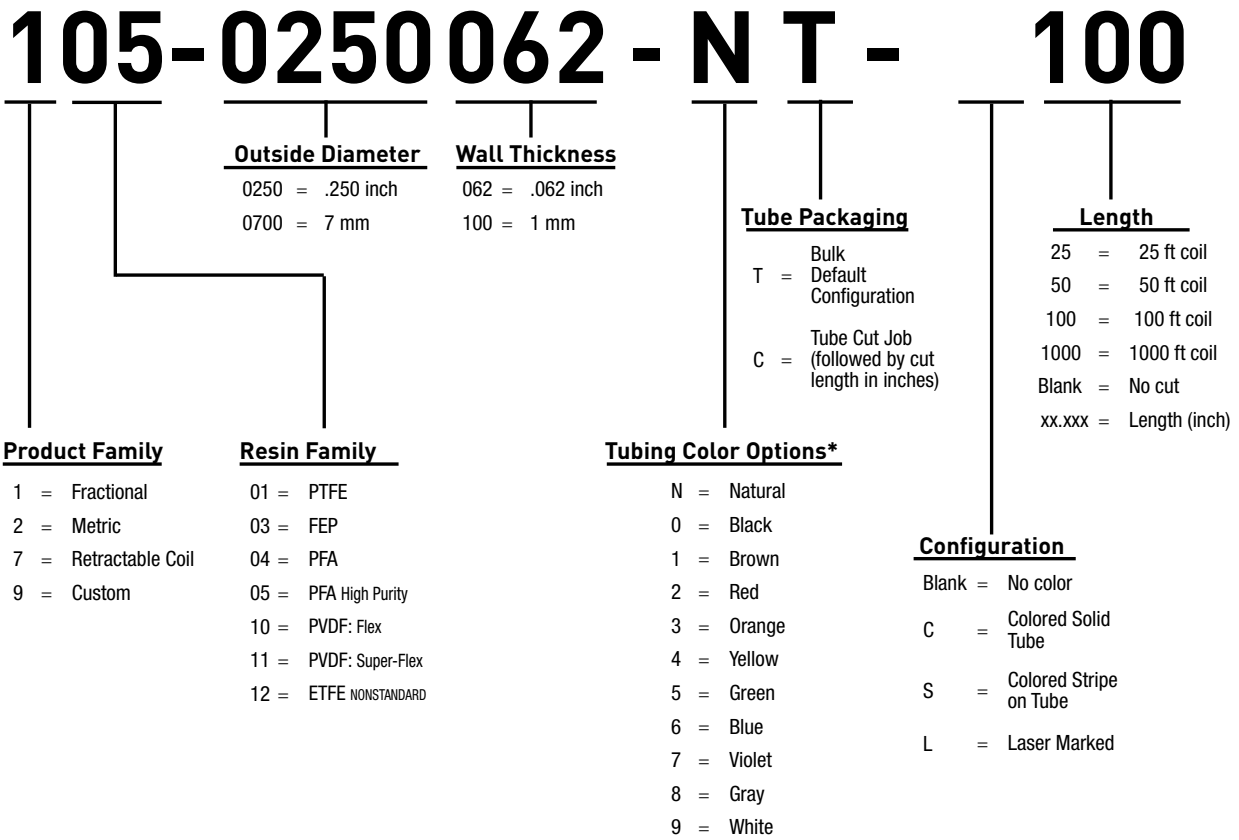

Convolute and Corrugated Tubing

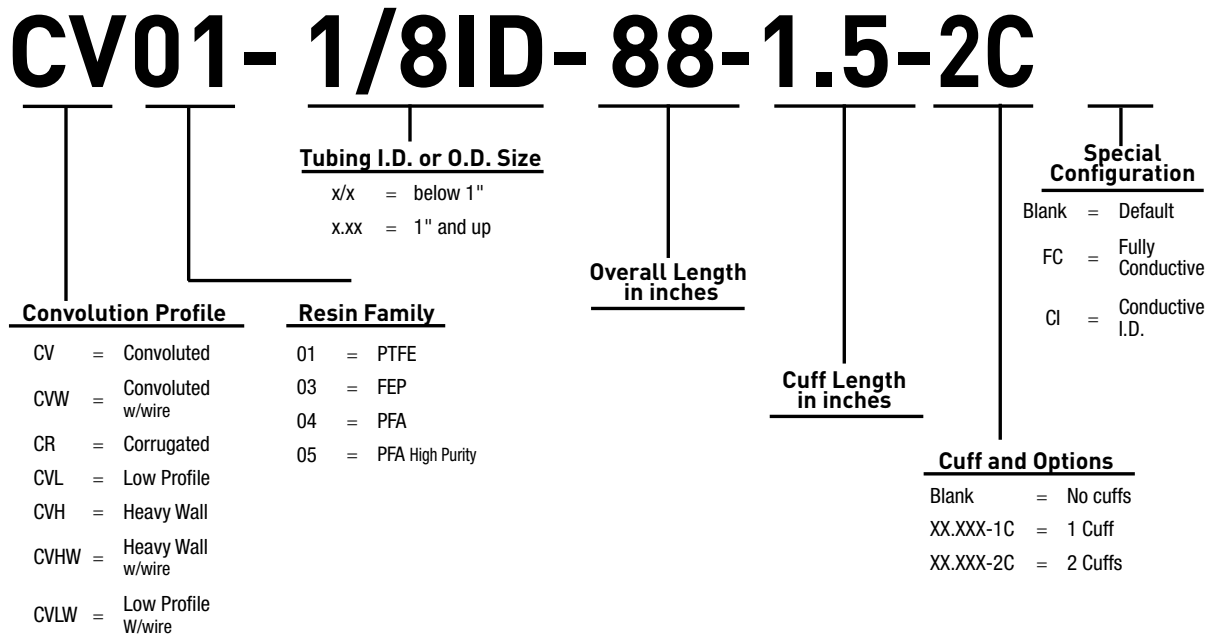

For detailed ordering information, please consult price list or contact Parflex® Division.

Parker Hannifin Corporation | Parflex® Division | Ravenna, Ohio | parker.com/pfd

Fluoropolymer Tubing

Fluoropolymer Tubing Nomenclature

Heat Shrink, Electrical Insulation Tubing and Beading

HS2** T F T 1/8 - N T***

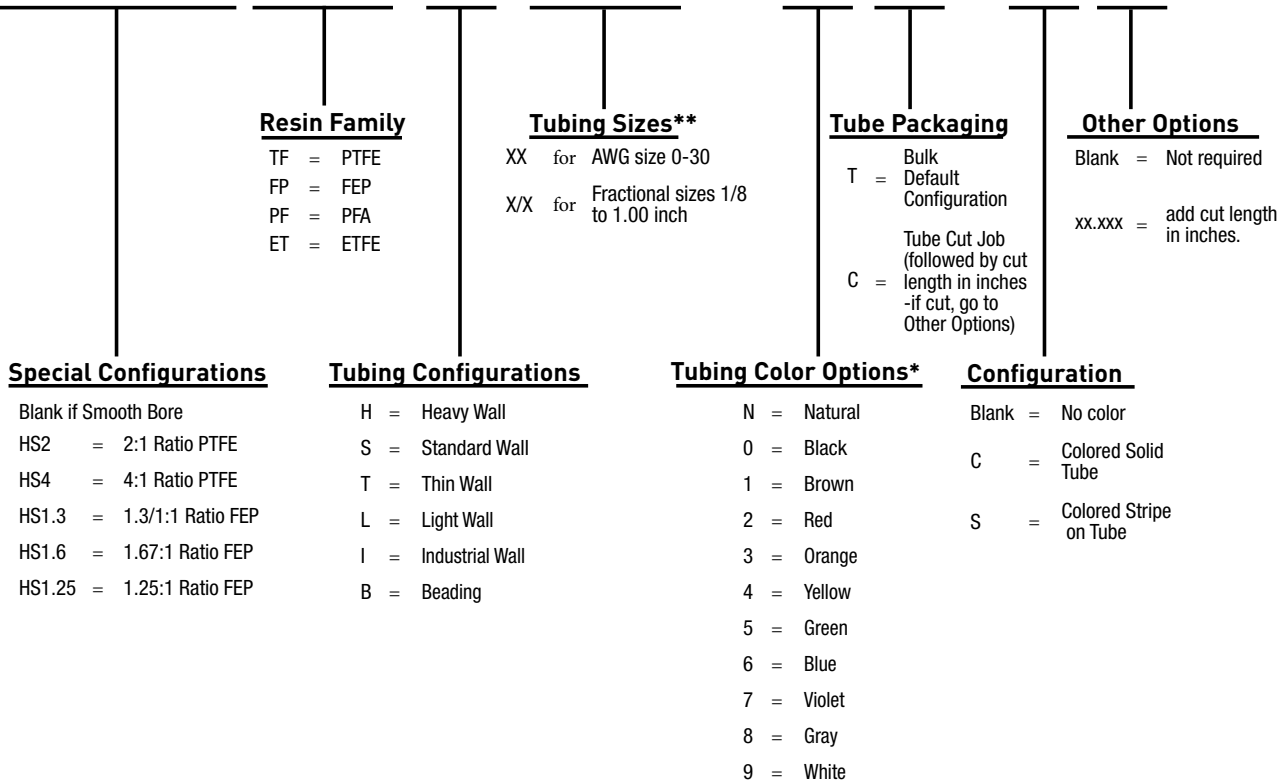

*When ordering coiled tubing in colors, the color code is always followed by TC; when ordering cut lengths, the color code is followed by CC....ie HS2TFT1/8-2TC ..ie HS1.3FEP24-OCC48.000

**This first configuration is only used for heat shrinkable tubing or spiral wrap. For example, electrical insulation tubing part number would read TFT-1/8-NT.

***When changing to cut length, replace the T with C and specify the length in inches. If this part was cut to 4 feet, part number would read TFT-1/8-NC48.000.

****Sizes for heat shrink designate the size of the heat shrink tube as stated by the applicable specification. The actual O.D. of the tubing does not always match the size. Review actual tables to see the true expanded dimension of the tube.

For detailed ordering information, please consult price list or contact Parflex® Division.



PTFE Tubing

Series Fractional & Metric: 101, 201



Features

- Virgin Polytetrafluoroethylene resin
- Chemically inert
- Lowest coefficient of friction
- Superior dielectric strength
- Exceptional heat resistance
- Self extinguishing
- Non-wetting
- Excellent flexlife
- Laser markable

Applications/Markets



- Cable Liner
- Electrical Insulation
- Oxygen Sensor
- Paint Transfer
- Gas Sampling
- Laboratory



Certifications/Compliance

- AMS 3653E
- VW1, UL-83 (natural)
- FDA Compliant
- USP Class VI Compliant

Order Information

Example: 101-0188062-0TC-100

101-0188062-0TC-100 – **PTFE**

101-**0188**062-0TC-100 – **Tube O.D.** in inches (**3/16"**)

101-0188**062**-0TC-100 – **Tube Wall Thickness** in inches (**.062"**)

101-0188062-**0TC**-100 – **Black**

101-0188062-**0TC**-100 – **Bulk Tubing**

101-0188062-**0TC**-100 – **Solid Color Tube**

101-0188062-0TC-**100** – **Package Quantity** in feet (**100'**)

Notes

- Working Temperature: 500°F (260°C)
- Working pressure calculated using a Design Factor of 4
- Custom packaging and sizes are quoted upon request
- Package quantities are not continuous

Colors

- ○ Natural, Translucent
- Colors available as custom run, see color code table

Fittings

Fittings available for sizes 3/32" up to 1.1"

Parker Fittings available from:
Fluid System Connectors Division
Otsego, MI

(269) 694-2550

(269) 692-6634 FAX

FSC Product Families:

- Compression
- Compress-Align®
- TrueSeal™

Color Code					
○	N	Natural	●	5	Green
●	0	Black	●	6	Blue
●	1	Brown	●	7	Violet
●	2	Red	●	8	Gray
●	3	Orange	○	9	White
●	4	Yellow			

101 PTFE Industrial Wall Fractional Size Tubing

Part Number	Order Size	Nominal O.D.				Nominal I.D.				Reference Wall		Working Pressure		Burst Pressure		Min. Bend Radius		Vac. Rating		Weight	
		inch	inch	tol.	mm	tol.	inch	tol.	mm	tol.	inch	mm	psi 73°F	bar 23°C	psi 73°F	bar 23°C	inch	mm	at 73°F	lb. per ft.	kg. per m.
#																					
101-0094031	3/32	0.094	± 0.005	2.40	± 0.13	0.031	± 0.002	0.79	± 0.05	0.031	0.79	390	27	1560	108	0.500	13	28	0.006	0.009	
101-0125031	1/8	0.125	± 0.005	3.18	± 0.13	0.063	± 0.003	1.57	± 0.05	0.031	0.79	290	20	1160	80	0.500	13	28	0.009	0.013	
101-0156031	5/32	0.156	± 0.005	3.99	± 0.13	0.094	± 0.004	2.39	± 0.08	0.031	0.79	220	15	880	61	0.625	16	28	0.011	0.017	
101-0188031	3/16	0.188	± 0.005	4.78	± 0.13	0.125	± 0.005	3.18	± 0.13	0.031	0.79	180	12	720	50	0.750	19	28	0.014	0.021	
101-0250031	1/4	0.250	± 0.005	6.35	± 0.13	0.190	± 0.005	4.83	± 0.13	0.031	0.79	130	9	520	36	1.000	25	28	0.020	0.030	
101-0312031	5/16	0.312	± 0.005	7.92	± 0.13	0.250	± 0.007	6.35	± 0.18	0.031	0.79	100	7	400	28	2.250	57	28	0.026	0.038	
101-0375031	3/8	0.375	± 0.005	9.52	± 0.13	0.312	± 0.006	7.92	± 0.15	0.031	0.79	80	6	320	22	2.750	70	28	0.032	0.047	
101-0438031	7/16	0.438	± 0.005	11.13	± 0.13	0.375	± 0.007	9.52	± 0.18	0.031	0.79	70	5	280	19	4.000	102	28	0.037	0.056	
101-0500031	1/2	0.500	± 0.006	12.70	± 0.15	0.438	± 0.008	11.13	± 0.20	0.031	0.79	60	4	240	17	4.000	102	28	0.043	0.064	
101-0563031	9/16	0.563	± 0.007	14.30	± 0.18	0.500	± 0.010	12.70	± 0.25	0.031	0.79	55	4	220	15	5.000	127	28	0.049	0.073	
101-0625031	5/8	0.625	± 0.007	15.88	± 0.18	0.563	± 0.010	14.30	± 0.25	0.031	0.79	50	3	200	14	5.500	140	28	0.054	0.081	
101-0688031	11/16	0.688	± 0.010	17.48	± 0.25	0.625	± 0.012	15.88	± 0.31	0.031	0.79	45	3	180	12	6.250	159	28	0.060	0.090	
101-0750032	3/4	0.750	± 0.010	19.05	± 0.25	0.688	± 0.012	17.48	± 0.31	0.032	0.81	40	3	160	11	6.500	165	28	0.068	0.101	
101-0830040	0.830	0.830	± 0.014	21.08	± 0.36	0.750	± 0.014	19.05	± 0.36	0.040	1.02	45	3	180	12	8.000	203	28	0.093	0.139	
101-0965045	0.965	0.965	± 0.016	24.51	± 0.41	0.875	± 0.016	22.22	± 0.41	0.045	1.14	45	3	180	12	12.000	305	28	0.122	0.182	
101-1100050	1.100	1.100	± 0.020	27.94	± 0.51	1.000	± 0.020	25.40	± 0.51	0.050	1.27	40	3	160	11	18.000	457	28	0.155	0.231	

Continued on next page

For detailed ordering information, please consult price list or contact Parflex® Division.



PTFE Tubing

Series Fractional & Metric: 101, 201 (cont.)

101 PTFE Heavy Wall Fractional Size Tubing

Part Number	Order Size	Nominal O.D.				Nominal I.D.				Reference Wall		Working Pressure		Burst Pressure		Min. Bend Radius		Vac. Rating	Weight	
		inch	inch	tol.	mm	tol.	inch	tol.	mm	tol.	inch	mm	psi 73°F	bar 23°C	psi 73°F	bar 23°C	inch		mm	at 73°F
#																				
101-0188062	3/16	.188	±.005	4.78	±0.13	0.063	±0.003	1.57	±0.05	0.062	1.57	390	27	1560	108	0.250	6	28	0.023	0.034
101-0250047	1/4	.250	±.005	6.35	±0.13	0.157	±0.005	3.99	±0.13	0.047	1.19	210	14	840	58	0.625	16	28	0.028	0.042
101-0250062	1/4	.250	±.005	6.35	±0.13	0.125	±0.005	3.18	±0.13	0.062	1.57	290	20	1160	80	0.500	13	28	0.034	0.051
101-0312062	5/16	.312	±.005	7.92	±0.13	0.188	±0.006	4.76	±0.15	0.062	1.57	222	15	888	61	0.875	22	28	0.046	0.068
101-0375062	3/8	.375	±.005	9.52	±0.13	0.250	±0.005	6.35	±0.13	0.062	1.57	180	12	720	50	1.000	25	28	0.057	0.085
101-0438062	7/16	.438	±.005	11.13	±0.13	0.312	±0.007	7.92	±0.18	0.062	1.57	150	10	600	41	2.250	57	28	0.069	0.103
101-0500062	1/2	.500	±.005	12.70	±0.13	0.375	±0.005	9.52	±0.13	0.062	1.57	130	9	520	36	2.250	57	28	0.080	0.120
101-0563062	9/16	.563	±.007	14.30	±0.18	0.437	±0.008	11.13	±0.20	0.062	1.57	110	8	440	30	2.750	70	28	0.092	0.137
101-0625062	5/8	.625	±.007	15.88	±0.18	0.500	±0.010	12.70	±0.25	0.062	1.57	100	7	400	28	3.000	76	28	0.103	0.154
101-0688062	11/16	.688	±.010	17.48	±0.25	0.563	±0.010	14.30	±0.25	0.062	1.57	90	6	360	25	5.000	127	28	0.115	0.171
101-0750062	3/4	.750	±.010	19.05	±0.25	0.625	±0.010	15.88	±0.25	0.062	1.57	80	6	320	22	6.000	152	28	0.126	0.188
101-0875062	7/8	.875	±.014	22.22	±0.36	0.750	±0.014	19.05	±0.36	0.062	1.57	70	5	280	19	7.250	184	28	0.149	0.222
101-1000062	1	1.000	±.016	25.40	±0.25	0.875	±0.016	22.22	±0.36	0.062	1.57	100	6.9	400	28	8.000	203	28	0.172	0.256



For detailed ordering information, please consult price list or contact Parflex® Division.

201 Metric PTFE Tubing

Part Number	Order Size	Nominal O.D.				Nominal I.D.				Reference Wall		Working Pressure		Burst Pressure		Min. Bend Radius		Vac. Rating		Weight	
		mm	mm	tol.	inch	tol.	mm	tol.	inch	tol.	mm	inch	bar 23°C	psi 73°F	bar 23°C	psi 73°F	mm	inch	at 73°F	kg. per m.	lb. per ft.
#																					
201-0300100	3	3	± 0.11	0.118	± 0.004	1	± 0.11	0.039	± 0.004	1	0.039	390	27	108	1560	13	0.500	28	0.014	0.009	
201-0400100	4	4	± 0.11	0.157	± 0.004	2	± 0.11	0.074	± 0.004	1	0.039	290	20	80	1160	13	0.500	28	0.020	0.014	
201-0500100	5	5	± 0.11	0.197	± 0.004	3	± 0.11	0.118	± 0.004	1	0.039	220	15	61	880	19	0.750	28	0.027	0.018	
201-0600100	6	6	± 0.13	0.236	± 0.005	4	± 0.13	0.157	± 0.005	1	0.039	180	12	50	720	25	1.000	28	0.034	0.023	
201-0700100	7	7	± 0.13	0.276	± 0.005	5	± 0.13	0.197	± 0.005	1	0.039	150	10	41	600	38	1.500	28	0.041	0.027	
201-0800100	8	8	± 0.13	0.315	± 0.005	6	± 0.13	0.236	± 0.005	1	0.039	130	9	36	520	51	2.000	28	0.048	0.032	
201-0900100	9	9	± 0.13	0.354	± 0.005	7	± 0.13	0.276	± 0.005	1	0.039	110	8	30	440	57	2.250	28	0.055	0.037	
201-1000100	10	10	± 0.13	0.394	± 0.005	8	± 0.13	0.315	± 0.005	1	0.039	100	7	28	400	64	2.500	28	0.061	0.041	
201-1200100	12	12	± 0.15	0.472	± 0.006	10	± 0.15	0.394	± 0.006	1	0.039	80	6	22	320	76	3.000	28	0.075	0.050	
201-1400100	14	14	± 0.15	0.551	± 0.006	12	± 0.15	0.472	± 0.006	1	0.039	70	5	19	280	89	3.500	28	0.089	0.060	
201-1600100	16	16	± 0.15	0.630	± 0.006	14	± 0.15	0.551	± 0.006	1	0.039	60	4	17	240	108	4.250	28	0.102	0.069	

For detailed ordering information, please consult price list or contact Parflex® Division.



PTFE Tubing

Series Fractional: TFL, TFS, TFT



Features

- Virgin Polytetrafluoroethylene resin
- Chemically inert
- Lowest coefficient of friction
- Superior dielectric strength
- Exceptional heat resistance
- Self extinguishing
- Non-wetting
- Excellent flexlife
- Laser markable

Applications/Markets



- Electrical Insulation
- Protective Cover
- Cable Liner
- Spacer

Certifications/Compliance

- AMS 3653E
- VW1, UL-83 (natural)
- FDA Compliant
- USP Class VI Compliant
- **Light Wall** (TFL) – ASTM D3295 Class 1, AMS 3654C
- **Thin Wall** (TFT) – ASTM D3295 Class 2, AMS 3655B
- **Standard Wall** (TFS) – ASTM D3295 Class 3, MIL-I-22129C

Order Information

Example: TFS1/2-NT

TFS1/2-NT – PTFE

TFS1/2-NT – Standard Wall

TFS1/2-NT – Tube O.D. in inches (1/2")

TFS1/2-NT – Natural

TFS1/2-NT – Bulk Tubing

Notes

- Working Temperature: 500°F (260°C)
- Package quantities are not continuous - Fractional tubing is supplied in random length coils, with a minimum coil length of 15 feet.
- Custom packaging, sizes and lengths are quoted upon request.

Colors

- ○ Natural, Translucent
- Colors available as custom run, see color code table

Fittings

Fittings available for sizes 3/32" up to 1.1"

Parker Fittings available from:
Fluid System Connectors Division
Otsego, MI

(269) 694-2550

(269) 692-6634 FAX





FSC Product Families:

- TrueSeal™

Color Code

○	N	Natural	●	5	Green
●	0	Black	●	6	Blue
●	1	Brown	●	7	Violet
●	2	Red	●	8	Gray
●	3	Orange	○	9	White
●	4	Yellow			

TFS, TFT & TFL PTFE Fractional Tubing

Size			Nominal I.D.		Standard Wall			Thin Wall			Light Wall			Standard Packaging
					Part Number	Nominal Wall		Part Number	Nominal Wall		Part Number	Nominal Wall		
					# 			# 			# 			
inch	inch	mm	Natural	inch	mm	Natural	inch	mm	Natural	inch	mm			
1/8	0.125	3.18	TFS1/8	0.020	0.51	TFT1/8	0.015	0.38	TFL1/8	0.008	0.20	Random Length Coil		
3/16	0.188	4.78	TFS3/16	0.020	0.51	TFT3/16	0.015	0.38	TFL3/16	0.010	0.25	Random Length Coil		
1/4	0.250	6.35	TFS1/4	0.020	0.51	TFT1/4	0.015	0.38	TFL1/4	0.010	0.25	Random Length Coil		
5/16	0.318	7.92	TFS5/16	0.020	0.51	TFT5/16	0.015	0.38	TFL5/16	0.012	0.30	Random Length Coil		
3/8	0.381	9.52	TFS3/8	0.025	0.64	TFT3/8	0.015	0.38	TFL3/8	0.015	0.38	Random Length Coil		
7/16	0.444	11.13	TFS7/16	0.025	0.64	TFT7/16	0.018	0.46	TFL7/16	0.018	0.46	Random Length Coil		
1/2	0.507	12.70	TFS1/2	0.025	0.64	TFT1/2	0.018	0.46	TFL1/2	0.018	0.46	Random Length Coil		
5/8	0.632	15.88	TFS5/8	0.025	0.64	TFT5/8	0.020	0.51	-	-	-	Random Length Coil		
3/4	0.760	19.05	TFS3/4	0.030	0.76	TFT3/4	0.025	0.64	-	-	-	Random Length Coil		
7/8	0.885	22.22	TFS7/8	0.035	0.89	-	-	-	-	-	-	Random Length Coil		
1	1.010	25.40	TFS1.00	0.035	0.89	-	-	-	-	-	-	Random Length Coil		

For detailed ordering information, please consult price list or contact Parflex® Division.



PTFE Tubing

Series AWG: TFH, TFS, TFT, TFL



Features

- Virgin Polytetrafluoroethylene resin
- Chemically inert
- Lowest coefficient of friction
- Superior dielectric strength
- Exceptional heat resistance
- Self extinguishing
- Non-wetting
- Excellent flexlife
- Laser markable

Applications/Markets



- Electrical Insulation
- Protective Cover
- Circuit Board
- Wire Insulation
- Strain Relief
- Introducer
- Stent Delivery



Certifications/Compliance

- AMS 3653E
- VW1, UL-83 (natural)
- FDA Compliant
- USP Class VI Compliant
- **Light Wall** (TFL) – ASTM D3295 Class 1, AMS 3654C, UL-224 150V 200°C
- **Thin Wall** (TFT) – ASTM D3295 Class 2, AMS 3655B, UL-224 300V 200°C, CSA 9032-01 300V
- **Standard Wall** (TFS) – ASTM D3295 Class 3, MIL-I-22129C, UL-224 600V 200°C, CSA 9032-01 600V
- **Heavy Wall** (TFH) – ASTM D3295, Class 4

Order Information

Example: TFH13-2TC

TFH13-2TC – PTFE

TFH13-2TC – Heavy Wall

TFH13-2TC – AWG Size

TFH13-2TC – Red

TFH13-2TC – Bulk Tubing

TFH13-2TC – Solid Color Tube

Colors

- ○ Natural, Translucent
- Colors available as custom run, see color code table

Color Code					
○	N	Natural	●	5	Green
●	0	Black	●	6	Blue
●	1	Brown	●	7	Violet
●	2	Red	●	8	Gray
●	3	Orange	○	9	White
●	4	Yellow			

Notes

- Working Temperature: 500°F (260°C)
- AWG Spaghetti tubing is supplied in random lengths with a minimum length of 25 feet
- Continuous lengths and colors quoted upon request
- AWG spaghetti tubing is also available in FEP and PFA
- Consult factory for pricing and minimum lengths

TFH PTFE AWG Heavy Wall

Part Number	Order Size	Nominal I.D.		Minimum I.D.		Maximum I.D.		Nominal Wall		Standard Packaging
		inch	mm	inch	mm	inch	mm	inch	mm	
#										
	AWG	inch	mm	inch	mm	inch	mm	inch	mm	
TFH24	24	0.022	0.56	0.020	0.51	0.026	0.66	0.016 ± 0.003	0.41 ± 0.08	1,000 ft. Spool
TFH23	23	0.026	0.66	0.023	0.58	0.029	0.74	0.016 ± 0.003	0.41 ± 0.08	1,000 ft. Spool
TFH22	22	0.028	0.71	0.025	0.64	0.032	0.81	0.016 ± 0.003	0.41 ± 0.08	1,000 ft. Spool
TFH21	21	0.032	0.81	0.029	0.74	0.035	0.89	0.016 ± 0.003	0.41 ± 0.08	1,000 ft. Spool
TFH20	20	0.034	0.86	0.032	0.81	0.040	1.02	0.018 ± 0.003	0.46 ± 0.08	1,000 ft. Spool
TFH19	19	0.038	0.97	0.036	0.91	0.044	1.12	0.020 ± 0.004	0.51 ± 0.10	1,000 ft. Spool
TFH18	18	0.042	1.07	0.040	1.02	0.049	1.25	0.020 ± 0.004	0.51 ± 0.10	1,000 ft. Spool
TFH17	17	0.048	1.22	0.045	1.14	0.054	1.37	0.020 ± 0.004	0.51 ± 0.10	1,000 ft. Spool
TFH16	16	0.053	1.35	0.051	1.30	0.061	1.55	0.020 ± 0.004	0.51 ± 0.10	1,000 ft. Spool
TFH15	15	0.059	1.50	0.057	1.45	0.067	1.70	0.020 ± 0.004	0.51 ± 0.10	1,000 ft. Spool
TFH14	14	0.066	1.68	0.064	1.63	0.074	1.88	0.020 ± 0.004	0.51 ± 0.10	500 ft. Spool
TFH13	13	0.076	1.93	0.072	1.83	0.082	2.08	0.020 ± 0.004	0.51 ± 0.10	500 ft. Spool
TFH12	12	0.085	2.16	0.081	2.06	0.091	2.31	0.020 ± 0.004	0.51 ± 0.10	500 ft. Spool
TFH11	11	0.095	2.41	0.091	2.31	0.101	2.57	0.020 ± 0.004	0.51 ± 0.10	500 ft. Spool
TFH10	10	0.106	2.69	0.102	2.59	0.112	2.84	0.025 ± 0.005	0.64 ± 0.13	500 ft. Spool
TFH09	9	0.118	3.00	0.114	2.90	0.124	3.15	0.025 ± 0.005	0.64 ± 0.13	500 ft. Spool
TFH08	8	0.133	3.38	0.129	3.28	0.141	3.58	0.030 ± 0.005	0.76 ± 0.13	Random Length Coil
TFH07	7	0.148	3.76	0.144	3.66	0.158	4.01	0.030 ± 0.005	0.76 ± 0.13	Random Length Coil
TFH06	6	0.166	4.22	0.162	4.11	0.178	4.52	0.030 ± 0.005	0.76 ± 0.13	Random Length Coil
TFH05	5	0.185	4.70	0.182	4.62	0.196	4.98	0.032 ± 0.005	0.81 ± 0.13	Random Length Coil

Certifications

- ASTM D3295 Class 4
- AMS 3653E
- FDA Compliant
- USP Class VI Compliant

For detailed ordering information, please consult price list or contact Parflex® Division.

PTFE Tubing

Series AWG: TFH, TFL, TFS, TFT (cont.)

TFS PTFE AWG Standard Wall

Part Number	Order Size	Nominal I.D.		Minimum I.D.		Maximum I.D.		Nominal Wall		Standard Packaging
#										
	AWG	inch	mm	inch	mm	inch	mm	inch	mm	
TFS30	30	0.012	0.31	0.010	0.25	0.015	0.38	.009 ± .002	0.23 ± 0.51	1,000 ft. Spool
TFS28	28	0.015	0.38	0.013	0.33	0.018	0.46	.009 ± .002	0.23 ± 0.51	1,000 ft. Spool
TFS26	26	0.018	0.46	0.016	0.41	0.022	0.56	.009 ± .002	0.23 ± 0.51	1,000 ft. Spool
TFS24	24	0.022	0.56	0.020	0.51	0.026	0.66	.012 ± .003	0.31 ± 0.08	1,000 ft. Spool
TFS23	23	0.026	0.66	0.023	0.58	0.029	0.74	.012 ± .003	0.31 ± 0.08	1,000 ft. Spool
TFS22	22	0.028	0.71	0.025	0.64	0.032	0.81	.012 ± .003	0.31 ± 0.08	1,000 ft. Spool
TFS21	21	0.032	0.81	0.029	0.74	0.035	0.89	.012 ± .003	0.31 ± 0.08	1,000 ft. Spool
TFS20	20	0.034	0.86	0.032	0.81	0.040	1.02	.016 ± .003	0.41 ± .008	1,000 ft. Spool
TFS19	19	0.038	0.97	0.036	0.91	0.044	1.12	.016 ± .003	0.41 ± .008	1,000 ft. Spool
TFS18	18	0.042	1.07	0.040	1.02	0.049	1.25	.016 ± .003	0.41 ± .008	1,000 ft. Spool
TFS17	17	0.048	1.22	0.045	1.14	0.054	1.37	.016 ± .003	0.41 ± .008	1,000 ft. Spool
TFS16	16	0.053	1.35	0.051	1.30	0.061	1.55	.016 ± .003	0.41 ± .008	1,000 ft. Spool
TFS15	15	0.059	1.50	0.057	1.45	0.067	1.70	.016 ± .003	0.41 ± .008	500 ft. Spool
TFS14	14	0.066	1.68	0.064	1.63	0.074	1.88	.016 ± .003	0.41 ± .008	500 ft. Spool
TFS13	13	0.076	1.93	0.072	1.83	0.082	2.08	.016 ± .003	0.41 ± .008	500 ft. Spool
TFS12	12	0.085	2.16	0.081	2.06	0.091	2.31	.016 ± .003	0.41 ± .008	500 ft. Spool
TFS11	11	0.095	2.41	0.091	2.31	0.101	2.57	.016 ± .003	0.41 ± .008	500 ft. Spool
TFS10	10	0.106	2.69	0.102	2.59	0.112	2.84	.016 ± .003	0.41 ± .008	500 ft. Spool
TFS09	9	0.118	3.00	0.114	2.90	0.124	3.15	.020 ± .004	0.51 ± .010	Random Length Coil
TFS08	8	0.133	3.38	0.129	3.28	0.141	3.58	.020 ± .004	0.51 ± .010	Random Length Coil
TFS07	7	0.148	3.76	0.144	3.66	0.158	4.01	.020 ± .004	0.51 ± .010	Random Length Coil
TFS06	6	0.166	4.22	0.162	4.11	0.178	4.52	.020 ± .004	0.51 ± .010	Random Length Coil
TFS05	5	0.185	4.70	0.182	4.62	0.196	4.98	.020 ± .004	0.51 ± .010	Random Length Coil
TFS04	4	0.208	5.28	0.204	5.18	0.224	5.69	.020 ± .004	0.51 ± .010	Random Length Coil
TFS03	3	0.234	5.94	0.229	5.82	0.249	6.32	.020 ± .004	0.51 ± .010	Random Length Coil
TFS02	2	0.263	6.68	0.258	6.55	0.278	7.06	.020 ± .004	0.51 ± .010	Random Length Coil
TFS01	1	0.294	7.47	0.289	7.34	0.311	7.90	.020 ± .004	0.51 ± .010	Random Length Coil
TFS00	0	0.330	8.38	0.325	8.25	0.347	8.81	.020 ± .004	0.51 ± .010	Random Length Coil

Certifications

- ASTM D3295 Class 3
- MIL-I-22129C
- AMS 3653E
- UL-224 600V 200°C
- CSA 9032-01 600V
- FDA Compliant



For detailed ordering information, please consult price list or contact Parflex® Division.

TFT PTFE AWG Thin Wall

Part Number	Order Size	Nominal I.D.		Minimum I.D.		Maximum I.D.		Nominal Wall		Standard Packaging
		inch	mm	inch	mm	inch	mm	inch	mm	
#										
	AWG	inch	mm	inch	mm	inch	mm	inch	mm	
TFT32	32	.010	0.25	.008	0.20	.012	0.31	0.007 ± 0.002	0.18 ± 0.05	1,000 ft. Spool Only
TFT30	30	.012	0.31	.010	0.25	.015	0.38	0.009 ± 0.002	0.23 ± 0.05	1,000 ft. Spool
TFT28	28	.015	0.38	.013	0.33	.018	0.46	0.009 ± 0.002	0.23 ± 0.05	1,000 ft. Spool
TFT26	26	.018	0.46	.016	0.41	.022	0.56	0.009 ± 0.002	0.23 ± 0.05	1,000 ft. Spool
TFT24	24	.022	0.56	.020	0.51	.026	0.66	0.010 ± 0.003	0.25 ± 0.08	1,000 ft. Spool
TFT23	23	.026	0.66	.023	0.58	.029	0.74	0.010 ± 0.003	0.25 ± 0.08	1,000 ft. Spool
TFT22	22	.028	0.71	.025	0.64	.032	0.81	0.010 ± 0.003	0.25 ± 0.08	1,000 ft. Spool
TFT21	21	.032	0.81	.029	0.74	.035	0.89	0.010 ± 0.003	0.25 ± 0.08	1,000 ft. Spool
TFT20	20	.034	0.86	.032	0.81	.040	1.02	0.012 ± 0.003	0.31 ± 0.08	1,000 ft. Spool
TFT19	19	.038	0.97	.036	0.91	.044	1.12	0.012 ± 0.003	0.31 ± 0.08	1,000 ft. Spool
TFT18	18	.042	1.07	.040	1.02	.049	1.25	0.012 ± 0.003	0.31 ± 0.08	1,000 ft. Spool
TFT17	17	.048	1.22	.045	1.14	.054	1.37	0.012 ± 0.003	0.31 ± 0.08	1,000 ft. Spool
TFT16	16	.053	1.35	.051	1.30	.061	1.55	0.012 ± 0.003	0.31 ± 0.08	1,000 ft. Spool
TFT15	15	.059	1.50	.057	1.45	.067	1.70	0.012 ± 0.003	0.31 ± 0.08	1,000 ft. Spool
TFT14	14	.066	1.68	.064	1.63	.074	1.88	0.012 ± 0.003	0.31 ± 0.08	500 ft. Spool
TFT13	13	.076	1.93	.072	1.83	.082	2.08	0.012 ± 0.003	0.31 ± 0.08	500 ft. Spool
TFT12	12	.085	2.16	.081	2.06	.091	2.31	0.012 ± 0.003	0.31 ± 0.08	500 ft. Spool
TFT11	11	.095	2.41	.091	2.31	.101	2.57	0.012 ± 0.003	0.31 ± 0.08	500 ft. Spool
TFT10	10	.106	2.69	.102	2.59	.112	2.84	0.012 ± 0.003	0.31 ± 0.08	500 ft. Spool
TFT09	9	.118	3.00	.114	2.90	.124	3.15	0.015 ± 0.003	0.38 ± 0.08	500 ft. Spool
TFT08	8	.133	3.38	.129	3.28	.141	3.58	0.015 ± 0.003	0.38 ± 0.08	Random Length Coil
TFT07	7	.148	3.76	.144	3.66	.158	4.01	0.015 ± 0.003	0.38 ± 0.08	Random Length Coil
TFT06	6	.166	4.22	.162	4.11	.178	4.52	0.015 ± 0.003	0.38 ± 0.08	Random Length Coil
TFT05	5	.185	4.70	.182	4.62	.196	4.98	0.015 ± 0.003	0.38 ± 0.08	Random Length Coil
TFT04	4	.208	5.28	.204	5.18	.224	5.69	0.015 ± 0.003	0.38 ± 0.08	Random Length Coil
TFT03	3	.234	5.94	.229	5.82	.249	6.32	0.015 ± 0.003	0.38 ± 0.08	Random Length Coil
TFT02	2	.263	6.68	.258	6.55	.278	7.06	0.015 ± 0.003	0.38 ± 0.08	Random Length Coil
TFT01	1	.294	7.47	.289	7.34	.311	7.90	0.015 ± 0.003	0.38 ± 0.08	Random Length Coil
TFT00	0	.330	8.38	.325	8.25	.347	8.81	0.015 ± 0.003	0.38 ± 0.08	Random Length Coil

Certifications

- ASTM D3295 Class 2
- AMS 3653E
- AMS 3655B
- UL-224 300V 200°C
- CSA 9032-01 300V
- FDA Compliant
- USP Class VI Compliant

For detailed ordering information, please consult price list or contact Parflex® Division.

PTFE Tubing

Series AWG: TFH, TFL, TFS, TFT (cont.)

TFL PTFE AWG Light Wall

Part Number	Order Size	Nominal I.D.		Minimum I.D.		Maximum I.D.		Nominal Wall		Standard Packaging
#										
	AWG	inch	mm	inch	mm	inch	mm	inch	mm	
TFL32	32	0.010	0.25	0.008	0.20	0.012	0.31	0.005 ± 0.002	0.13 ± 0.05	1,000 ft. Spool Only
TFL30	30	0.012	0.31	0.010	0.25	0.015	0.38	0.006 ± 0.002	0.13 ± 0.05	1,000 ft. Spool
TFL28	28	0.015	0.38	0.013	0.33	0.018	0.46	0.006 ± 0.002	0.13 ± 0.05	1,000 ft. Spool
TFL26	26	0.018	0.46	0.016	0.41	0.022	0.56	0.006 ± 0.002	0.13 ± 0.05	1,000 ft. Spool
TFL24	24	0.022	0.56	0.020	0.51	0.026	0.66	0.006 ± 0.002	0.13 ± 0.05	1,000 ft. Spool
TFL23	23	0.026	0.66	0.023	0.58	0.029	0.74	0.006 ± 0.002	0.13 ± 0.05	1,000 ft. Spool
TFL22	22	0.028	0.71	0.025	0.64	0.032	0.81	0.006 ± 0.002	0.13 ± 0.05	1,000 ft. Spool
TFL21	21	0.032	0.81	0.029	0.74	0.035	0.89	0.006 ± 0.002	0.13 ± 0.05	1,000 ft. Spool
TFL20	20	0.034	0.86	0.032	0.81	0.040	1.02	0.006 ± 0.002	0.13 ± 0.05	1,000 ft. Spool
TFL19	19	0.038	0.97	0.036	0.91	0.044	1.12	0.006 ± 0.002	0.13 ± 0.05	1,000 ft. Spool
TFL18	18	0.042	1.07	0.040	1.02	0.049	1.25	0.006 ± 0.002	0.13 ± 0.05	1,000 ft. Spool
TFL17	17	0.048	1.22	0.045	1.14	0.054	1.37	0.006 ± 0.002	0.13 ± 0.05	1,000 ft. Spool
TFL16	16	0.053	1.35	0.051	1.30	0.061	1.55	0.006 ± 0.002	0.13 ± 0.05	1,000 ft. Spool
TFL15	15	0.059	1.50	0.057	1.45	0.067	1.70	0.006 ± 0.002	0.13 ± 0.05	1,000 ft. Spool
TFL14	14	0.066	1.68	0.064	1.63	0.074	1.88	0.008 ± 0.002	0.20 ± 0.05	500 ft. Spool
TFL13	13	0.076	1.93	0.072	1.83	0.082	2.08	0.008 ± 0.002	0.20 ± 0.05	500 ft. Spool
TFL12	12	0.085	2.16	0.081	2.06	0.091	2.31	0.008 ± 0.002	0.20 ± 0.05	500 ft. Spool
TFL11	11	0.095	2.41	0.091	2.31	0.101	2.57	0.008 ± 0.002	0.20 ± 0.05	500 ft. Spool
TFL10	10	0.106	2.69	0.102	2.59	0.112	2.84	0.008 ± 0.002	0.20 ± 0.05	500 ft. Spool
TFL09	9	0.118	3.00	0.114	2.90	0.124	3.15	0.008 ± 0.002	0.20 ± 0.05	500 ft. Spool
TFL08	8	0.133	3.38	0.129	3.28	0.141	3.58	0.008 ± 0.002	0.20 ± 0.05	Random Length Coil
TFL07	7	0.148	3.76	0.144	3.66	0.158	4.01	0.008 ± 0.002	0.20 ± 0.05	Random Length Coil
TFL06	6	0.166	4.22	0.162	4.11	0.178	4.52	0.010 ± 0.003	0.25 ± 0.08	Random Length Coil
TFL05	5	0.185	4.70	0.182	4.62	0.196	4.98	0.010 ± 0.003	0.25 ± 0.08	Random Length Coil
TFL04	4	0.208	5.28	0.204	5.18	0.224	5.69	0.010 ± 0.003	0.25 ± 0.08	Random Length Coil
TFL03	3	0.234	5.94	0.229	5.82	0.249	6.32	0.010 ± 0.003	0.25 ± 0.08	Random Length Coil
TFL02	2	0.263	6.68	0.258	6.55	0.278	7.06	0.010 ± 0.003	0.25 ± 0.08	Random Length Coil
TFL01	1	0.294	7.47	0.289	7.34	0.311	7.90	0.012 ± 0.003	0.31 ± 0.08	Random Length Coil
TFL00	0	0.330	8.38	0.325	8.25	0.347	8.81	0.012 ± 0.003	0.31 ± 0.08	Random Length Coil

Certifications

- ASTM D3295 Class 1
- AMS 3653E
- AMS 3654C
- UL-224 150V 200°C
- FDA Compliant
- USP Class VI Compliant



For detailed ordering information, please consult price list or contact Parflex® Division.

PTFE Beading

Series Fractional: TFB



Applications/Markets



- Pull Cord
- O-ring Seals
- Spacers
- Woven Filter

TFB PTFE Beading

Part Number	Diameter		Tolerance		Standard Packaging
	inch	mm	inch	mm	
#	⊙				
TFB015	0.015	0.38	± 0.002	± 0.05	1,000 ft. Spool
TFB020	0.020	0.51	± 0.002	± 0.05	1,000 ft. Spool
TFB025	0.025	0.64	± 0.002	± 0.05	1,000 ft. Spool
TFB028	0.028	0.71	± 0.002	± 0.05	1,000 ft. Spool
TFB031	0.031	0.79	± 0.002	± 0.05	1,000 ft. Spool
TFB035	0.035	0.89	± 0.002	± 0.05	1,000 ft. Spool
TFB039	0.039	0.99	± 0.002	± 0.05	1,000 ft. Spool
TFB043	0.043	1.09	± 0.002	± 0.05	1,000 ft. Spool
TFB047	0.047	1.19	± 0.002	± 0.05	1,000 ft. Spool
TFB050	0.050	1.27	± 0.002	± 0.05	1,000 ft. Spool
TFB055	0.055	1.40	± 0.003	± 0.08	1,000 ft. Spool
TFB060	0.060	1.52	± 0.003	± 0.08	1,000 ft. Spool
TFB062	0.062	1.57	± 0.003	± 0.08	1,000 ft. Spool
TFB070	0.070	1.78	± 0.003	± 0.08	1,000 ft. Spool
TFB072	0.072	1.83	± 0.003	± 0.08	1,000 ft. Spool
TFB078	0.078	1.98	± 0.004	± 0.10	500 ft. Spool
TFB080	0.080	2.03	± 0.004	± 0.10	500 ft. Spool
TFB084	0.084	2.13	± 0.004	± 0.10	500 ft. Spool
TFB090	0.090	2.29	± 0.004	± 0.10	500 ft. Spool
TFB094	0.094	2.39	± 0.004	± 0.10	500 ft. Spool
TFB100	0.100	2.54	± 0.004	± 0.10	500 ft. Spool
TFB109	0.109	2.77	± 0.004	± 0.10	500 ft. Spool
TFB115	0.115	2.92	± 0.004	± 0.10	500 ft. Spool
TFB125	0.125	3.18	± 0.004	± 0.10	Random Length
TFB150	0.150	3.81	± 0.004	± 0.10	Random Length
TFB188	0.188	4.78	± 0.004	± 0.10	Random Length

Features

- Virgin Polytetrafluoroethylene resin
- Chemically inert
- Lowest coefficient of friction
- Superior dielectric strength
- Exceptional heat resistance
- Self extinguishing
- Non-wetting
- Excellent flexlife
- Laser markable

Certifications

- ASTM D1710, Type 1, Grade 1, Class B
- ASTM D3295
- VW1, UL-83 (natural)
- FDA Compliant
- USP Class VI Compliant

Notes

- Working Temperature: -100°F to 500°F (-75°C to 260°C)
- Package quantities are not continuous

Colors

- ○ Natural, Translucent
- Colors available as custom run, see color code table

Color Code					
○	N	Natural	●	5	Green
●	0	Black	●	6	Blue
●	1	Brown	●	7	Violet
●	2	Red	●	8	Gray
●	3	Orange	○	9	White
●	4	Yellow			

Order Information

Example: TFB028-NT

TFB028-NT – PTFE Beading

TFB028-NT – Beading O.D. in inches (.028")

TFB028-NT – Natural

TFB028-NT – Bulk Tubing

For detailed ordering information, please consult price list or contact Parflex® Division.

PTFE Spiral Cut Cable Wrap

Series: TSWTF

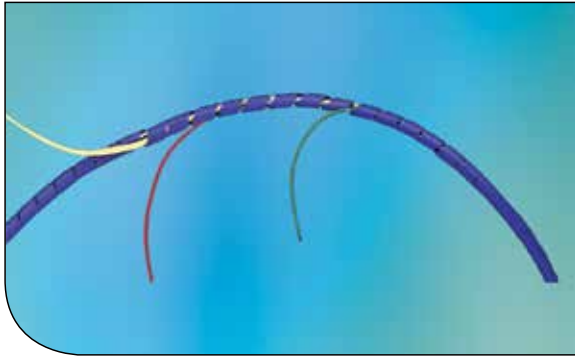

Features

- Provides harnessing for wires and cable while allowing leads at various points
- Exceptional heat resistance
- Self extinguishing
- Flexible
- Superior dielectric strength

Certifications

- A-A-59602
- AMS 3653E
- ASTM D3295
- VW1, UL-83 (natural)

Applications/Markets



- Cable harnessing
- Wiring closets
- Aerospace
- Automotive

Notes

- Available in left- or right-hand cut. Please specify with proper suffix at end of part number (i.e. TSWTF-18-NT-R)
- Working Temperature: 500°F (260°C)
- 100 ft. is the minimum item quantity sold
- Stock packaging for sizes 1/8" to 1/2" is 100- and 500-ft. non-continuous spools and, for sizes greater than 1/2", 100-ft. non-continuous spools
- Custom packaging, sizes and colors are available upon request
- Spiral cut cable wrap is also quoted in FEP upon request
- Package quantities are not continuous
- Colors available as custom run, see color code table

Colors

- ○ Natural, Translucent
- Colors available as custom run, see color code table

Color Code						
○	N	Natural	●	5	Green	
●	0	Black	●	6	Blue	
●	1	Brown	●	7	Violet	
●	2	Red	●	8	Gray	
●	3	Orange	○	9	White	
●	4	Yellow				

Order Information

Example: TSWTF-3/8-5T

TSWTF-3/8-5T – Spiral Wrap

TSWTF-3/8-5T – Material (PTFE)

TSWTF-3/8-5T – O.D. in inches (.375")

TSWTF-3/8-5T – Green

TSWTF-3/8-5T – Bulk Tubing

PTFE Spiral Wrap

Part Number	O.D. "A"		tolerance O.D.		Wall "B"		tolerance Wall		Pitch "D"		tolerance Pitch		Max Bundle O.D. "C"	
	inch	mm	inch	mm	inch	mm	inch	mm	inch	mm	inch	mm	inch	mm
#														
TSWTF-1/8-NT	0.125	3.18	± 0.005	0.127	0.020	0.508	± 0.008	0.203	0.212	5.38	± 0.015	0.381	1/2	12.70
TSWTF-3/16-NT	0.188	4.78	± 0.005	0.127	0.030	0.762	± 0.008	0.203	0.312	7.92	± 0.015	0.381	1	25.40
TSWTF-1/4-NT	0.250	6.35	± 0.005	0.127	0.030	0.762	± 0.008	0.203	0.375	9.52	± 0.015	0.381	2	50.80
TSWTF-3/8-NT	0.375	9.52	± 0.005	0.127	0.030	0.762	± 0.008	0.203	0.437	11.10	± 0.015	0.381	2-1/2	63.50
TSWTF-1/2-NT	0.500	12.70	± 0.005	0.127	0.030	0.762	± 0.008	0.203	0.562	14.27	± 0.015	0.381	3	76.20
TSWTF-3/4-NT	0.750	19.05	± 0.005	0.127	0.040	1.02	± 0.008	0.203	0.875	22.22	± 0.015	0.381	4	101.60
TSWTF-1.00-NT	1	25.40	± 0.005	0.127	0.040	1.02	± 0.008	0.203	1	25.40	± 0.015	0.381	6	152.40

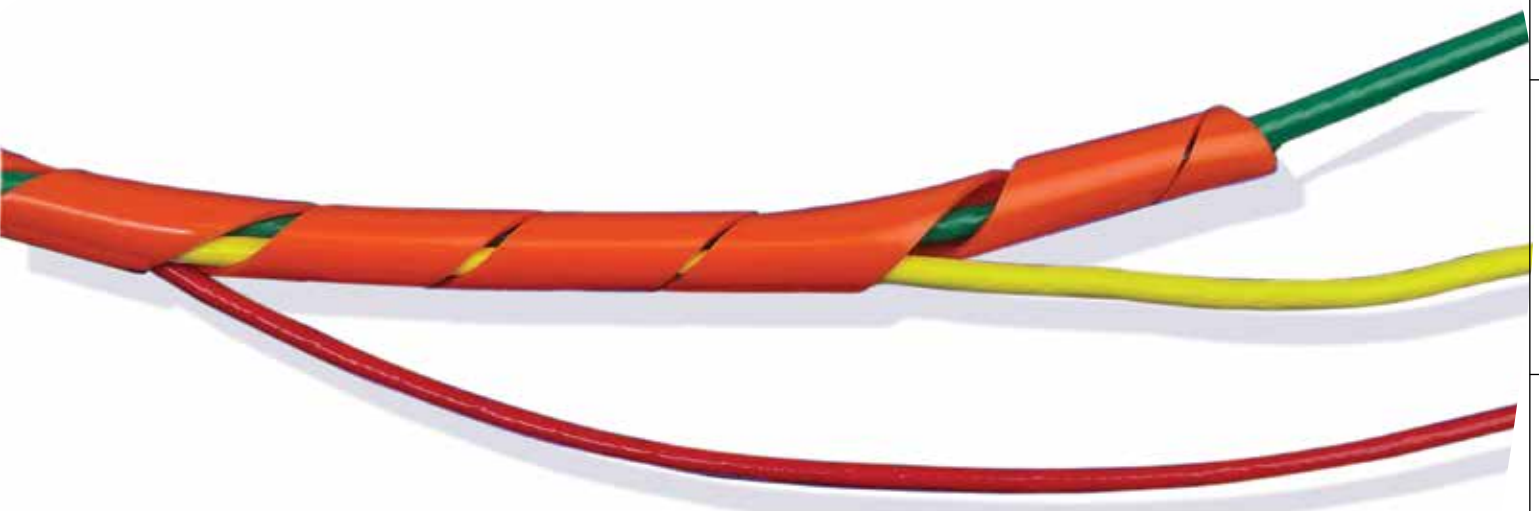
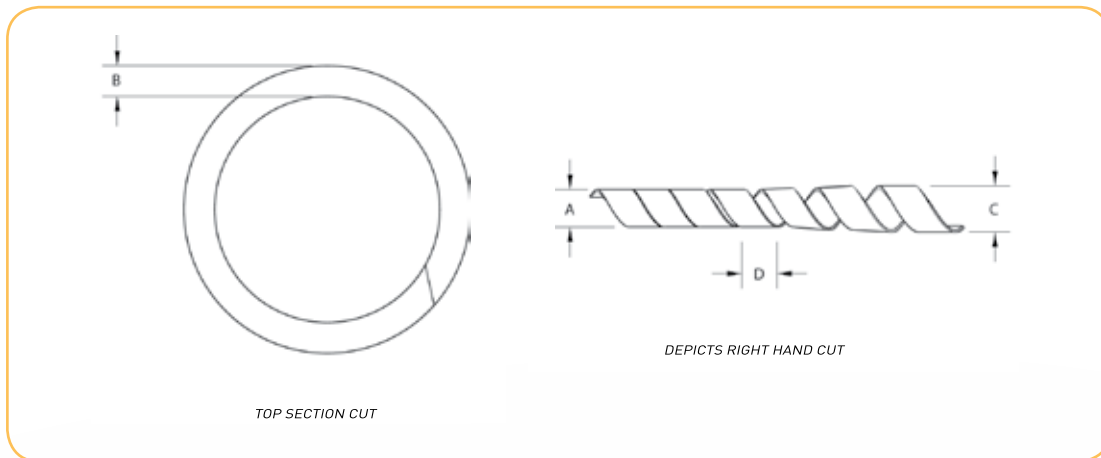

For detailed ordering information, please consult price list or contact Parflex® Division.

PTFE Heat Shrinkable Tubing

Series 2:1 Fractional: HS2TFS, HS2TFT, HS2TFL, HS2TFI



Features

- Virgin Polytetrafluoroethylene resin
- 2:1 Shrink Ratio
- Chemically inert
- Lowest coefficient of friction
- Superior dielectric strength
- Exceptional heat resistance
- Self extinguishing
- Non-wetting

Certifications

- ASTM D2902 Type I
- AMS 3653E
- VW1, UL-83 (natural)
- FDA Compliant
- USP Class VI Compliant
- **Light Wall** (HS2TFL) - AMS-DTL-23053/12A Class 4
- **Thin Wall** (HS2TFT) - AMS-DTL-23053/12A Class 3, AMS 3585
- **Standard Wall** (HS2TFS) - AMS-DTL-23053/12A Class 2, AMS 3586
- **Heavy Wall** (HS2TFH) - AMS-DTL-23053/12A Class 1 (Custom Order only)

Applications/Markets



- Electrical Insulation
- Protective Cover
- Electronic Harness
- Laboratory

Order Information

Example: HS2TFI7/8-NT

HS2TFI7/8-NT – Heat Shrink

HS2TFI7/8-NT – Shrink Ratio (2:1)

HS2TFI7/8-NT – PTFE

HS2TFI7/8-NT – Wall Type (Industrial Wall)

HS2TFI7/8-NT – Heat Shrink Size in inches (7/8")

HS2TFI7/8-NT – Natural

HS2TFI7/8-NT – Bulk Tubing

Notes

- Working Temperature: -100°F to 500°F (-75°C to 260°C)
- Shrink Temperature: 662°F (350°C) for 10 minutes per AMS-DTL-23053/12A
- *Dielectric Strength: $\geq 1,400$ V/M, per ASTM D 149 short term test of 10 MIL thickness (Volts/MIL)
- PTFE Fractional Heat Shrink tubing is available in stock packaging of 4-ft. straight lengths
- Minimum quantities may apply
- Custom packaging, sizes, lengths and colors are quoted upon request

Colors

- ○ Natural, Opaque to translucent
- Colors available as custom run, see color code table

When ordering coiled tubing in colors, the color code is always followed by TC; when ordering cut lengths, the color code is followed by CC

ie HS2TFI7/8-2TC ie HS2TFI7/8-0CC48.000

Color Code					
○	N	Natural	●	5	Green
●	0	Black	●	6	Blue
●	1	Brown	●	7	Violet
●	2	Red	●	8	Gray
●	3	Orange	○	9	White
●	4	Yellow			

HS2TFS & HS2TFT PTFE Fractional Heat Shrink Tubing (2:1) SW & TW

Order Size	Minimum Expanded I.D.		Maximum Recovered I.D.		Standard Wall				Thin Wall			
					Mil Spec*	Part Number	Nominal Recovered Wall		Mil Spec*	Part Number	Nominal Recovered Wall	
	inch	mm	inch	mm			inch	mm				
1/8	0.215	05.5	0.130	3.3	23053/12A-215	HS2TFS1/8	0.020 ± 0.004	0.51 ± 0.10	23053/12A-319	HS2TFT1/8	0.015 ± 0.003	0.38 ± 0.08
1/4	0.410	10.4	0.260	6.6	23053/12A-222	HS2TFS1/4	0.020 ± 0.004	0.51 ± 0.10	23053/12A-326	HS2TFT1/4	0.015 ± 0.004	0.38 ± 0.10
5/16	0.470	11.9	0.329	8.4	23053/12A-225	HS2TFS5/16	0.020 ± 0.004	0.51 ± 0.10	23053/12A-329	HS2TFT5/16	0.015 ± 0.004	0.38 ± 0.10
3/8	0.560	14.2	0.399	10.1	23053/12A-228	HS2TFS3/8	0.025 ± 0.006	0.64 ± 0.15	-	HS2TF 3/8	0.015 ± 0.004	0.38 ± 0.10
7/16	0.655	16.6	0.462	11.7	23053/12A-229	HS2TFS7/16	0.025 ± 0.006	0.64 ± 0.15	-	HS2TFT7/16	0.018 ± 0.004	0.46 ± 0.10
1/2	0.750	19.1	0.524	13.3	23053/12A-230	HS2TFS1/2	0.025 ± 0.006	0.64 ± 0.15	-	HS2TFT1/2	0.018 ± 0.004	0.46 ± 0.10
5/8	0.930	23.6	0.655	16.6	23053/12A-231	HS2TFS5/8	0.030 ± 0.006	0.76 ± 0.15	-	HS2TF 5/8	0.020 ± 0.004	0.51 ± 0.10
3/4	1.125	28.6	0.786	20.0	23053/12A-232	HS2TFS3/4	0.035 ± 0.008	0.89 ± 0.20	-	HS2TFT3/4	0.025 ± 0.004	0.64 ± 0.10
7/8	1.310	28.7	0.911	23.1	23053/12A-233	HS2TFS7/8	0.035 ± 0.008	0.89 ± 0.20	-	HS2TFT7/8	0.025 ± 0.004	0.64 ± 0.10
1	1.500	38.1	1.036	26.3	23053/12A-234	HS2TFS1.00	0.035 ± 0.008	0.89 ± 0.20	-	HS2TFT1.00	0.025 ± 0.004	0.64 ± 0.10

HS2TFL PTFE Fractional Heat Shrink Tubing (2:1) LW

Order Size	Minimum Expanded I.D.		Maximum Recovered I.D.		Light Wall			
					Mil Spec*	Part Number	Nominal Recovered Wall	
	inch	mm	inch	mm				
1/8	0.215	5.5	0.130	3.3	23053/12A-415	HS2TFL1/8	0.008 ± 0.002	0.20 ± 0.05
1/4	0.410	10.4	0.260	6.6	23053/12A-422	HS2TFL1/4	0.010 ± 0.003	0.25 ± 0.08
5/16	0.470	11.9	0.329	8.4	23053/12A-425	HS2TFL5/16	0.012 ± 0.003	0.31 ± 0.08

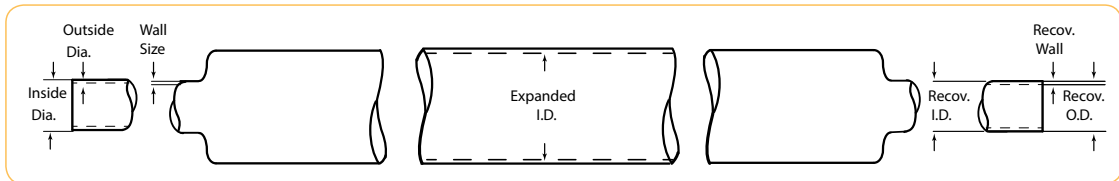

HS2TFI PTFE Fractional Heat Shrink Tubing (2:1), Ind. Heavy Wall

Part Number	Order Size	Mil Spec*	Minimum Expanded I.D.		Maximum Recovered I.D.		Nominal Recovered Wall	
			inch	mm	inch	mm	inch	mm
HS2TFI1/8	1/8	23053/12A-101	0.166	4.2	0.130	3.3	0.030 ± 0.005	0.76 ± 0.13
HS2TFI3/16	3/16	23053/12A-102	0.250	6.4	0.193	4.9	0.030 ± 0.005	0.76 ± 0.13
HS2TFI1/4	1/4	23053/12A-103	0.333	8.4	0.257	6.5	0.030 ± 0.005	0.76 ± 0.13
HS2TFI5/16	5/16	23053/12A-104	0.415	10.5	0.320	8.1	0.030 ± 0.005	0.76 ± 0.13
HS2TFI3/8	3/8	23053/12A-105	0.498	12.6	0.383	9.7	0.030 ± 0.005	0.76 ± 0.13
HS2TFI7/16	7/16	23053/12A-106	0.580	14.7	0.448	11.4	0.030 ± 0.006	0.76 ± 0.15
HS2TFI1/2	1/2	23053/12A-107	0.666	16.9	0.510	13.0	0.030 ± 0.006	0.76 ± 0.15
HS2TFI9/16	9/16	23053/12A-108	0.748	19.0	0.572	14.5	0.030 ± 0.006	0.76 ± 0.15
HS2TFI5/8	5/8	23053/12A-109	0.830	21.1	0.637	16.2	0.030 ± 0.006	0.76 ± 0.15
HS2TFI11/16	11/16	23053/12A-110	0.915	23.2	0.700	17.8	0.032 ± 0.006	0.81 ± 0.15
HS2TFI3/4	3/4	23053/12A-111	1.000	25.4	0.764	19.4	0.040 ± 0.007	1.02 ± 0.18
HS2TFI7/8	7/8	23053/12A-112	1.170	29.7	0.891	22.6	0.045 ± 0.007	1.14 ± 0.18
HS2TFI1.00	1	23053/12A-113	1.330	33.8	1.020	25.9	0.050 ± 0.008	1.27 ± 0.20

For detailed ordering information, please consult price list or contact Parflex® Division.



PTFE Heat Shrinkable Tubing

Series 2:1 AWG: HS2TFS, HS2TFT, HS2TFL



Applications/Markets



- Electrical Insulation
- Protective Cover
- Electronic Harness
- Laboratory

Features

- Virgin Polytetrafluoroethylene resin
- 2:1 Shrink Ratio
- Chemically inert
- Lowest coefficient of friction
- Superior dielectric strength
- Exceptional heat resistance
- Self extinguishing
- Non-wetting

Certifications

- ASTM D2902 Type I
- AMS 3653E
- VW1, UL-83 (natural)
- FDA Compliant
- USP Class VI Compliant
- **Light Wall** (HS2TFL) – AMS-DTL-23053/12A Class 4
- **Thin Wall** (HS2TFT) – AMS-DTL-23053/12A Class 3, AMS 3585
- **Standard Wall** (HS2TFS) – AMS-DTL-23053/12A Class 2, AMS 3586
- **Heavy Wall** (HS2TFH) – AMS-DTL-23053/12A Class 1 (Custom Order only)

Order Information

Example: HS2TFS15-4TC-500

HS2TFS15-4TC-500 – Heat Shrink

HS2TFS15-4TC-500 – Shrink Ratio (2:1)

HS2TFS15-4TC-500 – PTFE

HS2TFS15-4TC-500 – Wall Type (Standard Wall)

HS2TFS15-4TC-500 – Heat Shrink Size in AWG (AWG15)

HS2TFS15-4TC-500 – Yellow

HS2TFS15-4TC-500 – Bulk Tubing

HS2TFS15-4TC-500 – Solid Color

HS2TFS15-4TC-500 – Package Quantity in feet (500')

Notes

- Working Temperature: -100°F to 500°F (-75°C to 260°C)
- Shrink Temperature: 662°F (350°C) for 10 minutes AMS-DTL-23053/12A
- *Dielectric Strength: $\geq 1,400$ V/M, per ASTM D 149 short term test of 10 MIL thickness (Volts/MIL)
- PTFE AWG Heat Shrink tubing is available in stock packaging of 4-ft. straight lengths
- Minimum quantities may apply
- Custom packaging, sizes, lengths and colors are quoted upon request

Colors

- ○ Natural, Opaque to translucent
- Colors available as custom run, see color code table

When ordering coiled tubing in colors, the color code is always followed by TC; when ordering cut lengths, the color code is followed by CC

ie HS2TFS15-2TC ie HS2TFS15-0CC48.000

Color Code					
○	N	Natural	●	5	Green
●	0	Black	●	6	Blue
●	1	Brown	●	7	Violet
●	2	Red	●	8	Gray
●	3	Orange	○	9	White
●	4	Yellow			

HS2TFS Standard Wall (2:1)

Part Number	Order Size AWG	Mil Spec*	Minimum Expanded I.D.		Maximum Recovered I.D.		Nominal Recovered Wall	
			inch	mm	inch	mm	inch	mm
HS2TFS24	24	23053/12A-201	0.050	1.27	0.027	0.69	0.012 ± 0.002	0.31 ± 0.05
HS2TFS22	22	23053/12A-202	0.055	1.40	0.032	0.81	0.012 ± 0.002	0.31 ± 0.05
HS2TFS20	20	23053/12A-203	0.060	1.52	0.039	0.99	0.016 ± 0.003	0.41 ± 0.08
HS2TFS19	19	23053/12A-204	0.065	1.65	0.043	1.09	0.016 ± 0.003	0.41 ± 0.08
HS2TFS18	18	23053/12A-205	0.076	1.93	0.049	1.25	0.016 ± 0.003	0.41 ± 0.08
HS2TFS17	17	23053/12A-206	0.085	2.16	0.054	1.37	0.016 ± 0.003	0.41 ± 0.08
HS2TFS16	16	-	0.093	2.36	0.061	1.55	0.016 ± 0.003	0.41 ± 0.08
HS2TFS15	15	23053/12A-207	0.110	2.79	0.067	1.70	0.016 ± 0.003	0.41 ± 0.08
HS2TFS14	14	23053/12A-208	0.120	3.05	0.072	1.83	0.016 ± 0.003	0.41 ± 0.08
HS2TFS13	13	23053/12A-210	0.140	3.56	0.080	2.03	0.016 ± 0.003	0.41 ± 0.08
HS2TFS12	12	23053/12A-211	0.150	3.81	0.089	2.26	0.016 ± 0.003	0.41 ± 0.08
HS2TFS11	11	23053/12A-212	0.170	4.32	0.101	2.57	0.016 ± 0.003	0.41 ± 0.08
HS2TFS10	10	23053/12A-213	0.191	4.85	0.112	2.84	0.016 ± 0.003	0.41 ± 0.08
HS2TFS09	9	23053/12A-214	0.205	5.21	0.124	3.15	0.020 ± 0.004	0.51 ± 0.10
HS2TFS08	8	23053/12A-216	0.240	6.10	0.141	3.58	0.020 ± 0.004	0.51 ± 0.10
HS2TFS07	7	23053/12A-217	0.270	6.86	0.158	4.01	0.020 ± 0.004	0.51 ± 0.10
HS2TFS06	6	23053/12A-218	0.302	7.67	0.178	4.52	0.020 ± 0.004	0.51 ± 0.10
HS2TFS05	5	23053/12A-219	0.320	8.13	0.198	5.03	0.020 ± 0.004	0.51 ± 0.10
HS2TFS04	4	23053/12A-220	0.370	9.40	0.224	5.69	0.020 ± 0.004	0.51 ± 0.10
HS2TFS03	3	23053/12A-221	0.390	9.91	0.249	6.32	0.020 ± 0.004	0.51 ± 0.10
HS2TFS02	2	23053/12A-223	0.430	10.9	0.278	7.06	0.020 ± 0.004	0.51 ± 0.10
HS2TFS01	1	23053/12A-224	0.450	11.4	0.311	7.90	0.020 ± 0.004	0.51 ± 0.10
HS2TFS00	0	23053/12A-226	0.470	11.9	0.347	8.81	0.020 ± 0.004	0.51 ± 0.10

Certifications

- AMS-DTL-23053/12A, Class 3
- AMS 3585
- ASTM D2902 Type I
- FDA Compliant
- USP Class VI Compliant

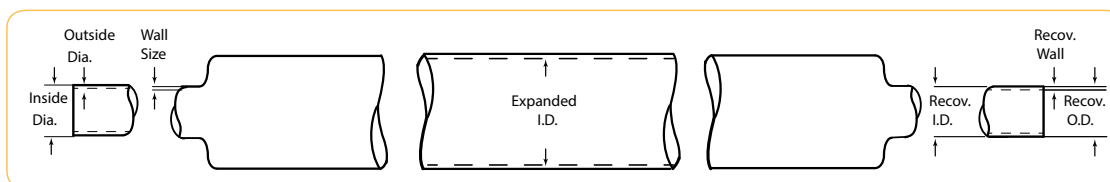

For detailed ordering information, please consult price list or contact Parflex® Division.

PTFE Heat Shrinkable Tubing

Series 2:1 AWG: HS2TFS, HS2TFT, HS2TFL (cont.)

HS2TFT Thin Wall (2:1)

Part Number	Order Size AWG	Mil Spec*	Minimum Expanded I.D.		Maximum Recovered I.D.		Nominal Recovered Wall	
			inch	mm	inch	mm	inch	mm
HS2TFT30	30	23053/12A-301	0.034	0.86	0.015	0.38	0.009 ± 0.002	0.23 ± 0.05
HS2TFT28	28	23053/12A-302	0.038	0.97	0.018	0.46	0.009 ± 0.002	0.23 ± 0.05
HS2TFT26	26	23053/12A-303	0.046	1.16	0.022	0.56	0.010 ± 0.003	0.25 ± 0.08
HS2TFT24	24	23053/12A-304	0.050	1.27	0.027	0.69	0.010 ± 0.002	0.25 ± 0.08
HS2TFT22	22	23053/12A-305	0.055	1.40	0.032	0.81	0.012 ± 0.003	0.31 ± 0.08
HS2TFT20	20	23053/12A-306	0.060	1.52	0.039	0.99	0.012 ± 0.003	0.31 ± 0.08
HS2TFT19	19	23053/12A-307	0.065	1.65	0.043	1.09	0.012 ± 0.003	0.31 ± 0.08
HS2TFT18	18	23053/12A-308	0.076	1.93	0.049	1.25	0.012 ± 0.003	0.31 ± 0.08
HS2TFT17	17	23053/12A-309	0.085	2.16	0.054	1.37	0.012 ± 0.003	0.31 ± 0.08
HS2TFT16	16	23053/12A-310	0.093	2.36	0.061	1.55	0.012 ± 0.003	0.31 ± 0.08
HS2TFT15	15	23053/12A-311	0.110	2.79	0.067	1.70	0.012 ± 0.003	0.31 ± 0.08
HS2TFT14	14	23053/12A-312	0.120	3.05	0.072	1.83	0.012 ± 0.003	0.31 ± 0.08
HS2TFT13	13	23053/12A-313	0.140	3.56	0.080	2.03	0.012 ± 0.003	0.31 ± 0.08
HS2TFT12	12	23053/12A-314	0.150	3.81	0.089	2.26	0.012 ± 0.003	0.31 ± 0.08
HS2TFT11	11	23053/12A-316	0.170	4.32	0.101	2.57	0.012 ± 0.003	0.31 ± 0.08
HS2TFT10	10	23053/12A-317	0.191	4.85	0.112	2.84	0.012 ± 0.003	0.31 ± 0.08
HS2TFT09	9	23053/12A-318	0.205	5.21	0.124	3.15	0.015 ± 0.004	0.38 ± 0.10
HS2TFT08	8	23053/12A-320	0.240	6.10	0.141	3.58	0.015 ± 0.004	0.38 ± 0.10
HS2TFT07	7	23053/12A-321	0.270	6.86	0.158	4.01	0.015 ± 0.004	0.38 ± 0.10
HS2TFT06	6	23053/12A-322	0.302	7.67	0.178	4.52	0.015 ± 0.004	0.38 ± 0.10
HS2TFT05	5	23053/12A-323	0.320	8.13	0.198	5.03	0.015 ± 0.004	0.38 ± 0.10
HS2TFT04	4	23053/12A-324	0.370	9.40	0.224	5.69	0.015 ± 0.004	0.38 ± 0.10
HS2TFT03	3	23053/12A-325	0.390	9.91	0.249	6.32	0.015 ± 0.004	0.38 ± 0.10
HS2TFT02	2	23053/12A-327	0.430	10.9	0.278	7.06	0.015 ± 0.004	0.38 ± 0.10
HS2TFT01	1	23053/12A-328	0.450	11.4	0.311	7.90	0.015 ± 0.004	0.38 ± 0.10
HS2TFT00	0	23053/12A-330	0.470	11.9	0.347	8.81	0.015 ± 0.004	0.38 ± 0.10

*Dielectric Strength: ≥ 1,400 V/M, per ASTM D 149 short term test of 10 MIL thickness (Volts/MIL)

Certifications

- AMS-DTL-23053/12A, Class 3
- AMS 3585
- ASTM D2902 Type I
- FDA Compliant
- USP Class VI Compliant

HS2TFL Light Wall (2:1)

Part Number	Order Size AWG	Mil Spec*	Minimum Expanded I.D.		Maximum Recovered I.D.		Nominal Recovered Wall	
			inch	mm	inch	mm	inch	mm
HS2TFL24	24	23053/12A-404	0.050	1.27	0.025	0.64	0.006 ± 0.002	0.15 ± 0.05
HS2TFL22	22	23053/12A-405	0.055	1.40	0.031	0.79	0.006 ± 0.002	0.15 ± 0.05
HS2TFL20	20	23053/12A-406	0.060	1.52	0.038	0.97	0.006 ± 0.002	0.15 ± 0.05
HS2TFL19	19	23053/12A-407	0.065	1.65	0.043	1.09	0.006 ± 0.002	0.15 ± 0.05
HS2TFL18	18	23053/12A-408	0.076	1.93	0.046	1.17	0.006 ± 0.002	0.15 ± 0.05
HS2TFL17	17	23053/12A-409	0.085	2.16	0.054	1.37	0.006 ± 0.002	0.15 ± 0.05
HS2TFL16	16	23053/12A-410	0.093	2.36	0.057	1.45	0.006 ± 0.002	0.15 ± 0.05
HS2TFL15	15	23053/12A-411	0.110	2.79	0.063	1.60	0.006 ± 0.002	0.15 ± 0.05
HS2TFL14	14	23053/12A-412	0.120	3.05	0.072	1.83	0.008 ± 0.002	0.20 ± 0.05
HS2TFL13	13	23053/12A-413	0.140	3.56	0.080	2.03	0.008 ± 0.002	0.20 ± 0.05
HS2TFL12	12	23053/12A-414	0.150	3.81	0.089	2.26	0.008 ± 0.002	0.20 ± 0.05
HS2TFL11	11	23053/12A-416	0.170	4.32	0.099	2.51	0.008 ± 0.002	0.20 ± 0.05
HS2TFL10	10	23053/12A-417	0.191	4.85	0.110	2.79	0.008 ± 0.002	0.20 ± 0.05
HS2TFL09	9	23053/12A-418	0.205	5.21	0.122	3.10	0.008 ± 0.002	0.20 ± 0.05
HS2TFL08	8	23053/12A-420	0.240	6.10	0.139	3.53	0.008 ± 0.002	0.20 ± 0.05
HS2TFL07	7	23053/12A-421	0.270	6.86	0.154	3.91	0.008 ± 0.002	0.20 ± 0.05
HS2TFL06	6	23053/12A-422	0.302	7.67	0.172	4.37	0.010 ± 0.003	0.25 ± 0.08
HS2TFL05	5	23053/12A-423	0.320	8.13	0.192	4.88	0.010 ± 0.003	0.25 ± 0.08
HS2TFL04	4	23053/12A-424	0.370	9.40	0.214	5.44	0.010 ± 0.003	0.25 ± 0.08
HS2TFL03	3	23053/12A-425	0.390	9.91	0.241	6.12	0.010 ± 0.003	0.25 ± 0.08
HS2TFL02	2	23053/12A-427	0.430	10.9	0.270	6.88	0.010 ± 0.003	0.25 ± 0.08
HS2TFL01	1	23053/12A-428	0.450	11.4	0.301	7.65	0.010 ± 0.003	0.25 ± 0.08
HS2TFL00	0	23053/12A-430	0.470	11.9	0.347	8.81	0.012 ± 0.003	0.31 ± 0.08

*Dielectric Strength: ≥ 1,400 V/M, per ASTM D 149 short term test of 10 MIL thickness (Volts/MIL)

Certifications

- AMS-DTL-23053/12A, Class 4
- ASTM D2902 Type I
- FDA Compliant
- USP Class VI Compliant

For detailed ordering information, please consult price list or contact Parflex® Division.

PTFE Heat Shrinkable Tubing

Series 4:1 HS4TFI



Applications/Markets



- Electrical Insulation
- Protective Cover
- Rollers
- Bulb Protection

Features

- Virgin Polytetrafluoroethylene resin
- 4:1 Shrink Ratio
- Chemically inert
- Lowest coefficient of friction
- Superior dielectric strength
- Exceptional heat resistance
- Self extinguishing
- Non-wetting

Certifications

- AMS-DTL-23053/12A, Class 5
- ASTM D2902 Type I
- AMS 3584A
- VWI, UL-83 (natural)
- FDA Compliant
- USP Class VI Compliant

Order Information

Example: HS4TFI5/8-NT

HS4TFI5/8-NT – Heat Shrink

HS4TFI5/8-NT – Shrink Ratio (4:1)

HS4TFI5/8-NT – PTFE

HS4TFI5/8-NT – Wall Type (Industrial Wall)

HS4TFI5/8-NT – Heat Shrink Size in inches (5/8")

HS4TFI5/8-NT – Natural

HS4TFI5/8-NT – Bulk Tubing

Notes

- Working Temperature: -500°F (260°C)
- Shrink Temperature: 662°F (350°C) for 10 minutes
AMS-DTL-23053/12A
- For full recovery, expanded diameter should be 50% larger than the diameter of the object to be recovered over
- *Dielectric Strength: $\geq 1,400$ V/M, per ASTM D 149 short term test of 10 MIL thickness (Volts/MIL)
- PTFE Fractional Heat Shrink tubing is available in stock packaging of 4-ft. straight lengths
- Minimum quantities may apply
- Custom packaging, sizes, lengths and colors are quoted upon request

Colors

- ○ Natural, Opaque to translucent
- Colors available as custom run, see color code table

When ordering coiled tubing in colors, the color code is always followed by TC; when ordering cut lengths, the color code is followed by CC

ie HS4TFI5/8-2TC ie HS4TFI5/8-0CC48.0000

Color Code					
○	N	Natural	●	5	Green
●	0	Black	●	6	Blue
●	1	Brown	●	7	Violet
●	2	Red	●	8	Gray
●	3	Orange	○	9	White
●	4	Yellow			

HS4TFI PTFE Industrial Wall Heat Shrink Tubing (4:1)

Part Number	Order Size inch	Mil Spec*	Minimum Expanded I.D.		Maximum Recovered I.D.		Nominal Recovered Wall	
			inch	mm	inch	mm	inch	mm
HS4TFI5/64	5/64	23053/12A-501	0.078	1.98	0.025	0.64	0.009 ± 0.002	0.23 ± 0.05
HS4TFI1/8	1/8	23053/12A-502	0.125	3.18	0.037	0.94	0.012 ± 0.002	0.31 ± 0.05
HS4TFI3/16	3/16	23053/12A-503	0.187	4.75	0.050	1.27	0.012 ± 0.002	0.31 ± 0.05
HS4TFI1/4	1/4	23053/12A-504	0.250	6.35	0.063	1.60	0.012 ± 0.002	0.31 ± 0.05
HS4TFI5/16	5/16	23053/12A-505	0.312	7.92	0.078	1.98	0.012 ± 0.002	0.31 ± 0.05
HS4TFI3/8	3/8	23053/12A-506	0.375	9.52	0.096	2.44	0.012 ± 0.002	0.31 ± 0.05
HS4TFI7/16	7/16	23053/12A-507	0.438	11.1	0.112	2.84	0.012 ± 0.002	0.31 ± 0.05
HS4TFI1/2	1/2	23053/12A-508	0.500	12.7	0.144	3.66	0.015 ± 0.004	0.38 ± 0.10
HS4TFI5/8	5/8	23053/12A-510	0.625	15.9	0.178	4.52	0.015 ± 0.004	0.38 ± 0.10
HS4TFI3/4	3/4	23053/12A-512	0.750	19.1	0.224	5.70	0.015 ± 0.004	0.38 ± 0.10
HS4TFI7/8	7/8	23053/12A-513	0.875	22.2	0.244	6.20	0.015 ± 0.004	0.38 ± 0.10
HS4TFI1.00	1	23053/12A-514	1.000	25.4	0.278	7.06	0.015 ± 0.004	0.38 ± 0.10
HS4TFI1.25	1-1/4	23053/12A-515	1.250	31.8	0.347	8.81	0.015 ± 0.004	0.38 ± 0.10

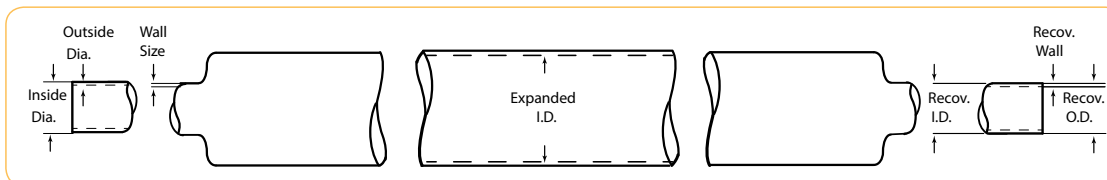

For detailed ordering information, please consult price list or contact Parflex® Division.

PTFE Convoluted

Series Convo-Tex®



Features

- Chemically inert
- Low coefficient of friction
- Very flexible
- Self extinguishing
- Non-wetting

Certifications

- AMS 3653E
- VW1, UL-83 (natural)
- FDA Compliant
- USP Class VI Compliant

Applications/Markets



- Fluid Transport
- Wire Harness
- Protection/Cable Core
- Robotics

Order Information

Example: CV01-1/8-NT

CV01-1/8-NT – Convoluted

CV01-1/8-NT – PTFE

CV01-1/8-NT – Size to Order (1/8")

CV01-1/8-NT – Color (N=Natural)

CV01-1/8-NT- "T" is bulk (for cuffed tubing, remove "T" and add length, ie. CV01-1/8-N1200 = 1" Convo, natural, cut 12" long)

Notes

- Working Temperature: -100°F to 500°F (-75°C to 260°C)
- Standard cuffs for Convo-Tex are sized on the Inside Diameter
- Wire wrap reinforcement can be added for increased pressure applications or when a tighter bend radius is needed
- Minimum quantities may apply
- Custom packaging, sizes, lengths and colors are quoted upon request

Colors

- ○ Natural, Opaque to Translucent
- Colors available as custom run, see color code table

Color Code					
○	N	Natural	●	5	Green
●	0	Black	●	6	Blue
●	1	Brown	●	7	Violet
●	2	Red	●	8	Gray
●	3	Orange	○	9	White
●	4	Yellow			

PTFE Convo-Tex® Convoluted

(Standard tubing is natural)

Part Number	Size To Order	Standard Cuff I.D. "A"		Standard Cuff Length "B"		Wall Thickness "C"		Min. Inside Diameter "D"		Max. Inside Diameter "D"		Max. Outside Diameter "E"		**Min. Bend Radius	
		inch	mm	inch	mm	inch	mm	inch	mm	inch	mm	inch	mm	inch	mm
CV01-1/8-NT	CONV-2	1/8	3.18	3/4	19.1	0.010	0.25	0.130	3.3	0.140	3.6	0.235	5.9	3/8	9.5
CV01-1/4-NT	CONV-4	1/4	6.35	3/4	19.1	0.015	0.38	0.181	4.6	0.188	4.8	0.320	8.1	1/2	12.7
CV01-5/16-NT	CONV-5	5/16	7.94	1	25.4	0.020	0.51	0.273	6.9	0.281	7.1	0.414	10.5	3/4	19.1
CV01-3/8-NT	CONV-6	3/8	9.53	1	25.4	0.020	0.51	0.303	7.7	0.312	7.9	0.450	11.4	1-3/4	44.4
CV01-1/2-NT	CONV-8	1/2	12.7	1	25.4	0.020	0.51	0.425	10.8	0.437	11.1	0.590	15.0	1-1/4	31.2
CV01-5/8-NT	CONV-10	5/8	15.9	1-1/4	31.8	0.025	0.64	0.485	12.3	0.500	12.7	0.660	16.8	1-1/2	38.1
CV01-3/4-NT	CONV-12	3/4	19.1	1-1/2	38.1	0.023	0.58	0.608	15.4	0.625	15.9	0.780	19.8	1-3/4	44.4
CV01-1.00-NT	CONV-16	1	25.4	2	50.8	0.030	0.76	0.849	21.6	0.875	22.2	1.100	27.9	2-1/4	57.2
CV01-1.25-NT	CONV-20	1-1/4	31.8	2-1/2	63.5	0.035	0.89	1.150	29.2	1.190	30.2	1.560	39.6	2-3/4	69.9
CV01-1.50-NT	CONV-24	1-1/2	38.1	2-1/2	63.5	0.040	1.02	1.410	35.8	1.490	37.8	1.910	48.5	3	76.2
CV01-2.00-NT	CONV-32	2	50.8	2-1/2	63.5	0.043	1.09	1.955	49.7	1.985	50.4	2.450	62.2	4-1/4	107.9
CV01-2.50-NT	CONV-40	2-1/2	63.5	2-1/2	63.5	0.062	1.57	2.460	62.5	2.540	64.5	3.210	81.6	5	127
CV01-3.00-NT	CONV-48	3	76.2	2-1/2	63.5	0.070	1.78	2.940	74.7	3.060	77.7	3.750	95.3	7	177.8
CV01-4.00-NT	CONV-64	4	101.6	2-1/2	63.5	0.070	1.78	3.940	100.1	4.060	103.1	4.750	120.6	9	228.6

** Minimum 36" length.

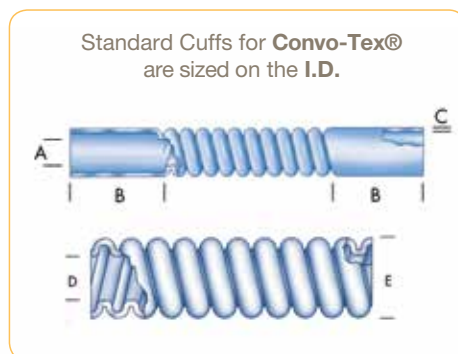

For detailed ordering information, please consult price list or contact Parflex® Division.

PTFE Convoluted

Series Low Profile and Heavy Wall

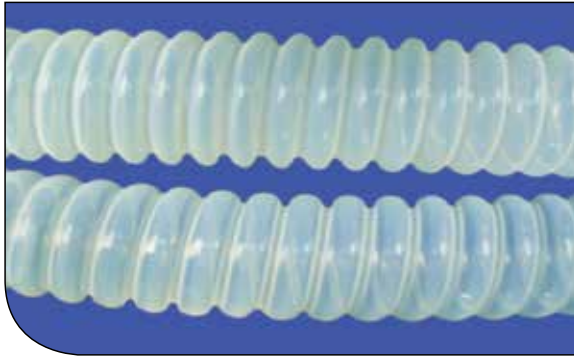

Applications/Markets



- Fluid Handling
- Harnesses
- Lab Equipment
- Robotics

Order Information

Example: CVH01-1/8-NT

CVH01-1/8-NT – CVH - Heavywall Convoluted
– CVL Low Profile Convoluted

CVH01-1/8-NT – **PTFE**

CVH01-**1/8**-NT – **Size to Order (1/8")**

CVH01-1/8-**NT** – **Color (N=Natural)**

CVH01-1/8-**NT**- "**T**" is **bulk** (for cuffed tubing, remove "**T**" and add length, ie. CVH01-1/8-N1200 = 1" Heavy Wall Convo, natural, cut 12" long)

Notes

- Working Temperature: 500°F (260°C)
- Standard cuffs for Convo-Tex are sized on the Inside Diameter
- Wire wrap reinforcement can be added for increased pressure applications or when a tighter bend radius is needed
- Minimum quantities may apply
- Custom packaging, sizes, lengths, cuffs and colors are quoted upon request

Features

- Chemically inert
- Low coefficient of friction
- Very flexible
- Self extinguishing
- Non-wetting

Low Profile

- Larger inside diameter
- Increased Flow

Heavy Wall

- Reinforces the strength of the tube allowing for braiding or covering, flanging or flaring
- Handles higher vacuum

Certifications

- AMS 3653E
- VW1, UL-83
- FDA Compliant
- USP Class VI Compliant

Colors

- ○ Natural, Opaque to Translucent
- Colors available as custom run, see color code table

Color Code					
○	N	Natural	●	5	Green
●	0	Black	●	6	Blue
●	1	Brown	●	7	Violet
●	2	Red	●	8	Gray
●	3	Orange	○	9	White
●	4	Yellow			

PTFE Low Profile Convoluted

(Standard tubing is natural)

Part Number	Size To Order	Min. Inside Diameter		Max. Inside Diameter		Max. Outside Diameter		Wall Thickness		**Min. Bend Radius	
		inch	mm	inch	mm	inch	mm	inch	mm	inch	mm
CVL01-3/8-NT	3/8	0.394	10.0	0.406	10.3	0.560	14.2	0.023	0.58	1/2	13
CVL01-1/2-NT	1/2	0.490	12.5	0.510	13.0	0.700	17.8	0.025	0.64	3/4	19
CVL01-3/4-NT	3/4	0.740	18.8	0.760	19.3	0.980	24.9	0.035	0.89	1.88	48
CVL01-1.00-NT	1	0.990	25.1	1.010	25.7	1.260	32.0	0.035	0.89	2-1/4	57
CVL01-1.25-NT	1-1/4	1.210	30.7	1.250	31.8	1.539	39.1	0.035	0.89	3	76
CVL01-1.50-NT	1-1/2	1.520	38.6	1.540	39.1	1.870	47.5	0.044	1.12	3-1/2	89
CVL01-1.75-NT	1-3/4	1.690	42.9	1.750	44.5	2.100	53.3	0.040	1.02	4-1/4	108
CVL01-2.00-NT	2	2.010	51.1	2.030	51.6	2.370	60.2	0.043	1.09	4-3/4	121

** Minimum 36 length.

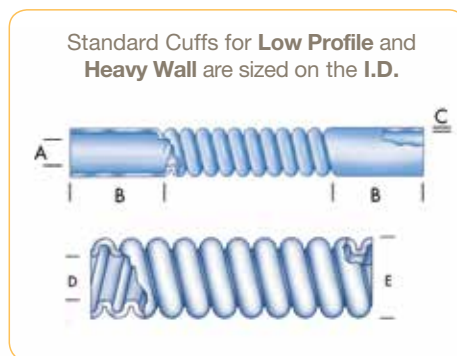
**PTFE Heavy Wall Convoluted**

(Standard tubing is natural)

Part Number	Size To Order	Min. Inside Diameter		Max. Inside Diameter		Max. Outside Diameter		Wall Thickness		**Min. Bend Radius	
		inch	mm	inch	mm	inch	mm	inch	mm	inch	mm
CVH01-1/4-NT	1/4	0.257	6.5	0.265	6.7	0.415	10.5	0.025	0.38	3/4	19
CVH01-3/8-NT	3/8	0.335	8.5	0.345	8.8	0.510	13.0	0.025	0.64	1	25
CVH01-1/2-NT	1/2	0.454	11.5	0.466	11.8	0.700	17.8	0.035	0.89	1-1/2	38
CVH01-3/4-NT	3/4	0.683	17.4	0.701	17.8	1.010	25.7	0.500	1.27	1.88	48
CVH01-1.00-NT	1	0.841	21.4	0.859	21.8	1.210	30.7	0.053	1.35	2-1/2	64
CVH01-1.25-NT	1-1/4	1.125	28.6	1.145	29.1	1.610	40.9	0.062	1.57	3.13	79
CVH01-1.50-NT	1-1/2	1.420	36.1	1.480	37.6	1.880	47.8	0.062	1.57	3-3/4	95
CVH01-1.75-NT	1-3/4	1.540	39.1	1.600	40.6	2.100	53.3	0.062	1.57	4-1/2	114
CVH01-2.00-NT	2	1.770	45.0	1.830	46.5	2.432	61.8	0.062	1.57	4-3/4	120
CVH01-2.50-NT	2-1/2	2.460	62.5	2.540	64.5	3.210	81.5	0.062	1.57	5	127
CVH01-3.00-NT	3	2.940	74.7	3.060	77.7	3.750	95.3	0.062	1.57	7	178
CVH01-4.00-NT	4	3.90	100	4.060	103	4.750	121	0.070	1.77	9	229

** Minimum 36 length.

For detailed ordering information, please consult price list or contact Parflex® Division.

PTFE Convoluted

Series SAE AS81914/1 and SAE AS81914/2



Features

- Chemically inert
- Low coefficient of friction
- Very flexible
- Self extinguishing
- Non-wetting

Certifications

- AMS 3653E
- SAE AS81914/1
- SAE AS81914/2
- FDA Compliant

Applications/Markets



- Fluid Handling
- Harnesses
- Crush Resistant Cover
- Robotics

Order Information

Example: 81914/1-1010-0TC

81914/1-1010-0TC – SAE AS81914 Convoluted

81914/1-1010-0TC – **PTFE**

81914/1-**1010**-0TC – **Helical Convolutions**

81914/1-10**10**-0TC – **Size (10=1.000")**

81914/1-1010-**0TC** – **Color (0=Black)**

81914/1-1010-**0TC** – **"T" is bulk** - (for cuffed tubing, remove "T" and add length, ie. 81914/1-1010-01200 = 187" Convo, black, cut 12" long

Notes

- Working Temperature: 500°F (260°C)
- Tubing is provided in black without cuffs direct from inventory
- Stock packaging is random coils
- Also available in close convolution 81914/2
- Minimum quantities may apply
- Custom packaging, sizes, lengths, cuffs and colors are quoted upon request

Colors

- ● Black
- Colors available as custom run, see color code table

When ordering convoluted tubing in colors, the "N" designation for natural should be replaced by the correct color designator;

ie 81914/1-101-0T (black bulk tubing)

ie 81914/1-101-01200 (black tubing - 12 inches long)

Color Code					
○	N	Natural	●	5	Green
●	0	Black	●	6	Blue
●	1	Brown	●	7	Violet
●	2	Red	●	8	Gray
●	3	Orange	○	9	White
●	4	Yellow			

PTFE Convuluted Tubing (SAE AS81914/1)

(Standard tubing is black)

Part Number	MIL Spec*	Maximum Inside Diameter		Minimum Inside Diameter		Maximum Outside Diameter		Maximum Wall Thickness		Minimum Bend Radius		Pitch ±1	Weight	
		inch	mm	inch	mm	inch	mm	inch	mm	inch	mm		lb./100 ft.	kg./100 mtr.
81914/1-1001-OTC	-1	0.188	4.78	0.181	4.6	0.320	8.13	0.023	0.584	1/2	13	8	2	2.98
81914/1-1002-OTC	-2	0.281	7.14	0.273	6.93	0.414	10.5	0.027	0.686	3/4	19	7.5	2.9	4.31
81914/1-1003-OTC	-3	0.312	7.93	0.303	7.7	0.450	11.4	0.027	0.686	7/8	22	7.5	3.6	5.36
81914/1-1004-OTC	-4	0.375	9.53	0.364	9.25	0.530	13.5	0.029	0.737	1	25	7	4.2	6.25
81914/1-1005-OTC	-5	0.437	11.1	0.425	10.8	0.590	15.0	0.029	0.737	1-1/4	32	7	4.9	7.29
81914/1-1006-OTC	-6	0.500	12.7	0.485	12.3	0.660	16.8	0.029	0.737	1-1/2	38	7	5.2	7.74
81914/1-1007-OTC	-7	0.625	15.9	0.608	15.4	0.780	19.9	0.035	0.889	1-3/4	44	7	6.9	10.3
81914/1-1008-OTC	-8	0.750	19.1	0.730	18.5	0.975	24.8	0.035	0.889	1.88	48	6	10.4	15.5
81914/1-1009-OTC	-9	0.875	22.2	0.850	21.6	1.100	27.9	0.035	0.889	2-1/4	57	6	11.3	16.8
81914/1-1010-OTC	-10	1.000	25.4	0.975	24.8	1.260	32.0	0.035	0.889	2-1/2	64	4.5	12.6	18.8
81914/1-1011-OTC	-11	1.125	28.6	1.100	27.9	1.390	35.3	0.035	0.889	2-3/4	70	4.5	13.8	20.5
81914/1-1012-OTC	-12	1.250	31.8	1.210	30.7	1.539	39.1	0.035	0.889	3	76	4	15.5	23.1
81914/1-1013-OTC	-13	1.500	38.1	1.440	36.6	1.850	47.0	0.040	1.020	3.75	95	4	21.7	32.3
81914/1-1014-OTC	-14	1.750	44.5	1.690	42.9	2.100	53.3	0.045	1.140	4.25	108	4	25.3	37.6
81914/1-1015-OTC	-15	2.000	50.8	1.940	49.3	2.350	59.7	0.045	1.140	4.75	121	4	29	43.2

*PTFE convuluted tubing is provided in BLACK without cuffs direct from the factory. Black part numbers are designated with "OT" and Natural part numbers are designated with "NT" after the Mil Spec number (ie 81914/1-1014-OT).

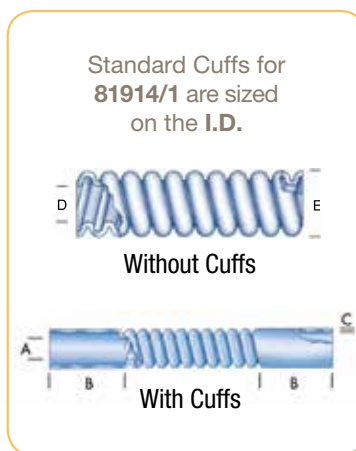

For detailed ordering information, please consult price list or contact Parflex® Division.

FEP Tubing

Series Fractional & Metric: 103, 203

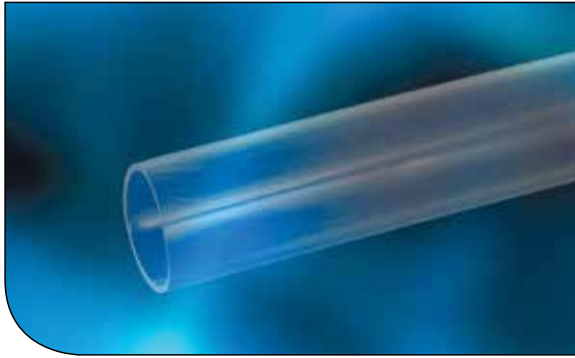

Features

- Virgin Fluorinated Ethylene Propylene resin
- Translucent
- Chemically inert
- Long continuous lengths
- Low coefficient of friction
- Self extinguishing
- Non-wetting
- Weldable

Certifications/Compliance

- ASTM D3307-10
- ASTM D2116-07
- VW-1, UL-83 (natural)
- FDA Compliant
- USP Class VI Compliant

Applications/Markets



- Nitrogen Transfer
- Ozone Sampling
- Optical Sensor
- Laboratory
- Down Hole Pump
- Food & Beverage
- Catheter Repair
- Syringe Tips

Order Information

Example: 103-0250031-N-100

103-0250031-N-100 – **Fractional**

103-0250031-N-100 – **FEP**

103-**0250**031-N-100 – **Tube O.D.** in inches (**1/4"**)

103-0250**031**-N-100 – **Tube Wall Thickness** in inches (**.031"**)

103-0250031-**N**-100 – **Natural**

103-0250031-N-**100** – **Package Quantity** in feet (**100'**)

Fittings

Fittings available for sizes 1/8" up to 1"

Parker Fittings available from:
Fluid System Connectors Division
Otsego, MI

(269) 694-2550

(269) 692-6634 FAX

FSC Product Families:

- Compression
- Compress-Align®
- TrueSeal™

Notes

- Working Temperature:
-100°F to 400°F (-75°C to 204°C)
- Working pressure calculated using a Design Factor of 4 at
73°F (23°C)
- Custom packaging and sizes are quoted upon request
- Package quantities are not continuous

Options

- Smoothbore
- Convolute
- Corrugated
- Retractable Coils
- Paratubing

Colors

- ○ Natural, Translucent
- Colors available as custom run, see color code table

Color Code					
○	N	Natural	●	5	Green
●	0	Black	●	6	Blue
●	1	Brown	●	7	Violet
●	2	Red	●	8	Gray
●	3	Orange	○	9	White
●	4	Yellow			

103 FEP Industrial Wall Fractional Size Tubing

Part Number	Order Size	Nominal O.D.				Nominal I.D.				Reference Wall		Working Pressure		Burst Pressure		Min. Bend Radius		Vac. Rating	Weight	
		inch	inch	tol.	mm	tol.	inch	tol.	mm	tol.	inch	mm	psi 73°F	bar 23°C	psi 73°F	bar 23°C	inch		mm	at 73°F
#																				
103-0094031	3/32	0.094	±0.005	2.40	±0.127	0.031	±0.002	0.79	±0.051	0.031	0.79	630	43	2520	174	0.500	13	28	0.006	0.009
103-0125031	1/8	0.125	±0.003	3.18	±0.076	0.062	±0.003	1.57	±0.076	0.031	0.79	470	32	1880	130	0.375	10	28	0.009	0.013
103-0156031	5/32	0.157	±0.005	3.99	±0.127	0.094	±0.005	2.39	±0.127	0.031	0.79	360	25	1440	99	0.375	10	28	0.011	0.017
103-0188031	3/16	0.188	±0.005	4.78	±0.127	0.125	±0.005	3.18	±0.127	0.031	0.79	290	20	1160	80	0.750	19	28	0.014	0.021
103-0250031	1/4	0.250	±0.005	6.35	±0.127	0.188	±0.005	4.78	±0.127	0.031	0.79	210	14	840	58	1.750	44	28	0.020	0.030
103-0312031	5/16	0.312	±0.005	7.92	±0.127	0.250	±0.005	6.35	±0.127	0.031	0.79	160	11	640	44	2.250	57	28	0.025	0.038
103-0375031	3/8	0.375	±0.005	9.52	±0.127	0.312	±0.005	7.92	±0.127	0.031	0.79	130	9	520	36	2.750	70	28	0.031	0.047
103-0438031	7/16	0.438	±0.005	11.13	±0.127	0.375	±0.005	9.52	±0.127	0.031	0.79	110	8	440	30	4.000	102	28	0.037	0.055
103-0500031	1/2	0.500	±0.006	12.70	±0.152	0.438	±0.006	11.13	±0.152	0.031	0.79	90	6	360	25	4.000	102	28	0.043	0.063
103-0563031	9/16	0.563	±0.006	14.30	±0.152	0.500	±0.006	12.70	±0.152	0.031	0.79	80	6	320	22	5.000	127	28	0.054	0.080

103 FEP Heavy Wall Fractional Size Tubing

Part Number	Order Size	Nominal O.D.				Nominal I.D.				Reference Wall		Working Pressure		Burst Pressure		Min. Bend Radius		Vac. Rating	Weight	
		inch	inch	tol.	mm	tol.	inch	tol.	mm	tol.	inch	mm	psi 73°F	bar 23°C	psi 73°F	bar 23°C	inch		mm	at 73°F
#																				
103-0188062	3/16	0.188	±0.005	4.78	±0.127	0.064	±0.005	1.63	±0.127	0.062	1.57	630	43	2520	174	0.250	6	28	0.023	0.034
103-0250040	1/4	0.250	±0.005	6.35	±0.127	0.170	±0.005	4.32	±0.127	0.040	1.02	280	19	1120	77	1.250	32	28	0.025	0.037
103-0250047	1/4	0.250	±0.005	6.35	±0.127	0.156	±0.005	3.96	±0.127	0.047	1.19	340	23	1360	94	0.750	19	28	0.028	0.042
103-0250062	1/4	0.250	±0.005	6.35	±0.127	0.125	±0.005	3.18	±0.127	0.062	1.57	470	32	1880	130	0.750	19	28	0.034	0.051
103-0312062	5/16	0.312	±0.005	7.92	±0.127	0.188	±0.005	4.78	±0.127	0.062	1.57	360	25	1440	99	1.375	35	28	0.045	0.068
103-0375062	3/8	0.375	±0.005	9.52	±0.127	0.250	±0.005	6.35	±0.127	0.062	1.57	290	20	1160	80	1.500	38	28	0.057	0.085
103-0438062	7/16	0.438	±0.005	11.13	±0.127	0.312	±0.005	7.92	±0.127	0.062	1.57	250	17	1000	69	2.625	67	28	0.068	0.102
103-0500062	1/2	0.500	±0.005	12.70	±0.127	0.375	±0.005	9.53	±0.127	0.062	1.57	210	14	840	58	2.125	54	28	0.079	0.119
103-0625062	5/8	0.625	±0.006	15.88	±0.152	0.500	±0.006	12.70	±0.152	0.062	1.57	160	11	640	44	3.000	76	28	0.102	0.152
103-0750062	3/4	0.750	±0.006	19.05	±0.152	0.625	±0.006	15.88	±0.152	0.062	1.57	130	9	520	36	6.000	152	28	0.125	0.186
103-1000062	1	1.000	±0.010	25.40	±0.254	0.875	±0.010	22.22	±0.254	0.062	1.57	90	6	360	25	8.000	203	28	0.170	0.254

203 Metric FEP Tubing

Part Number	Order Size	Nominal O.D.				Nominal I.D.				Reference Wall		Working Pressure		Burst Pressure		Min. Bend Radius		Vac. Rating	Weight	
		mm	mm	tol.	inch	tol.	mm	tol.	inch	tol.	mm	inch	bar 23°C	psi 73°F	bar 23°C	psi 73°F	mm		inch	at 73°F
#																				
203-0300100	3	3	±0.11	0.118	±0.004	1	±0.11	0.039	±0.004	1	0.039	27	390	108	1560	6	0.250	28	0.014	0.009
203-0400100	4	4	±0.11	0.157	±0.004	2	±0.11	0.079	±0.004	1	0.039	20	290	80	1160	13	0.500	28	0.020	0.014
203-0500100	5	5	±0.11	0.197	±0.004	3	±0.11	0.118	±0.004	1	0.039	15	220	61	880	19	0.750	28	0.027	0.018
203-0600100	6	6	±0.13	0.236	±0.005	4	±0.13	0.157	±0.005	1	0.039	12	180	50	720	29	1.125	28	0.034	0.023
203-0700100	7	7	±0.13	0.276	±0.005	5	±0.13	0.197	±0.005	1	0.039	10	150	41	600	44	1.750	28	0.041	0.027
203-0800100	8	8	±0.13	0.315	±0.005	6	±0.13	0.236	±0.005	1	0.039	9	130	36	520	51	2.000	28	0.047	0.032
203-0900100	9	9	±0.13	0.354	±0.005	7	±0.13	0.275	±0.005	1	0.039	8	110	30	440	54	2.125	28	0.054	0.036
203-1000100	10	10	±0.13	0.393	±0.005	8	±0.13	0.315	±0.005	1	0.039	7	100	28	400	70	2.750	28	0.061	0.041
203-1200100	12	12	±0.15	0.472	±0.006	10	±0.15	0.394	±0.006	1	0.039	6	80	22	320	76	3.000	28	0.074	0.050

For detailed ordering information, please consult price list or contact Parflex® Division.



FEP Heat Shrinkable Tubing

Series 1.3:1 HS1.3FEP

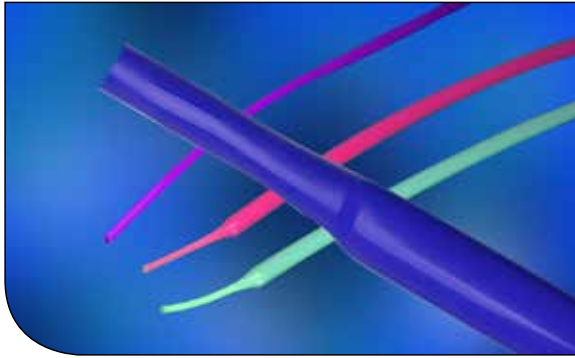

Features

- Easier to shrink than PTFE
- Chemically inert
- Low coefficient of friction
- Superior dielectric strength
- Good heat resistance
- Self extinguishing
- Non-wetting

Certifications

- AMS-DTL-23053/11A, Class 1
- ASTM D2902 Type II
- ASTM D3296-03
- VW-1, UL-83 (natural)
- FDA Compliant
- USP Class VI Compliant

Applications/Markets



- Protective Cover
- UV Light Covering
- Product Testing
- Rollers

Order Information

Example: HS1.3FEP24-0CC48.000

HS1.3FEP24-0CC48.000 – Heat Shrink

HS1.3FEP24-0CC48.000 – Shrink Ratio (1.3:1)

HS1.3FEP24-0CC48.000 – FEP

HS1.3FEP24-0CC48.000 – Heat Shrink Size in AWG

(AWG 24) (For inch size use inch (3/8"))

HS1.3FEP24-0CC48.000 – Black

HS1.3FEP24-0CC48.000 – Package Quantity in feet (48")

Notes

- Working Temperature: 400°F (204°C)
- Shrink Temperature:
1" Dia. and below : 410°F (210°C)
Over 1" Dia. : 430°F (221°C)
- *Dielectric Strength: $\geq 2,000$ V/M, per ASTM D 149 short term test of 10 MIL thickness (Volts/MIL)
- Heat Shrink tubing is available in stock packaging of 4-ft. straight lengths
- Minimum quantities may apply
- Custom packaging, sizes, lengths and colors are quoted upon request

Colors

- ○ Natural, Translucent
- Colors available as custom run, see color code table

When ordering coiled tubing in colors, the color code is always followed by TC; when ordering cut lengths, the color code is followed by CC
ie HS1.3FEP24-2TC
ie HS1.3FEP24-0CC48.000

Color Code					
○	N	Natural	●	5	Green
●	0	Black	●	6	Blue
●	1	Brown	●	7	Violet
●	2	Red	●	8	Gray
●	3	Orange	○	9	White
●	4	Yellow			

HS1.3FEP AWG Heat Shrink Tubing (1.3:1)

Part Number	Order Size AWG	Mil Spec*	Minimum Expanded I.D.		Maximum Recovered I.D.		Nominal Recovered Wall	
			inch	mm	inch	mm	inch	mm
HS1.3FEP24	24	23053/11A-101	0.031	0.79	0.027	0.69	0.008 ± 0.002	0.20 ± 0.05
HS1.3FEP22	22	23053/11A-102	0.036	0.91	0.032	0.81	0.008 ± 0.002	0.20 ± 0.05
HS1.3FEP20	20	23053/11A-103	0.045	1.14	0.039	0.99	0.008 ± 0.002	0.20 ± 0.05
HS1.3FEP18	18	23053/11A-104	0.060	1.52	0.049	1.25	0.008 ± 0.002	0.20 ± 0.05
HS1.3FEP16	16	23053/11A-105	0.075	1.90	0.061	1.55	0.009 ± 0.002	0.23 ± 0.05
HS1.3FEP14	14	23053/11A-106	0.092	2.34	0.072	1.83	0.009 ± 0.002	0.23 ± 0.05
HS1.3FEP12	12	23053/11A-107	0.115	2.92	0.089	2.26	0.009 ± 0.002	0.23 ± 0.05
HS1.3FEP10	10	23053/11A-108	0.141	3.58	0.114	2.90	0.010 ± 0.003	0.25 ± 0.08
HS1.3FEP09	9	23053/11A-109	0.158	4.01	0.124	3.15	0.010 ± 0.003	0.25 ± 0.08
HS1.3FEP08	8	23053/11A-110	0.180	4.57	0.143	3.63	0.010 ± 0.003	0.25 ± 0.08
HS1.3FEP07	7	23053/11A-111	0.197	5.00	0.158	4.01	0.011 ± 0.004	0.28 ± 0.10
HS1.3FEP06	6	23053/11A-112	0.225	5.72	0.180	4.57	0.011 ± 0.004	0.28 ± 0.10
HS1.3FEP05	5	23053/11A-113	0.248	6.30	0.198	5.03	0.011 ± 0.004	0.28 ± 0.10
HS1.3FEP04	4	23053/11A-114	0.290	7.37	0.226	5.74	0.011 ± 0.004	0.28 ± 0.10
HS1.3FEP03	3	23053/11A-115	0.310	7.87	0.249	6.32	0.011 ± 0.004	0.28 ± 0.10
HS1.3FEP02	2	23053/11A-116	0.365	9.27	0.280	7.11	0.012 ± 0.004	0.31 ± 0.10
HS1.3FEP01	1	23053/11A-117	0.400	10.2	0.311	7.90	0.012 ± 0.004	0.31 ± 0.10
HS1.3FEP00	0	23053/11A-118	0.440	11.2	0.349	8.86	0.012 ± 0.004	0.31 ± 0.10

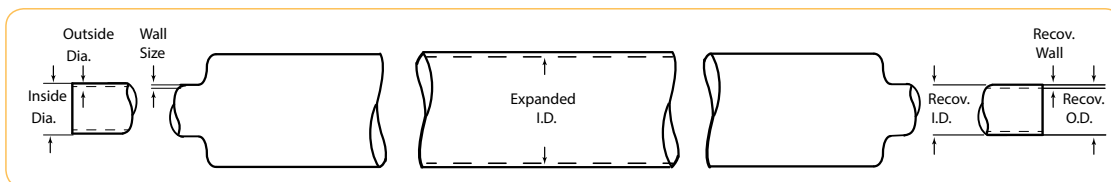

HS1.3FEP Fractional Heat Shrink Tubing (1.3:1)

Part Number	Order Size inch	Mil Spec*	Minimum Expanded I.D.		Maximum Recovered I.D.		Nominal Recovered Wall	
			inch	mm	inch	mm	inch	mm
HS1.3FEP3/8	3/8	23053/11A-119	0.500	12.7	0.383	9.73	0.015 ± 0.004	0.38 ± 0.10
HS1.3FEP7/16	7/16	23053/11A-120	0.580	14.7	0.448	11.4	0.020 ± 0.004	0.51 ± 0.10
HS1.3FEP1/2	1/2	23053/11A-121	0.666	16.9	0.510	13.0	0.020 ± 0.004	0.51 ± 0.10
HS1.3FEP5/8	5/8	23053/11A-122	0.830	21.1	0.637	16.2	0.025 ± 0.004	0.64 ± 0.10
HS1.3FEP3/4	3/4	23053/11A-123	1.000	25.4	0.764	19.4	0.030 ± 0.004	0.76 ± 0.10
HS1.3FEP7/8	7/8	23053/11A-124	1.170	29.7	0.891	22.6	0.035 ± 0.004	0.89 ± 0.10
HS1.3FEP1.00	1	23053/11A-126	1.330	33.8	1.020	25.9	0.035 ± 0.004	0.89 ± 0.10
HS1.3FEP1.13	1-1/8	23053/11A-133	1.500	38.1	1.145	29.1	0.035 ± 0.004	0.89 ± 0.10
HS1.3FEP1.25	1-1/4	23053/11A-134	1.666	42.3	1.270	32.3	0.035 ± 0.004	0.89 ± 0.10
HS1.3FEP1.38	1-3/8	23053/11A-135	1.833	46.6	1.390	35.3	0.035 ± 0.004	0.89 ± 0.10
HS1.3FEP1.50	1-1/2	23053/11A-136	2.000	50.8	1.520	38.6	0.035 ± 0.004	0.89 ± 0.10

For detailed ordering information, please consult price list or contact Parflex® Division.

FEP Heat Shrinkable Tubing

Series 1.67:1 HS1.6FEP

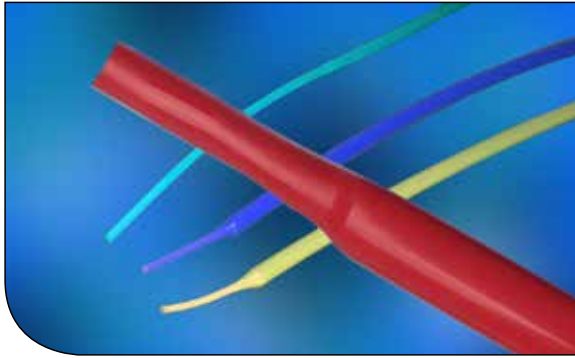

Features

- Easier to shrink than PTFE
- Chemically inert
- Low coefficient of friction
- Superior dielectric strength
- Good heat resistance
- Self extinguishing
- Non-wetting

Certifications

- AMS-DTL-23053/11A, Class 2
- ASTM 2902 Type II
- ASTM D3296-03
- VW-1, UL-83 (natural)
- FDA Compliant
- USP Class VI Compliant

Applications/Markets



- Protective Cover
- UV Light Covering
- Product Testing
- Rollers

Order Information

Example: HS1.6FEP3/32-NC48.000

HS1.6FEP3/32-NC48.000 – Heat Shrink

HS1.6FEP3/32-NC48.000 – Shrink Ratio (1.67:1)

HS1.6FEP3/32-NC48.000 – FEP

HS1.6FEP3/32-NC48.000 – Heat Shrink Size in inches (3/32")

HS1.6FEP3/32-NC48.000 – Natural

HS1.6FEP3/32-NC48.000 – Cut Tubing

HS1.6FEP3/32-NC48.000 – Package Quantity in feet (48")

Notes

- Working Temperature: 400°F (204°C)
- Shrink Temperature:
1" Dia. and below: 410°F (210°C)
Over 1" Dia.: 430°F (221°C)
- *Dielectric Strength: $\geq 2,000$ V/M, per ASTM D 149 short term test of 10 MIL thickness (Volts/MIL)
- Heat Shrink tubing is available in stock packaging of 4-ft. straight lengths
- Minimum quantities may apply
- Custom packaging, sizes, lengths and colors are quoted upon request

Colors

- ○ Natural, Translucent
- Colors available as custom run, see color code table

When ordering coiled tubing in colors, the color code is always followed by TC; when ordering cut lengths, the color code is followed by CC
ie HS1.6FEP3/32-2TC
ie HS1.6FEP3/32-0CC48.000

Color Code					
○	N	Natural	●	5	Green
●	0	Black	●	6	Blue
●	1	Brown	●	7	Violet
●	2	Red	●	8	Gray
●	3	Orange	○	9	White
●	4	Yellow			

HS1.6FEP Fractional Heat Shrink Tubing (1.67:1)

Part Number	Order Size inch	Mil Spec*	Minimum Expanded I.D.		Maximum Recovered I.D.		Nominal Recovered Wall	
			inch	mm	inch	mm	inch	mm
HS1.6FEP3/32	3/32	23053/11A-201	0.093	2.36	0.056	1.42	0.008 ± 0.003	0.20 ± 0.08
HS1.6FEP1/8	1/8	23053/11A-202	0.125	3.18	0.075	1.90	0.010 ± 0.003	0.25 ± 0.08
HS1.6FEP3/16	3/16	23053/11A-203	0.188	4.78	0.115	2.92	0.010 ± 0.003	0.25 ± 0.08
HS1.6FEP1/4	1/4	23053/11A-204	0.250	6.35	0.150	3.81	0.010 ± 0.003	0.25 ± 0.08
HS1.6FEP3/8	3/8	23053/11A-205	0.375	9.52	0.225	5.72	0.012 ± 0.003	0.31 ± 0.08
HS1.6FEP1/2	1/2	23053/11A-206	0.500	12.7	0.300	7.62	0.015 ± 0.004	0.38 ± 0.10
HS1.6FEP3/4	3/4	23053/11A-207	0.750	19.1	0.450	11.4	0.020 ± 0.004	0.51 ± 0.10
HS1.6FEP1.00	1	23053/11A-208	1.000	25.4	0.600	15.2	0.025 ± 0.005	0.64 ± 0.13
HS1.6FEP1.50	1-1/2	23053/11A-209	1.500	38.1	0.900	22.9	0.030 ± 0.005	0.76 ± 0.13
HS1.6FEP2.00	2	23053/11A-210	2.000	50.8	1.200	30.5	0.030 ± 0.005	0.76 ± 0.13

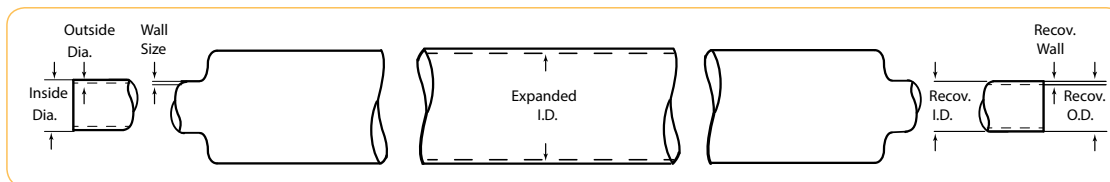

For detailed ordering information, please consult price list or contact Parflex® Division.

FEP Heat Shrinkable Roll Cover

Series 1.25:1 HS1.25FEP



Features

- Extends roller life
- Eliminates roller build up and picking
- Low coefficient of friction
- Flexible
- Good heat resistance

Certifications

- ASTM D2902 Type II
- VW-1, UL-83 (natural)

Applications/Markets



- Protective Cover
- Rollers

Order Information

Example: HS1.25FEP3.50-NC48.000

HS1.25FEP3.50-NC48.000 – Heat Shrink

HS1.25FEP3.50-NC48.000 – Shrink Ratio (1.25:1)

HS1.25FEP3.50-NC48.000 – FEP

HS1.25FEP3.50-NC48.000 – Heat Shrink Expanded

Size inches (3 1/2 in)

HS1.25FEP3.50-NC48.000 – Natural

HS1.25FEP3.50-NC48.000 – Cut Tubing

HS1.25FEP3.50-NC48.000 – Package Quantity in feet (48")

Notes

- Working Temperature: 400°F (204°C)
- Shrink Temperature:
347°F (175°C) for 10 minutes - For high temperatures 500°F (260°C), PFA roll covers are available
- Dielectric Strength: $\geq 2,000$ V/M, per ASTM D 149 short term test of 10 MIL thickness (Volts/MIL)
- Roll Cover is available in stock packaging of 4-ft. straight lengths
- Custom packaging, sizes, lengths and colors are quoted upon request
- For adhesion purposes, roll covers must be etched; Etching is available on the inside diameter, outside diameter or both
- Minimum quantities may apply

Colors

- ○ Natural, Translucent

HS1.25.1 FEP Roll Cover

Part Number	Order Size	Minimum Expanded I.D.		Maximum Recovered I.D.		Nominal Recovered Wall	
		inch	mm	inch	mm	inch	mm
HS1.25FEP1/2	1/2	0.550	14.0	0.440	11.2	0.020 ± 0.004	0.508 ± 0.10
HS1.25FEP5/8	5/8	0.700	17.8	0.540	13.7	0.020 ± 0.004	0.508 ± 0.10
HS1.25FEP3/4	3/4	0.800	20.3	0.640	16.3	0.020 ± 0.004	0.508 ± 0.10
HS1.25FEP7/8	7/8	0.950	24.1	0.760	19.3	0.020 ± 0.004	0.508 ± 0.10
HS1.25FEP1.00	1	1.100	27.9	0.880	22.4	0.020 ± 0.004	0.508 ± 0.10
HS1.25FEP1.25	1 1/4	1.300	33.0	1.000	25.4	0.020 ± 0.004	0.508 ± 0.10
HS1.25FEP1.50	1-1/2	1.700	43.2	1.300	33.0	0.020 ± 0.004	0.508 ± 0.10
HS1.25FEP2.00	2	2.100	53.3	1.700	43.2	0.020 ± 0.004	0.508 ± 0.10
HS1.25FEP2.25	2-1/4	2.260	59.7	2.000	50.8	0.020 ± 0.004	0.508 ± 0.10
HS1.25FEP2.50	2-1/2	2.600	66.0	2.100	53.3	0.020 ± 0.004	0.508 ± 0.10
HS1.25FEP3.00	3	3.100	78.7	2.600	66.0	0.020 ± 0.004	0.508 ± 0.10
HS1.25FEP3.50	3-1/2	3.500	88.9	3.100	78.7	0.020 ± 0.004	0.508 ± 0.10
HS1.25FEP4.00	4	4.300	109.2	3.500	88.9	0.020 ± 0.004	0.508 ± 0.10
HS1.25FEP5.00	5	5.200	132.1	4.300	109.3	0.020 ± 0.004	0.508 ± 0.10
HS1.25FEP6.00	6	6.200	157.5	5.200	132.1	0.020 ± 0.004	0.508 ± 0.10
HS1.25FEP7.00	7	7.200	182.9	6.200	157.5	0.020 ± 0.004	0.508 ± 0.10
HS1.25FEP8.00	8	8.300	210.8	7.200	182.9	0.020 ± 0.004	0.508 ± 0.10



FEP/PTFE Heat Shrinkable Double Shrink Series TSSS and TSSL



Features

- Double Shrink encapsulates your parts as the FEP melts during the PTFE shrinking process
- Protects cables, tubes and other objects from moisture and dirt
- Self extinguishing

Certifications

- VW-1, UL-83 (natural)

Applications/Markets



- Wire splices
- Encapsulates fittings

FEP/PTFE Double Shrink Tubing

Part Number	Minimum Expanded I.D.		Maximum Recovered I.D.		Nominal Recovered Wall	
	inch	mm	inch	mm	inch	mm
Standard Wall						
TSSS036	0.036	0.91	0.00	0.00	0.023	0.584
TSSS060	0.060	1.52	0.00	0.00	0.028	0.711
TSSS130	0.130	3.30	0.00	0.00	0.032	0.813
TSSS160	0.160	4.06	0.00	0.00	0.032	0.813
TSSS190	0.190	4.83	0.061	1.55	0.035	0.889
TSSS250	0.250	6.35	0.125	3.18	0.035	0.889
TSSS350	0.350	8.89	0.190	4.83	0.035	0.889
TSSS450	0.450	11.4	0.312	7.92	0.055	1.400
TSSS700	0.700	17.8	0.440	11.2	0.055	1.400
TSSS950	0.950	24.1	0.680	17.3	0.065	1.650

Light Wall						
TSSL065	0.065	1.65	0.00	0.00	0.015	0.381
TSSL115	0.115	2.92	0.045	1.14	0.015	0.381
TSSL130	0.130	3.30	0.060	1.52	0.015	0.381
TSSL180	0.180	4.57	0.065	1.65	0.015	0.381
TSSL190	0.190	4.83	0.070	1.78	0.015	0.381
TSSL240	0.240	6.10	0.150	3.81	0.020	0.508
TSSL350	0.350	8.89	0.210	5.33	0.025	0.635
TSSL480	0.480	12.2	0.315	8.00	0.032	0.813
TSSL700	0.700	17.8	0.500	12.7	0.040	1.020
TSSL1000	1	25.4	0.700	17.8	0.045	1.140

Order Information

Example: TSSL036-NC48.000

- TSSL036-NC48.000 – **Double Shrink**
- TSSL036-NC48.000 – **Light Wall**
- TSSL**036**-NC48.000 – **Size in inches (0.036")**
- TSSL036-NC**48.000** – **Natural**
- TSSL036-NC**48.000** – **Cut Tubing**
- TSSL036-NC**48.000** – **Package Quantity in feet (48")**

Notes

- Working Temperature: 450°F (231°C)
- Shrink Temperature: 680°F (360°C)
- Longitudinal Change: +/- 10%
- Heat Shrink tubing is available in stock packaging of 4-ft. straight lengths
- Custom packaging, sizes, lengths and colors are quoted upon request
- Minimum quantities may apply

Colors

- ○ Natural, Translucent

For detailed ordering information, please consult price list or contact Parflex® Division.

FEP Convoluted Tubing

Series: CV03 and Convo-Flon™



Features

- Cuffs are sized on the I.D.
- Very flexible
- Long continuous lengths
- Translucent
- Chemically inert
- Good flexlife

Certifications/Compliance

- ASTM D3296-03
- VW-1, UL-83 (natural)

Applications/Markets



- Fluid Transport
- Vascular Graft
- Laboratory
- Robotics

Order Information

Example: CV03-1-1/2-NT

CV03-1-1/2-NT – Convoluted Tubing

CV03-1-1/2-NT – FEP

CV03-1-1/2-NT – Tube Size in inches (1-1/2")

CV03-1-1/2-NT – Natural

Notes

- Working Temperature: -100°F to 400°F (-75°C to 204°C)

Colors

- ○ Natural, Translucent

FEP Convoluted

(Standard tubing is natural)

Part Number	Order Size inch	Standard Cuff I.D. "A"		Standard Cuff Length "B"		Wall Thickness "C"		Min. Inside Diameter "D"		Max. Inside Diameter		Max. Outside Diameter "E"		**Min. Bend Radius	
		inch	mm	inch	mm	inch	mm	inch	mm	inch	mm	inch	mm	inch	mm
CV03-1/4-NT	1/4	1/4	6.35	3/4	19.1	0.020	0.508	0.251	6.38	0.265	6.73	0.405	10.3	0.365	9
CV03-5/16-NT	5/16	5/16	7.94	1	25.4	0.023	0.584	0.273	6.93	0.281	7.14	0.424	10.8	0.500	13
CV03-3/8-NT	3/8	3/8	9.53	1	25.4	0.023	0.584	0.364	9.25	0.375	9.53	0.530	13.5	0.875	22
CV03-1/2-NT	1/2	1/2	12.7	1	25.4	0.025	0.635	0.485	12.3	0.500	12.7	0.660	16.8	0.625	16
CV03-5/8-NT	5/8	5/8	15.9	1-1/4	31.8	0.025	0.635	0.609	15.5	0.625	15.9	0.780	19.8	1.500	38
CV03-3/4-NT	3/4	3/4	19.1	1-1/2	38.1	0.025	0.635	0.730	18.5	0.750	19.1	0.975	24.8	3.500	89
CV03-1.00-NT	1	1	25.4	2	50.8	0.030	0.762	0.975	24.8	1.000	25.4	1.260	32.0	2.250	57
CV03-1.25-NT	1-1/4	1-1/4	31.8	2-1/2	63.5	0.040	1.02	1.210	30.7	1.250	31.8	1.540	39.1	2.500	64
CV03-1.50-NT	1-1/2	1-1/2	38.1	2-1/2	63.5	0.045	1.14	1.490	37.8	1.530	38.9	1.940	49.2	3.000	76
CV03-2.00-NT	2	2	50.8	2-1/2	63.5	0.045	1.14	1.990	50.5	2.020	51.3	2.370	60.2	4.250	108
CV03-2.50-NT	2-1/2	2-1/2	63.5	3	73.2	0.065	1.65	2.440	61.9	2.500	63.5	3.000	76.2	6.500	165
CV03-3.00-NT	3	3	76.2	3	73.2	0.065	1.65	2.92	74.2	3.02	76.7	3.74	95.0	7.500	191

** Minimum 36" length.

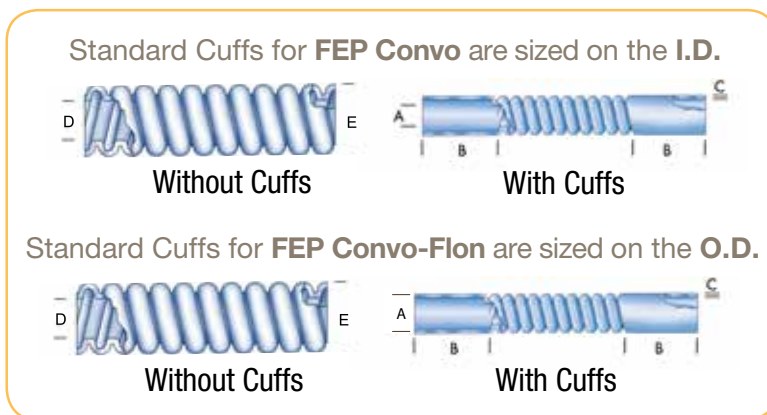

FEP Convo-Flon™ Convoluted

(Standard tubing is natural)

Part Number	Order Size inch	Standard Cuff O.D. "A"		Standard Cuff Length "B"		Wall Thickness "C"		Min. Inside Diameter "D"		Max. Inside Diameter		Max. Outside Diameter "E"		**Min. Bend Radius	
		inch	mm	inch	mm	inch	mm	inch	mm	inch	mm	inch	mm	inch	mm
Contact Customer Service	1/4 x 3/8	1/4	6.35	3/4	19.1	0.020	0.508	0.251	6.38	0.265	6.73	0.375	9.53	0.625	16
	3/8 x 1/2	5/16	7.94	1	25.4	0.023	0.584	0.364	9.25	0.375	9.53	0.500	12.7	0.875	22
	1/2 x 5/8	3/8	9.53	1	25.4	0.025	0.635	0.480	12.2	0.500	12.7	0.625	15.9	1.250	32
	5/8 x 3/4	1	25.4	2	50.8	0.025	0.635	0.609	15.5	0.625	15.9	0.750	19.1	1.500	38
	3/4 x 7/8	1-1/4	31.8	2-1/2	63.5	0.025	0.635	0.730	18.5	0.750	19.1	0.875	22.2	1.750	44
	.800 x 1	1-1/2	38.1	2-1/2	63.5	0.030	0.762	0.800	20.3	0.820	2.80	1.000	25.4	2.250	57
	1-1/4 1-1/2	Contact Customer Service for actual dimensions.													

** Minimum 36" length.

For detailed ordering information, please consult price list or contact Parflex® Division.

FEP Convoluted

Series SAE AS81914/3 and SAE AS81914/4

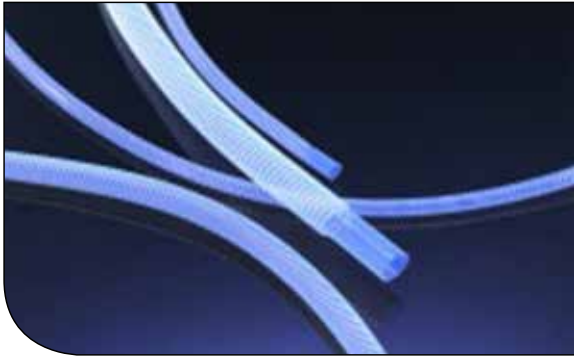

Features

- Longer lengths than PTFE
- Excellent clarity
- Chemically inert
- Low coefficient of friction
- Superior dielectric strength
- Good heat resistance
- Self extinguishing
- Non-wetting

Certifications

- SAE AS81914/3
- SAE AS81914/4
- ASTM D3296-03
- FDA Compliant
- USP Class VI Compliant
- VW-1, UL-83 (natural)

Applications/Markets



- Fluid Handling
- Harnesses
- Lab Equipment
- Robotics

Order Information

Example: 81914/3-1001-NT

81914/3-1001-NT – SAE AS81914 Convoluted

81914/3-1001-NT – **FEP**

81914/3-**1001**-NT – **Helical Convolutions**

81914/3-100**1**-NT – **Size (01=0.187")**

81914/3-1001-**NT** – **Color (N=Natural)**

81914/3-1001-**NT** – **"T" is bulk** (for cut tubing remove "T", add length, ie. 81914/3-1001-N1200 = 187" Convo, natural, cut 12" long)

Notes

- Working Temperature: 392°F (200°C)
- Tubing is provided in natural without cuffs direct from inventory
- Stock packaging is random coils
- Also available in close convolution 81914/4
- Minimum quantities may apply
- Custom packaging, sizes, lengths, cuffs and colors are quoted upon request

Colors

- ○ Natural, Translucent
- Colors available as custom run, see color code table

When ordering convoluted tubing in colors, the "N" designation for natural should be replaced by the correct color designator;

ie 81914/3-1001-0T (black bulk tubing)

ie 81914/3-1001-01200 (black tubing - 12 inches long)

Color Code					
○	N	Natural	●	5	Green
●	0	Black	●	6	Blue
●	1	Brown	●	7	Violet
●	2	Red	●	8	Gray
●	3	Orange	○	9	White
●	4	Yellow			

FEP Convuluted Tubing (SAE AS81914/3)

(Standard tubing is natural)

Part Number	MIL Spec	Maximum Inside Diameter		Minimum Inside Diameter		Maximum Outside Diameter		Maximum Wall Thickness		Minimum Bend Radius		Pitch ±1	Weight	
		inch	mm	inch	mm	inch	mm	inch	mm	inch	mm		lb./100 ft.	kg./100 mtr.
81914/3-1001-NT	-01	0.188	4.78	0.181	4.60	0.320	8.13	0.018	0.457	0.500	13	8	1.5	2.23
81914/3-1002-NT	-02	0.281	7.14	0.273	6.93	0.414	10.5	0.018	0.457	0.750	19	8	1.7	2.53
81914/3-1003-NT	-03	0.312	7.93	0.306	7.77	0.450	11.4	0.018	0.457	0.750	19	8	1.9	2.83
81914/3-1004-NT	-04	0.375	9.53	0.364	9.25	0.510	13.0	0.018	0.457	0.875	22	8	2.2	3.27
81914/3-1005-NT	-05	0.437	11.1	0.427	10.9	0.571	14.5	0.018	0.457	0.875	22	8	3.1	4.61
81914/3-1006-NT	-06	0.500	12.7	0.485	12.3	0.650	16.5	0.023	0.584	1.250	32	7	4.0	5.95
81914/3-1007-NT	-07	0.625	15.9	0.608	15.4	0.770	19.6	0.023	0.584	1.500	38	7	4.8	7.14
81914/3-1008-NT	-08	0.750	19.1	0.730	18.5	0.930	23.6	0.023	0.584	1.750	44	6	6.1	9.07
81914/3-1009-NT	-09	0.875	22.2	0.860	21.8	1.073	27.3	0.023	0.584	2.000	51	5	7.0	10.4
81914/3-1010-NT	-10	1.000	25.4	0.975	24.8	1.226	31.1	0.023	0.584	2.375	60	5	8.5	12.7
81914/3-1011-NT	-11	1.125	28.6	1.105	28.1	1.390	35.3	0.023	0.584	2.375	60	5	9.3	13.8
81914/3-1012-NT	-12	1.250	31.8	1.210	30.7	1.539	39.1	0.023	0.584	2.750	70	4	10.9	16.2
81914/3-1013-NT	-13	1.500	38.1	1.437	36.5	1.832	46.5	0.023	0.584	3.375	86	4	12.6	18.8
81914/3-1014-NT	-14	1.750	44.5	1.688	42.9	2.082	52.9	0.023	0.584	3.875	98	4	14.8	22.0
81914/3-1015-NT	-15	2.000	50.8	1.937	49.2	2.332	59.2	0.023	0.584	4.250	108	4	16.8	25.0

FEP convuluted tubing is provided in NATURAL without cuffs direct from the factory. Natural part numbers are designated with "NT" after the Mil Spec number (ie 81914/3-1014-NT).

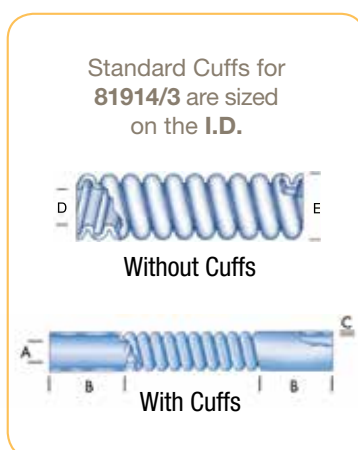

For detailed ordering information, please consult price list or contact Parflex® Division.

FEP/PFA Corrugated

Extra Flexible Fluoropolymer Tubing, Series CR03



Features

- Capable of turning sharp corners without reducing the inside diameter of the tube
- Extremely flexible
- Kink resistant
- Non stick surface allows for easy cleaning
- Excellent clarity
- Chemically inert
- Available in FEP, PFA and High Purity PFA

Certifications

- FEP - ASTM D3296-03
- PFA - ASTM D3307-10
- FDA Compliant
- USP Class VI Compliant
- VW-1, UL-83 (natural)

Applications/Markets



- Vacuum Applications
- Robotics
- Instrumentation
- DNA Sequencer
- Fluid Transfer
- Pharmaceutical
- Wet Bench

Order Information

Example: CR03-3/4-NT

CR03-3/4-NT – Corrugated Tubing

CR03-3/4-NT – FEP

CR03-3/4-NT – Tube I.D. when cuffed in inches (3/4")

CR03-3/4-NT – Color (N=Natural)

CR03-3/4-NT – "T" is bulk - for cuffed tubing add length, ie. CR03-3/4-N1200 = 1" Corr, natural, cut 12" long

Colors

- ○ Natural, Translucent

Notes

- Working Temperature: 200°F (93°C) @ 0 pressure - For higher temperatures, request PFA Corrugated 300°F (148°C) @ 0 pressure
- Vacuum Service: 29.9 IN. Hg (759M Hg)
- Extension-Compression Length Ratio: Approximately 2:1
- Tubing is provided in natural without cuffs direct from inventory or with cuffs, as requested at time of order
- Stock packaging is random coils
- Minimum quantities may apply
- Corrugated tubing is also available in specialty configurations where corrugated and straight tubing run intermittently along the tube
- Custom packaging, sizes, lengths and colors are quoted upon request

FEP Tex-Flex® Corrugated

Part Number	Size To Order	Maximum Cuff I.D. "A"		Standard Cuff Length "B"		Wall Thickness "C"		Ref. Outside Diameter "D"		Corrugated Length "E"	Minimum Bend Radius	
		inch	mm	inch	mm	inch	mm	inch	mm		±1	inch
CR03-1/4-NT	1/4	0.250	6.35	3/4	19.1	0.015	0.38	0.375	9.53	To be specified at time of order	0.125	3.18
CR03-3/8-NT	3/8	0.375	9.53	1	25.4	0.020	0.51	0.625	15.9		0.187	4.76
CR03-1/2-NT	1/2	0.500	12.7	1	25.4	0.025	0.64	0.750	19.0		0.250	6.35
CR03-5/8-NT	5/8	0.625	15.9	1	25.4	0.025	0.64	0.938	23.8		0.312	7.94
CR03-3/4-NT	3/4	0.750	19.1	1-1/2	38.1	0.030	0.76	1.063	26.9		0.375	9.53
CR03-7/8-NT	7/8	0.875	22.2	1-1/2	38.1	0.030	0.76	1.250	31.8		0.438	11.1
CR03-1.00-NT	1	1.000	24.8	2	50.8	0.035	0.89	1.438	36.5		0.500	12.7
CR03-1.25-NT	1-1/4	1.250	31.8	2	50.8	0.035	0.89	1.625	41.3		0.625	15.9
CR03-1.50-NT	1-1/2	1.500	38.1	2	50.8	0.035	0.89	1.813	46.1		0.750	19.1
CR03-2.00-NT	2	2.000	50.8	2	50.8	0.040	1.02	2.625	66.7		1.000	25.4
CR03-2.50-NT	2-1/2	2.5000	63.8	2-1/2	63.5	0.070	1.78	3.360	85.3		2.500	63.5

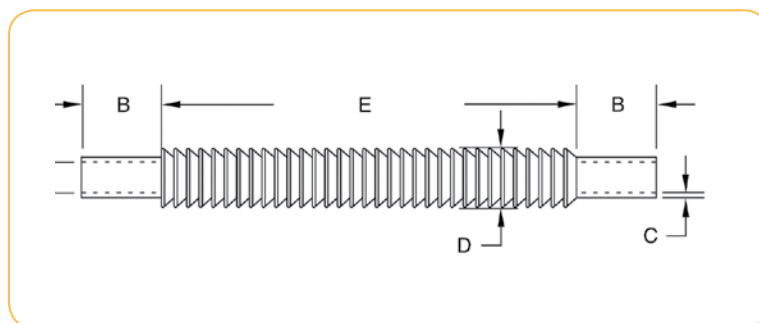

For detailed ordering information, please consult price list or contact Parflex® Division.



Retractable Coiled Tubing

Single or Dual Containment, Series 703, 704, 705

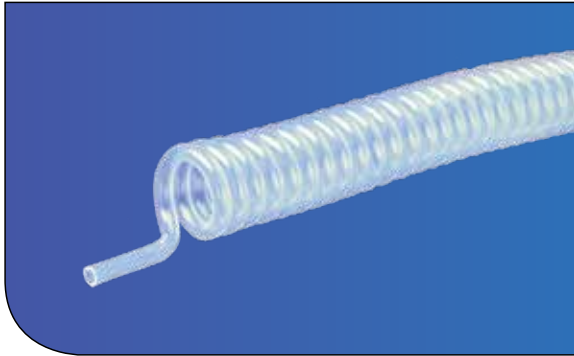

Features

- Extremely flexible
- Excellent clarity
- Chemically inert
- Low coefficient of friction
- Self extinguishing
- Non-wetting
- Available in FEP, PFA and High Purity PFA

Certifications

- FEP - ASTM D3296-03
- PFA - ASTM D3307-10
- FDA Compliant
- USP Class VI Compliant
- VW-1, UL-83 (natural)

Applications/Markets



- Fluid Handling
- Wet Bench
- Lab Equipment
- Gas Dispensing
- Medical

Order Information

Example: 704-0312062-xx0012

704-0312062-xx0012 – **Retractable tubing**

704-0312062-xx0012 – **PFA**

704-0312062-xx0012 – **Tube O.D. in inches (3/16")**

704-0312062-xx0012 – **Wall (0.062")**

704-0312062-xx0012 – **Custom Options** (when needed)

704-0312062-xx0012 – **Length 12"**

Fittings

Fittings available for sizes 3/16" up to 1/2"

Parker Fittings available from:
Fluid System Connectors Division
Otsego, MI

(269) 694-2550

(269) 692-6634 FAX

FSC Product Families:

- Compression
- Compress-Align®
- TrueSeal™

Colors

- ○ Natural, Translucent

Notes

- Working Temperature: 200°F (93°C) @ 0 pressure - For higher temperatures, request PFA 300°F (148°C) @ 0 pressure; above these temperatures, the coils dimensions are not stable and the coils will lose their shape
- "X" denotes resin type - Replace "X" with 3 for FEP, 4 for PFA and 5 for HP PFA
- "xx" denotes custom options - Use when needed
- Standard left/right tail length is 6 inches
- Minimum quantities may apply
- Custom packaging, sizes, lengths and colors are quoted upon request

Retractable Tubing

Part Number	Size To Order O.D. x Wall	Coil Inside Diameter		Retracted Length "A"		Extended Length	
		inch	mm	inch	mm	inch	mm
70X-0188062-xx0003	3/16" x 1/16"	0.750	19.1	3	76	12	305
70X-0188062-xx0006	3/16" x 1/16"	0.750	19.1	6	152	24	610
70X-0188062-xx0012	3/16" x 1/16"	0.750	19.1	12	305	48	1219
70X-0188062-xx0018	3/16" x 1/16"	0.750	19.1	18	457	72	1829
70X-0250062-xx0003	1/4" x 1/8"	1	25.4	3	76	12	305
70X-0250062-xx0006	1/4" x 1/8"	1	25.4	6	152	24	610
70X-0250062-xx0012	1/4" x 1/8"	1	25.4	12	305	48	1219
70X-0250062-xx0018	1/4" x 1/8"	1	25.4	18	457	72	1829
70X-0312062-xx0003	5/16" x 3/16"	1.625	41.3	3	76	12	305
70X-0312062-xx0006	5/16" x 3/16"	1.625	41.3	6	152	24	610
70X-0312062-xx0012	5/16" x 3/16"	1.625	41.3	12	305	48	1219
70X-0312062-xx0018	5/16" x 3/16"	1.625	41.3	18	457	72	1829
70X-0375062-xx0003	3/8" x 1/4"	1.625	41.3	3	76	12	305
70X-0375062-xx0006	3/8" x 1/4"	1.625	41.3	6	152	24	610
70X-0375062-xx0012	3/8" x 1/4"	1.625	41.3	12	305	48	1219
70X-0375062-xx0018	3/8" x 1/4"	1.625	41.3	18	457	72	1829
70X-0438062-xx0003	7/16" x 5/16"	3	76.2	3	76	12	305
70X-0438062-xx0006	7/16" x 5/16"	3	76.2	6	152	24	610
70X-0438062-xx0012	7/16" x 5/16"	3	76.2	12	305	48	1219
70X-0500062-xx0003	1/2" x 3/8"	3	76.2	3	76	12	305
70X-0500062-xx0006	1/2" x 3/8"	3	76.2	6	152	24	610
70X-0500062-xx0012	1/2" x 3/8"	3	76.2	12	305	48	1219

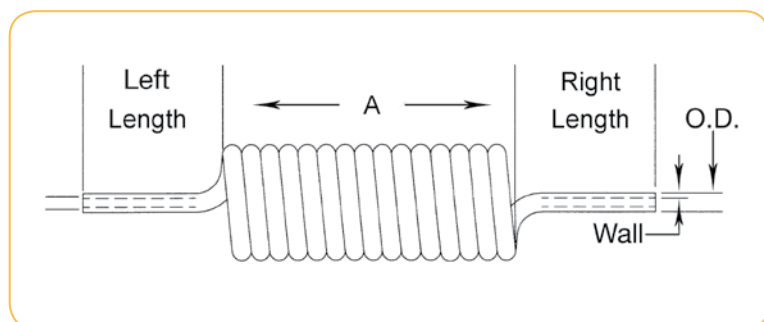

For detailed ordering information, please consult price list or contact Parflex® Division.

PFA Tubing

Series Fractional & Metric: 104, 204



Features

- Virgin Perfluoroalkoxy
- Translucent
- High purity resins available
- Low permeability
- Exceptional heat resistance
- Chemically inert
- Long continuous lengths
- Low coefficient of friction
- Self extinguishing
- Non-wetting
- Non leaching

Certifications/Compliance

- ASTM D3307-10
- VW-1, UL-83 (natural)
- FDA Compliant
- USP Class VI Compliant

Applications/Markets



- Air Sampling
- Gas Sampling
- Fluid Transfer
- Laboratory
- Wet Bench
- Flow Monitoring
- Steam Plant

Order Information

Example: 104-0188062-N-100

104-0188062-N-100 – **Fractional**

104-0188062-N-100 – **PFA**

104-**0188**062-N-100 – **Tube O.D.** in inches (**3/16"**)

104-0188**062**-N-100 – **Tube Wall Thickness** in inches (**.062"**)

104-0188062-**N**-100 – **Natural**

104-0188062-N-**100** – **Package Quantity** in feet (**100'**)

Fittings

Fittings available for sizes 3/32" up to 1"

Parker Fittings available from:
Fluid System Connectors Division
Otsego, MI

(269) 694-2550

(269) 692-6634 FAX

FSC Product Families:

- Compression
- Compress-Align®
- TrueSeal™

Notes

- Working Temperature:
-100°F to 500°F (-75°C to 260°C)
- Working pressure calculated using a Design Factor of 4 at 73°F (23°C)
- Custom packaging and sizes are quoted upon request
- Package quantities are not continuous

Options

- Smoothbore
- Convoluted
- Corrugated
- Retractable Coils
- Heat Shrink

Colors

- ○ Natural, Translucent
- Colors available as custom run, see color code table

Color Code					
○	N	Natural	●	5	Green
●	0	Black	●	6	Blue
●	1	Brown	●	7	Violet
●	2	Red	●	8	Gray
●	3	Orange	○	9	White
●	4	Yellow			

104 PFA Industrial Wall Fractional Size Tubing

Part Number	Order Size	Nominal O.D.				Nominal I.D.				Reference Wall		Working Pressure		Burst Pressure		Min. Bend Radius		Vac. Rating	Weight	
		inch	mm	tol.	mm	tol.	inch	mm	tol.	inch	mm	psi 73°F	bar 23°C	psi 73°F	bar 23°C	inch	mm		at 73°F	lb. per ft.
#																				
104-0094031	3/32	0.094	±0.004	2.40	±0.102	0.031	±0.002	0.79	±0.051	0.031	0.79	680	47	2720	188	0.250	6	28	0.006	0.009
104-0125031	1/8	0.125	±0.004	3.18	±0.102	0.064	±0.004	1.63	±0.102	0.031	0.79	500	34	2000	138	0.375	10	28	0.009	0.013
104-0156031	5/32	0.157	±0.005	3.99	±0.127	0.094	±0.003	2.39	±0.076	0.031	0.79	390	27	1560	108	0.625	16	28	0.011	0.017
104-0188031	3/16	0.188	±0.005	4.78	±0.127	0.125	±0.005	3.18	±0.127	0.031	0.79	320	22	1280	88	0.625	16	28	0.014	0.021
104-0250031	1/4	0.250	±0.005	6.35	±0.127	0.188	±0.005	4.78	±0.127	0.031	0.79	230	16	920	63	0.875	22	28	0.020	0.030
104-0312031	5/16	0.312	±0.005	7.92	±0.127	0.250	±0.005	6.35	±0.127	0.031	0.79	180	12	720	50	1.750	44	28	0.025	0.038
104-0375031	3/8	0.375	±0.005	9.52	±0.127	0.312	±0.005	7.92	±0.127	0.031	0.79	140	10	560	39	3.250	83	28	0.031	0.047
104-0438031	7/16	0.438	±0.005	11.13	±0.127	0.375	±0.005	9.53	±0.127	0.031	0.79	120	8	480	33	3.250	83	28	0.037	0.055
104-0500031	1/2	0.500	±0.005	12.70	±0.127	0.438	±0.005	11.13	±0.127	0.031	0.79	100	7	400	28	4.750	121	28	0.043	0.063
104-0563031	9/16	0.563	±0.006	14.30	±0.152	0.500	±0.006	12.70	±0.152	0.031	0.79	80	6	320	22	5.000	127	28	0.048	0.072

104 PFA Heavy Wall Fractional Size Tubing

Part Number	Order Size	Nominal O.D.				Nominal I.D.				Reference Wall		Working Pressure		Burst Pressure		Min. Bend Radius		Vac. Rating	Weight	
		inch	mm	tol.	mm	tol.	inch	mm	tol.	inch	mm	psi 73°F	bar 23°C	psi 73°F	bar 23°C	inch	mm		at 73°F	lb. per ft.
#																				
104-0188062	3/16	0.188	±0.005	4.78	±0.127	0.062	±0.005	1.57	±0.127	0.062	1.57	680	47	2720	188	0.500	13	28	0.023	0.034
104-0250040	1/4	0.250	±0.005	6.35	±0.127	0.170	±0.005	4.32	±0.127	0.040	1.02	300	21	1200	83	0.875	22	28	0.025	0.037
104-0250047	1/4	0.250	±0.005	6.35	±0.127	0.156	±0.005	3.96	±0.127	0.047	1.19	370	26	1480	102	1.000	25	28	0.028	0.042
104-0250062	1/4	0.250	±0.005	6.35	±0.127	0.125	±0.005	3.18	±0.127	0.062	1.57	500	34	2000	138	0.500	13	28	0.034	0.051
104-0312062	5/16	0.312	±0.005	7.92	±0.127	0.188	±0.005	4.78	±0.127	0.062	1.57	390	27	1560	108	0.750	19	28	0.045	0.068
104-0375062	3/8	0.375	±0.005	9.52	±0.127	0.250	±0.005	6.35	±0.127	0.062	1.57	320	22	1280	88	1.250	32	28	0.057	0.085
104-0438062	7/16	0.438	±0.005	11.13	±0.127	0.312	±0.005	7.92	±0.127	0.062	1.57	270	19	1080	74	2.625	67	28	0.068	0.102
104-0500062	1/2	0.500	±0.005	12.70	±0.127	0.375	±0.005	9.53	±0.127	0.062	1.57	230	16	920	63	3.000	76	28	0.079	0.119
104-0750062	3/4	0.750	±0.006	19.05	±0.152	0.625	±0.006	15.88	±0.152	0.062	1.57	140	10	560	39	6.000	152	28	0.125	0.186
104-1000062	1	1.000	±0.010	25.40	±0.254	0.875	±0.010	22.22	±0.254	0.062	1.57	100	7	400	28	8.000	203	28	0.170	0.254

204 Metric PFA Tubing

Part Number	Order Size	Nominal O.D.				Nominal I.D.				Reference Wall		Working Pressure		Burst Pressure		Min. Bend Radius		Vac. Rating	Weight	
		mm	mm	tol.	inch	tol.	mm	tol.	inch	tol.	mm	inch	bar 23°C	psi 73°F	bar 23°C	psi 73°F	mm		inch	at 73°F
#																				
204-0400100	4	4	±0.11	.157	±0.004	2	±0.11	.079	±0.250	1	0.039	34	500	138	2000	6	0.250	28	0.020	0.014
204-0600100	6	6	±0.11	.236	±0.004	4	±0.11	.157	±0.004	1	0.039	22	320	88	1280	25	1.000	28	0.034	0.023
204-0800100	8	8	±0.11	.315	±0.004	6	±0.11	.236	±0.004	1	0.039	16	230	63	920	51	2.000	28	0.047	0.032
204-1000100	10	10	±0.11	.393	±0.004	8	±0.11	.315	±0.004	1	0.039	12	180	50	720	70	2.750	28	0.061	0.041
204-1200100	12	12	±0.15	.472	±0.006	10	±0.15	.393	±0.006	1	0.039	10	140	39	560	89	3.500	28	0.074	0.050

For detailed ordering information, please consult price list or contact Parflex® Division.



A Hose

B Tubing
Fluoropolymer

C Coiled Air Hose
& Fittings

D Transportation

E Fittings

F Tooling, Equipment
& Accessories

G General Technical

High Purity PFA Tubing

Series Fractional & Metric: 105, 205

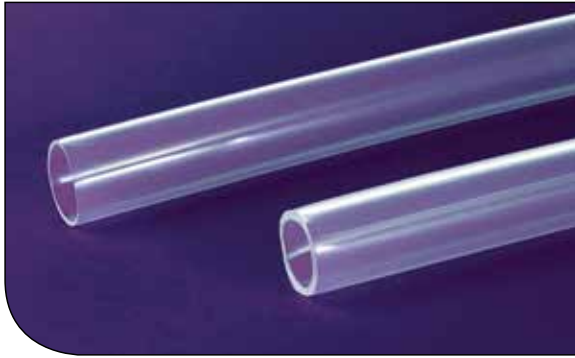

Features

- Withstands corrosive surfactants for longer periods of time
- Highest molecular weight available
- Lowest level of extractables
- Low permeability
- Exceptional heat resistance
- Chemically inert
- Long continuous lengths
- Low coefficient of friction
- Self extinguishing
- Non leaching

Certifications/Compliance

- ASTM D3307-10
- VW-1, UL-83 (natural)
- FDA Compliant
- USP Class VI Compliant

Applications/Markets



- Flow Monitoring
- Gas Transfer
- Food
- Wet Bench
- DI Water Dispensers
- DI Recirculators
- Heat Exchangers
- Pure Chemical Dispensers
- High Purity Applications

Order Information

Example: 105-0375031-N-100

105-0375031-N-100 – **Fractional**

105-0375031-N-100 – **High Purity PFA**

105-**0375031**-N-100 – **Tube O.D.** in millimeters (**3/8"**)

105-0375**031**-N-100 – **Tube Wall Thickness** in millimeters (**.031"**)

105-0375031-**N**-100 – **Natural**

105-0375031-N-**100** – **Package Quantity** in feet (**100'**)

Fittings

Fittings available for sizes 4mm up to 12mm

Parker Fittings available from:
Fluid System Connectors Division
Otsego, MI

(269) 694-2550

(269) 692-6634 FAX

FSC Product Families:

- Compression
- Compress-Align®
- TrueSeal™

Notes

- Working Temperature:
-100°F to 500°F (-75°C to 260°C)
- Working pressure calculated using a Design Factor of 4 at 73°F (23°C)
- Custom packaging and sizes are quoted upon request
- Package quantities are not continuous

Options

- Smoothbore
- Convoluted
- Corrugated
- Retractable Coils

Colors

- Natural, Translucent

105 High Purity PFA Industrial Wall Fractional Size Tubing

Part Number	Order Size	Nominal O.D.				Nominal I.D.				Reference Wall		Working Pressure		Burst Pressure		Min. Bend Radius		Vac. Rating	Weight	
		inch	inch	tol.	mm	tol.	inch	tol.	mm	tol.	inch	mm	psi 73°F	bar 23°C	psi 73°F	bar 23°C	inch		mm	at 73°F
#																				
105-0125031	1/8	0.125	± 0.004	3.18	± 0.102	0.064	± 0.004	1.63	± 0.102	0.031	0.79	500	34	2000	138	0.500	13	28	0.009	0.013
105-0188031	3/16	0.188	± 0.005	4.78	± 0.127	0.125	± 0.005	3.18	± 0.127	0.031	0.79	320	22	1280	88	0.750	19	28	0.014	0.021
105-0250031	1/4	0.250	± 0.005	6.35	± 0.127	0.188	± 0.005	4.78	± 0.127	0.031	0.79	230	16	920	63	1.000	25	28	0.020	0.030
105-0375031	3/8	0.375	± 0.005	9.52	± 0.127	0.312	± 0.005	7.92	± 0.127	0.031	0.79	140	10	560	39	3.500	89	28	0.031	0.047

105 High Purity PFA Heavy Wall Fractional Size Tubing

Part Number	Order Size	Nominal O.D.				Nominal I.D.				Reference Wall		Working Pressure		Burst Pressure		Min. Bend Radius		Vac. Rating	Weight	
		inch	inch	tol.	mm	tol.	inch	tol.	mm	tol.	inch	mm	psi 73°F	bar 23°C	psi 73°F	bar 23°C	inch		mm	at 73°F
#																				
105-0250040	1/4	0.250	± 0.005	6.35	± 0.127	0.170	± 0.005	4.32	± 0.127	0.040	1.02	300	21	1200	83	0.938	24	28	0.025	0.037
105-0250047	1/4	0.250	± 0.005	6.35	± 0.127	0.156	± 0.005	3.96	± 0.127	0.047	1.19	370	26	1480	102	0.500	13	28	0.028	0.042
105-0250062	1/4	0.250	± 0.005	6.35	± 0.127	0.125	± 0.005	3.18	± 0.127	0.062	1.57	500	34	2000	138	0.625	16	28	0.034	0.051
105-0375062	3/8	0.375	± 0.005	9.52	± 0.127	0.250	± 0.005	6.35	± 0.127	0.062	1.57	320	22	1280	88	1.125	29	28	0.057	0.085
105-0500062	1/2	0.500	± 0.005	12.70	± 0.127	0.375	± 0.005	9.53	± 0.127	0.062	1.57	230	16	920	63	2.250	57	28	0.079	0.119
105-0750062	3/4	0.750	± 0.006	19.05	± 0.152	0.625	± 0.006	15.88	± 0.152	0.062	1.57	140	10	560	39	4.250	108	28	0.125	0.186
105-1000062	1	1.000	± 0.010	25.40	± 0.254	0.875	± 0.010	22.22	± 0.254	0.062	1.57	100	7	400	28	8.000	203	*	0.170	0.254

205 Metric High PFA Tubing

Part Number	Order Size	Nominal O.D.				Nominal I.D.				Reference Wall		Working Pressure		Burst Pressure		Min. Bend Radius		Vac. Rating	Weight	
		mm	mm	tol.	inch	tol.	mm	tol.	inch	tol.	mm	inch	bar 23°C	psi 73°F	bar 23°C	psi 73°F	mm		inch	at 73°F
#																				
205-0300100	3	3	± 0.11	0.118	± 0.004	1	± 0.11	0.039	± 0.004	1	0.039	47	680	188	2720	13	0.500	28	0.014	0.009
205-0400100	4	4	± 0.11	0.157	± 0.004	2	± 0.11	0.079	± 0.004	1	0.039	34	500	138	2000	13	0.500	28	0.020	0.020
205-0600100	6	6	± 0.11	0.236	± 0.004	4	± 0.11	0.157	± 0.004	1	0.039	22	320	88	1280	22	0.875	28	0.034	0.023
205-0800100	8	8	± 0.11	0.315	± 0.004	6	± 0.11	0.236	± 0.004	1	0.039	16	230	63	920	35	1.375	28	0.047	0.032
205-1000100	10	10	± 0.11	0.393	± 0.004	8	± 0.11	0.315	± 0.004	1	0.039	12	180	50	720	51	2.000	28	0.061	0.041
205-1200100	12	12	± 0.15	0.472	± 0.006	10	± 0.15	0.394	± 0.006	1	0.039	10	140	39	560	89	3.500	28	0.074	0.050

For detailed ordering information, please consult price list or contact Parflex® Division.



PVDF Tubing Polyvinylidene Fluoride

Series PVDF Flex™: 110, Series PVDF Super-Flex™: 111



Features

- Low extractable levels
- High mechanical strength
- Good chemical resistance
- High abrasion resistance
- Exceptional thermal stability
- Low permeability
- Self extinguishing
- Weather resistant

Certifications

- ASTM D3222
- FDA Compliant

Applications/Markets



- Applications with long cycle life
- Gas
- Food
- Thermal cycling
- Outdoor/extreme conditions
- Water systems
- Ground water monitoring
- Fluid and handling

Order Information

Example: 110-0312062-NT-100

110-0312062-NT-100 – **PVDF Flex**

110-0312062-NT-100 – **Tube O.D.** in inches (5/16")

110-0312062-NT-100 – **Tube Wall Thickness** in inches (.062")

110-0312062-NT-100 – **Natural**

110-0312062-NT-100 – **Bulk Tubing**

110-0312062-NT-100 – **Package Quantity** in feet (100')

Notes

- Working Temperature: -80°F to 265°F (-62°C to 130°C)
- Working pressure calculated using a Design Factor of 4 at 73°F (23°C)
- Custom packaging and sizes are quoted upon request

Colors

- ○ Off-white

Fittings

Fittings available for sizes 1/8" up to 1"

Parker Fittings available from:
Fluid System Connectors Division
Otsego, MI

(269) 694-2550

(269) 692-6634 FAX

FSC Product Families:

- Compression
- Compress-Align®
- TrueSeal™

Color Code

○	N	Natural	●	5	Green
●	0	Black	●	6	Blue
●	1	Brown	●	7	Violet
●	2	Red	●	8	Gray
●	3	Orange	○	9	White
●	4	Yellow			

110 PVDF Flex™ Industrial Wall Fractional Size Tubing

Part Number	Order Size	Nominal O.D.				Nominal I.D.				Reference Wall		Working Pressure		Burst Pressure		Min. Bend Radius		Vac. Rating	Weight	
		inch	inch	tol.	mm	tol.	inch	tol.	mm	tol.	inch	mm	psi 73°F	bar 23°C	psi 73°F	bar 23°C	inch		mm	at 73°F
#																				
110-0125031	1/8	0.125	±0.005	3.18	±0.13	0.062	±0.005	1.57	±0.13	0.031	0.79	267	18.4	1068	73.6	0.500	13	28	0.007	0.011
110-0188031	3/16	0.188	±0.005	4.78	±0.13	0.125	±0.005	3.18	±0.13	0.031	0.79	180	12.4	720	49.6	0.750	19	28	0.012	0.018
110-0250031	1/4	0.250	±0.005	6.35	±0.13	0.188	±0.005	4.78	±0.13	0.031	0.79	170	11.7	680	46.8	1.000	25	28	0.016	0.025
110-0375031	3/8	0.375	±0.005	9.52	±0.13	0.312	±0.005	7.92	±0.13	0.031	0.79	93	6.4	372	25.6	2.500	64	28	0.026	0.039
110-0500031	1/2	0.500	±0.005	12.70	±0.13	0.438	±0.005	11.13	±0.13	0.031	0.79	83	5.7	332	22.9	4.000	102	28	0.035	0.053

110 PVDF Flex™ Heavy Wall Fractional Size Tubing

Part Number	Order Size	Nominal O.D.				Nominal I.D.				Reference Wall		Working Pressure		Burst Pressure		Min. Bend Radius		Vac. Rating	Weight	
		inch	inch	tol.	mm	tol.	inch	tol.	mm	tol.	inch	mm	psi 73°F	bar 23°C	psi 73°F	bar 23°C	inch		mm	at 73°F
#																				
110-0250047	1/4	0.250	±0.005	6.35	±0.13	0.156	±0.005	3.96	±0.13	.047	1.19	208	14.3	832	57.4	0.750	19	28	0.023	0.034
110-0250062	1/4	0.250	±0.005	6.35	±0.13	0.125	±0.005	3.18	±0.13	.062	1.57	330	22.8	1320	91.0	0.500	13	28	0.028	0.042
110-0312062	5/16	0.312	±0.005	7.92	±0.13	0.188	±0.005	4.78	±0.13	.062	1.57	219	15.1	876	60.4	0.875	22	28	0.038	0.056
110-0375062	3/8	0.375	±0.005	9.52	±0.13	0.250	±0.005	6.35	±0.13	.062	1.57	224	15.4	896	61.8	1.000	25	28	0.047	0.070
110-0500062	1/2	0.500	±0.005	12.70	±0.13	0.370	±0.005	9.40	±0.13	.062	1.57	169	11.7	676	46.6	2.000	51	28	0.066	0.098
110-0625062	5/8	0.625	±0.005	15.88	±0.13	0.500	±0.005	12.70	±0.13	.062	1.57	136	9.3	544	37.5	3.000	76	28	0.085	0.126
110-0750062	3/4	0.750	±0.006	19.05	±0.15	0.625	±0.006	15.88	±0.15	.062	1.57	114	7.9	456	31.4	6.000	152	28	0.103	0.154
110-1000062	1	1.000	±0.010	25.40	±0.25	0.875	±0.008	22.22	±0.25	.062	1.57	86	5.9	344	23.7	8.000	203	28	0.141	0.210

111 PVDF Super-Flex™ Industrial Wall Fractional Size Tubing

Part Number	Order Size	Nominal O.D.				Nominal I.D.				Reference Wall		Working Pressure		Burst Pressure		Min. Bend Radius		Vac. Rating	Weight	
		inch	inch	tol.	mm	tol.	inch	tol.	mm	tol.	inch	mm	psi 73°F	bar 23°C	psi 73°F	bar 23°C	inch		mm	at 73°F
#																				
111-0188031	3/16	0.188	±0.005	4.78	±0.13	0.125	±0.005	3.18	±0.13	0.031	0.79	180	12.4	720	50	0.750	19	28	0.012	0.018
111-0250031	1/4	0.250	±0.005	6.35	±0.13	0.188	±0.005	4.78	±0.13	0.031	0.79	170	11.7	680	47	0.750	19	28	0.016	0.025
111-0375031	3/8	0.375	±0.005	9.53	±0.13	0.312	±0.005	7.92	±0.13	0.031	0.79	93	6.4	372	26	2.500	64	28	0.026	0.039

111 PVDF Super-Flex™ Heavy Wall Fractional Size Tubing

Part Number	Order Size	Nominal O.D.				Nominal I.D.				Reference Wall		Working Pressure		Burst Pressure		Min. Bend Radius		Vac. Rating	Weight	
		inch	inch	tol.	mm	tol.	inch	tol.	mm	tol.	inch	mm	psi 73°F	bar 23°C	psi 73°F	bar 23°C	inch		mm	at 73°F
#																				
111-0250062	1/4	0.250	±0.005	6.35	±0.13	0.125	±0.005	3.18	±0.13	0.062	1.57	330	22.8	1320	91	0.375	10	28	0.028	0.042
111-0375062	3/8	0.375	±0.005	9.52	±0.13	0.250	±0.005	6.35	±0.13	0.062	1.57	224	15.4	896	62	0.750	19	28	0.038	0.056
111-0500062	1/2	0.500	±0.005	12.7	±0.13	0.375	±0.005	9.52	±0.13	0.062	1.57	169	11.7	676	47	1.500	38	28	0.066	0.098

For detailed ordering information, please consult price list or contact Parflex® Division.



