

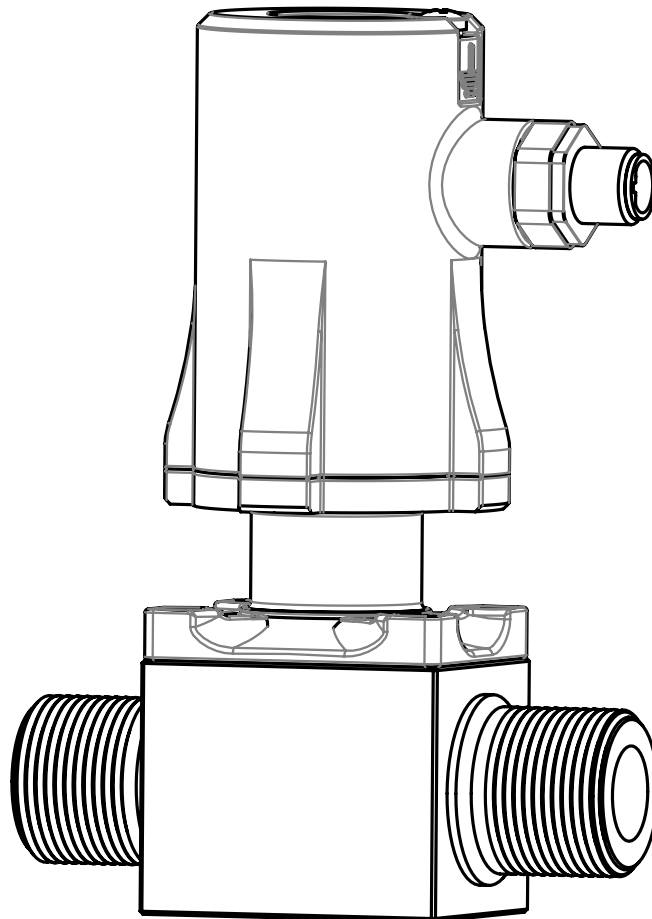

ISOMAG 

The friendly magmeter

**OPERATING AND MAINTENANCE
MANUAL**



CS3900

CE

ISOIL 
INDUSTRIA

Release number: **3900_IT_EN_R1_1_0X**

The characters of file name in bold type indicate the software version which the manual refers to; it is visualized at the instrument start up, or by specific function on DIAGNOSTIC menu.



INDEX

INTRODUCTION	1
SAFETY INFORMATION	1
SAFETY CONVENTION	2
TECHNICAL CHARACTERISTICS	3
ENVIRONMENTAL USE CONDITIONS	3
DATA PLATE	3
OVERALL DIMENSIONS	4
FLOW DIRECTION	6
SHREWDNESS AND PRECAUTIONS	7
ELECTRICAL CONNECTIONS	8
VERSION WITH CABLE	8
VERSION WITH CONNECTOR	8
GROUNDING CONNECTION	9
POWER SUPPLY	9
ON/OFF OUPUTS	10
OUTPUT 4÷20MA	10
USER INTERFACE	11
SIGNIFICATO DEI FLAGS	12
FLOW RATE VISUALIZATION	14
FLOW RATE ALERT	14
QUICK START MENU	14
ACCESS CODE SET : MENU 13 SYSTEM	15
RESTRICTED ACCESS SET : MENU 13 SYSTEM	15
CONVERTER ACCESS CODE	15
PROGRAMMING FUNCTIONS	18
FUNCTIONS DESCRIPTION	21
MENU 1 - SENSOR	22
MENU 2 - UNITS	24
MENU 3 - SCALE	26
MENU 4 - MEASURE	28
MENU 5 - ALARMS	30

MENU 7 - OUTPUTS	31
MENU 9 - DISPLAY	33
MENU 11 - FUNCTION	34
MENU 12 - DIAGNOSTIC	35
MENU 13 - SYSTEM	38
MENU 15 - PROCESS DATA (ONLY MCP)	43
ALARM MESSAGES (CAUSES AND ACTIONS TO BE TAKEN)	45
ERROR CODE TEST SYSTEM OF SENSOR	46
MANUAL REVIEWS	48

INTRODUCTION

- These operating instructions and description of device functions are provided as part of the scope of supply.
- They could be modified without prior notice. The improper use, possible tampering of the instrument or parts of it and substitutions of any components not original, renders the warranty automatically void.
- The flow meter realizes a measure with liquids of conductivity greater than $5\mu\text{S}/\text{cm}$ in closed conduits.

SAFETY INFORMATION

Any use other than described in this manual affects the protection provided by the manufacturer and compromises the safety of people and the entire measuring system and is, therefore, not permitted. The manufacturer is not liable for damaged caused by improper or non-designated use.

- ❑ Transport the measuring device to the measuring point in the original packaging. Do not remove covers or caps until immediately before installation. In case of cartons packaging it is possible to place one above the other but no more than three cartons. In case of wooden packaging do not place one above the other.
- ❑ Disposal of this product or parts of it must be carried out according to the local public or private waste collection service regulations.
- ❑ The converter must only be installed, connected and maintained by qualified and authorized specialists (e.g. electrical technicians) in full compliance with the instructions in this Operating Instruction, the applicable norms, legal regulations and certificates (depending on the application). The specialists must have read and understood these Operating Instructions and must follow the instructions it contains. The Operating Instructions provide detailed information about the device. If you are unclear on anything in these Operating Instructions, you must call the ISOIL service department.
- ❑ The converter should only be installed after have verified technical data provided in these operating instructions and on the data plate.
- ❑ Specialists must take care during installation and use personal protective equipment as provided by any related security plan or risk assessment.
- ❑ Never mount or wire the converter while it is connected to the power supply and avoid any liquid contact with the instrument's internal components. To connect remove the terminals from the terminal block.
- ❑ Before connecting the power supply check the functionality of the safety equipment.
- ❑ Repairs may only be performed if a genuine spare parts kit is available and this repair work is expressly permitted.
- ❑ For the cleaning of the device use only a damp cloth, and for the maintenance/repairs contact the service center (for details see the last page).





Before starting up the equipment please verify the following:

- ❑ Power supply voltage must correspond to that specified on the data plate
- ❑ Electric connections must be completed as described
- ❑ Ground (earth) connections must be completed as specified

Verify periodically (every 3-4 months):

- ❑ The power supply cables integrity, wiring and other connected electrical parts
- ❑ The converter housing integrity
- ❑ The suitable tightness of the sealing elements
- ❑ The mechanical fixing of the converter to the pipe or wall stand

SAFETY CONVENTION

 DANGER ELECTRIC SHOCK	 WARNING	 PRECAUTIONS	 ATTENTION
---	--	---	--

TECHNICAL CHARACTERISTICS



Instrument classification: class I, IP67, installation category II, rated pollution degree 2.

Power supply version	Power supply voltage	Pmax
LLV	10-30 $\overline{=}$	1W

- Voltage variations must not exceed $\pm 10\%$ of the nominal one.
- Output insulated up to 500V.
- The output 4-20mA max load: 500 Ω (optional) is electrically connected to the ON/OFF outputs and the output power supply (24V $\overline{=}$).

ENVIRONMENTAL USE CONDITIONS



- The instrument can be installed inside or outside buildings
- Altitude: from -200m to 2000m (from -656 to 6560 feet)
- Humidity range: 0-100% (IP 67)

ENVIRONMENTAL TEMPERATURE		
	MIN. *	MAX.
C°	-10	60
F°	14	140

LIQUID TEMPERATURE		
	MIN. *	MAX.
C°	-10	100
F°	14	210

* For discontinuous use, a thermostat heat source installation may be necessary.

DATA PLATE

On the data plate there is some technical information:

- MODEL:** Instrument Model
- S/N:** Instrument Serial Number
- DN:** Nominal diameter
- PN:** Nominal pressure
- FITT.:** process connections
- P.S.:** Power Supply
- Pow:** Maximum power consumption
- Tm/M:** Minimum and Maximum liquid temperature
- IP:** Protection grade
- Y:** Year
- ITEM:** free for user

ISOIL	
INDUSTRIA S.p.A. <small>Cristallo B. (MI) - ITALY www.isoil.com</small>	
MOD.	SensModel
S/N	SensMatricola
DN	SensDn
PN	SensPn
FITT.	SensFitt
P.S.	10-30 VDC
Pow.	1 W
Tm/M	-10/+100 °C
IP	67 Y Year
ITEM	Item

FLOW DIRECTION

OVERALL DIMENSIONS

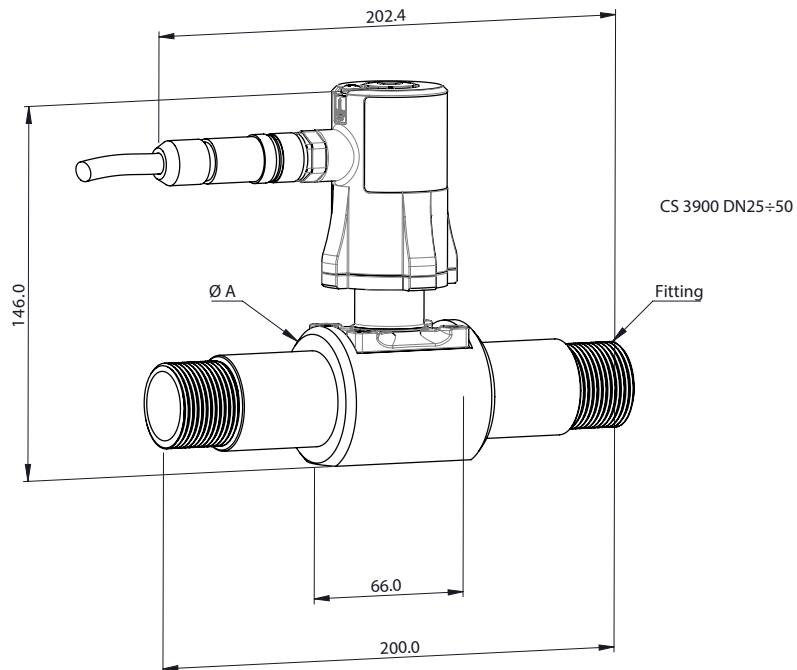
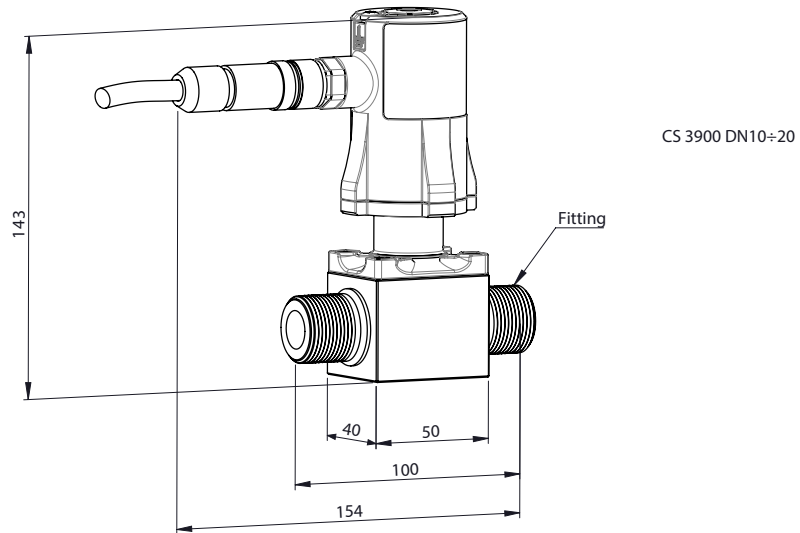

DN	FITTINGS	A	H
10	1/2"	---	---
15	3/4"	---	---
20	1"	---	---
25	1"	56	148
32	1"1/4	56	148
40	1"1/2	62	156
50	2"	69	164

The manufacturer guarantees only English text available on our web site www.isoil.com

PG7 for IF23 plug

Ground connection

5 poles plug
(phoenix contact SACC-FS-5SC SH SCO)

M4 screws

O-Ring 4106 (26.58X3.53)

Lined body

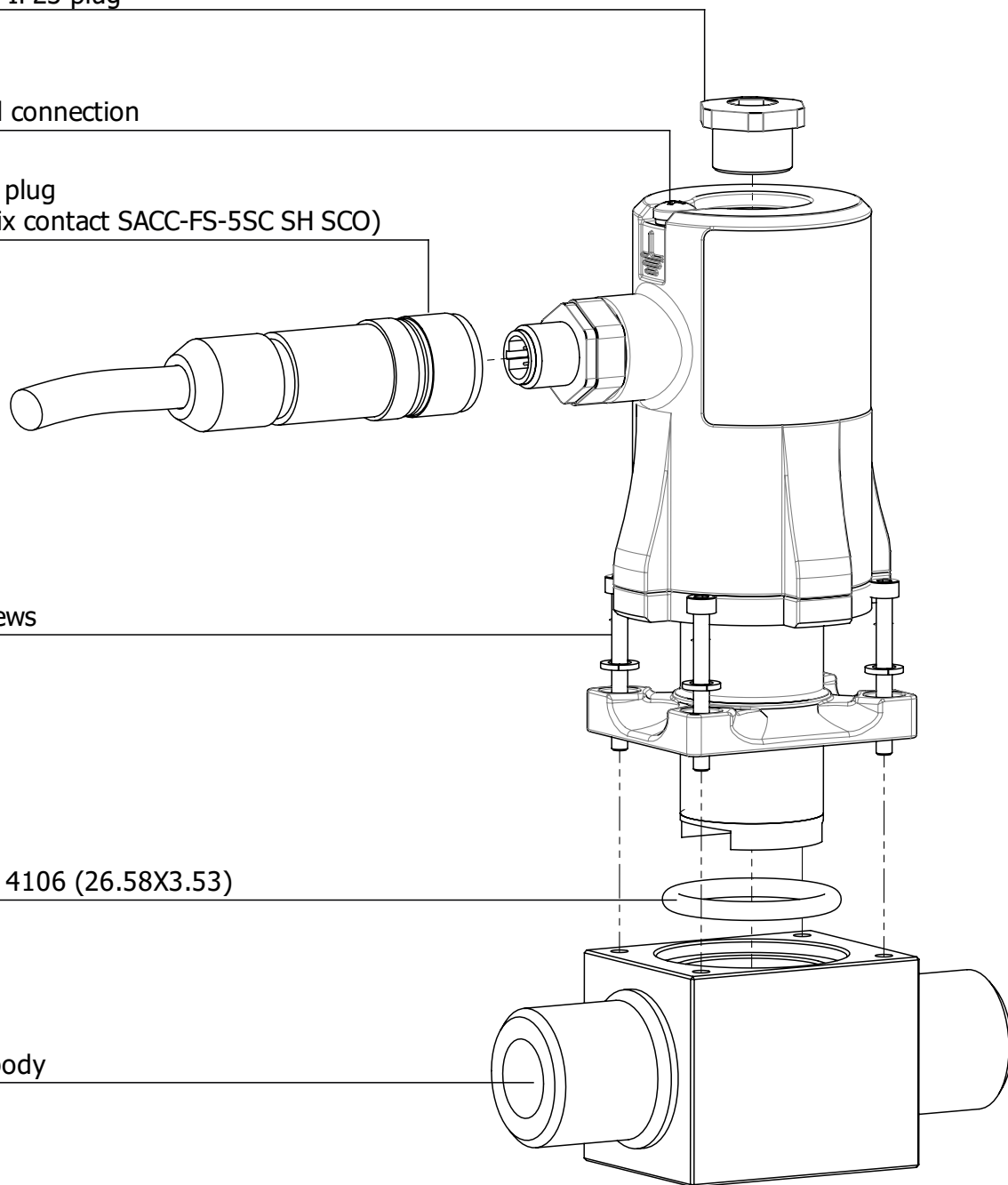

TORQUES	
PG9 plug	4Nm
5 poles conn./ cablegland PG9	4Nm
M4 screws	3Nm

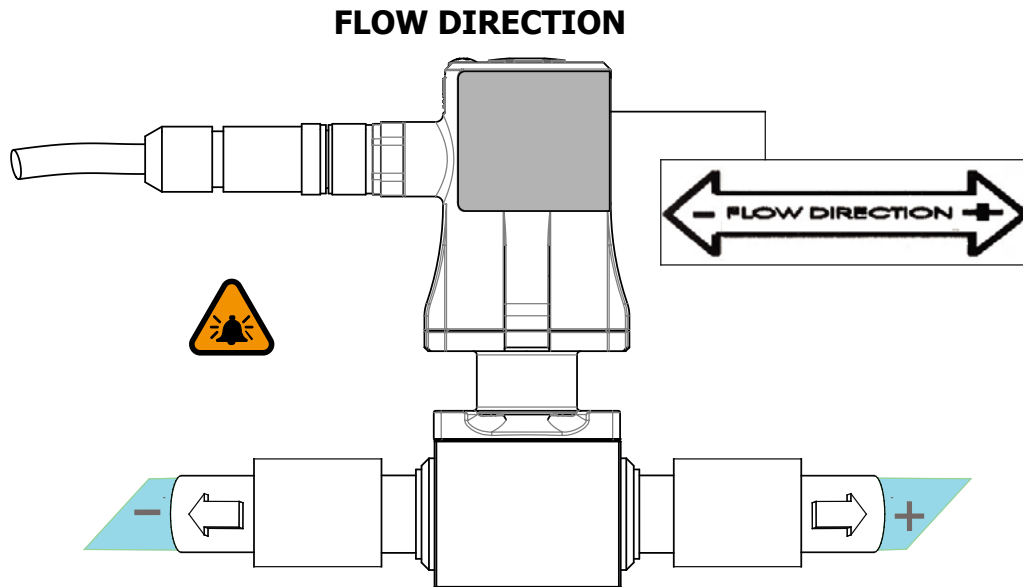

Before install the sensor locate the direction of the liquid in the piping

The sign of the flow rate is positive, when the flow direction it's from - to + as printed on the tag plate. If after the installation, for plant request becomes necessary reverse the sign of the flow, it's enough reverse the sign of the coefficient KA.

SHREWDNESS AND PRECAUTIONS

In vertical installations an ascending flow is preferable. For vertical installations with descending flow direction contact the manufacturer

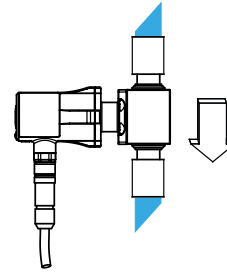
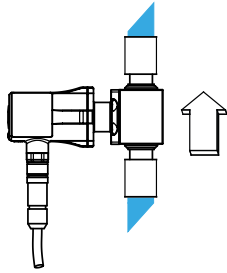

Avoid a partially empty pipe, during operation the pipe must be either completely full of liquid or completely empty

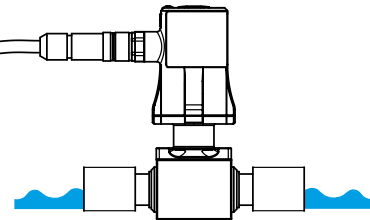
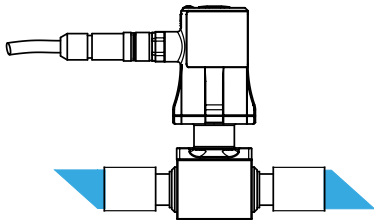

Install the sensor away from bends and hydraulic accessories (see the tabe in the previous page)

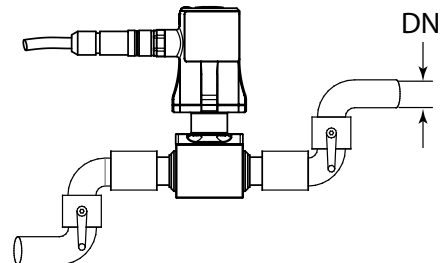
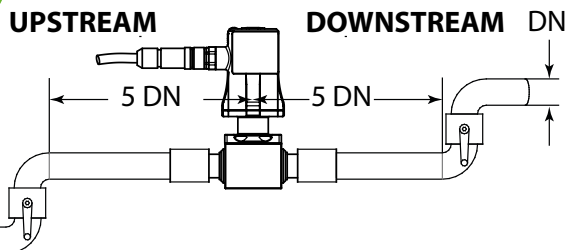

The manufacturer guarantees only English text available on our web site www.isomag.com

ELECTRICAL CONNECTIONS VERSION WITH CABLE

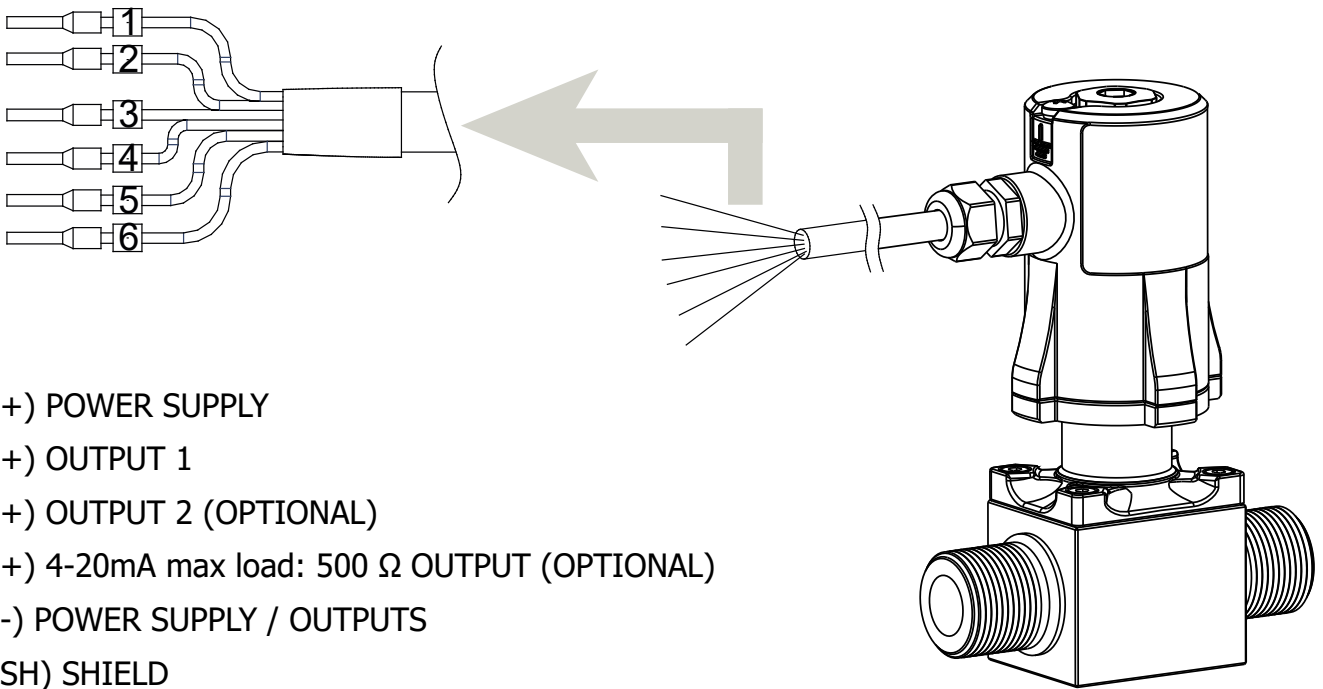

- 1 (+) POWER SUPPLY
- 2 (+) OUTPUT 1
- 3 (+) OUTPUT 2 (OPTIONAL)
- 4 (+) 4-20mA max load: 500 Ω OUTPUT (OPTIONAL)
- 5 (-) POWER SUPPLY / OUTPUTS
- 6 (SH) SHIELD

 **PIN 5/6 TO BE CONNECT TO THE GROUND**

VERSION WITH CONNECTOR

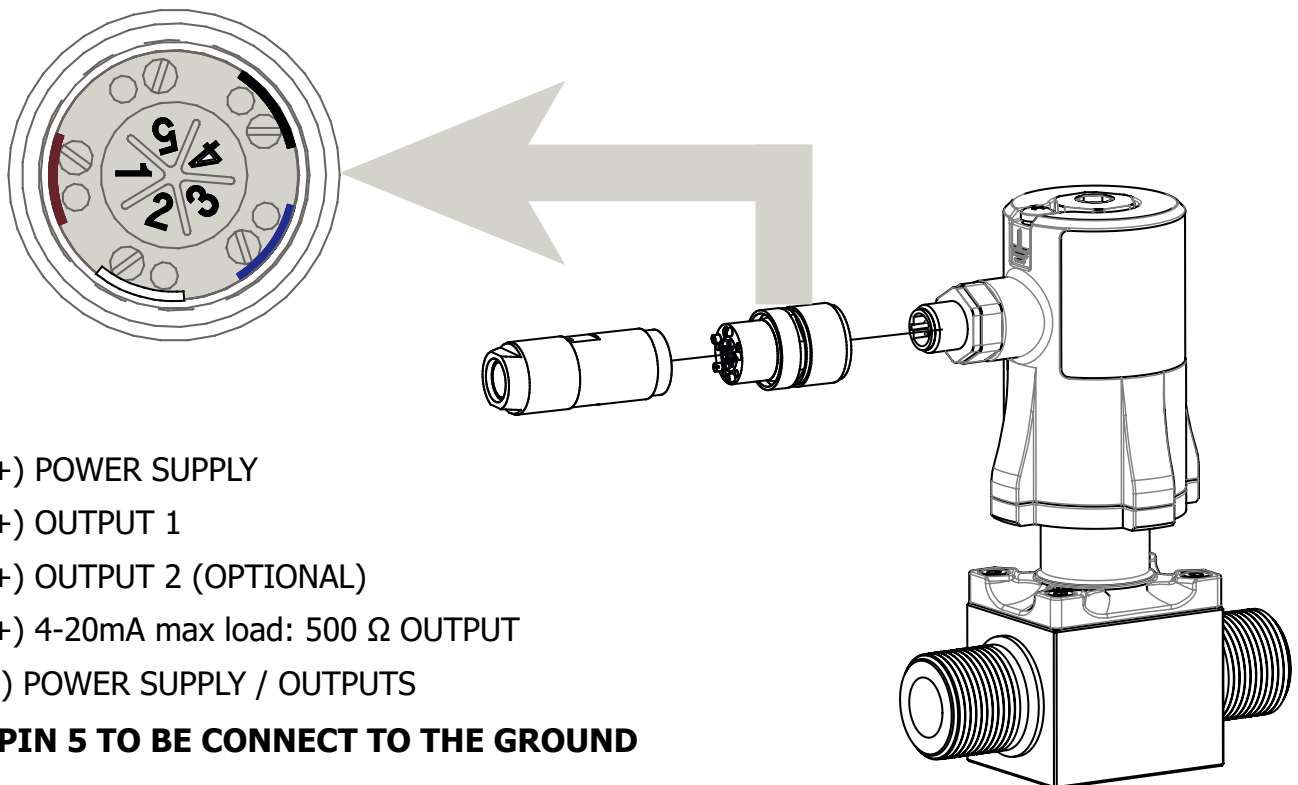

- 1 (+) POWER SUPPLY
- 2 (+) OUTPUT 1
- 3 (+) OUTPUT 2 (OPTIONAL)
- 4 (+) 4-20mA max load: 500 Ω OUTPUT
- 5 (-) POWER SUPPLY / OUTPUTS

 **PIN 5 TO BE CONNECT TO THE GROUND**

GROUNDING CONNECTION

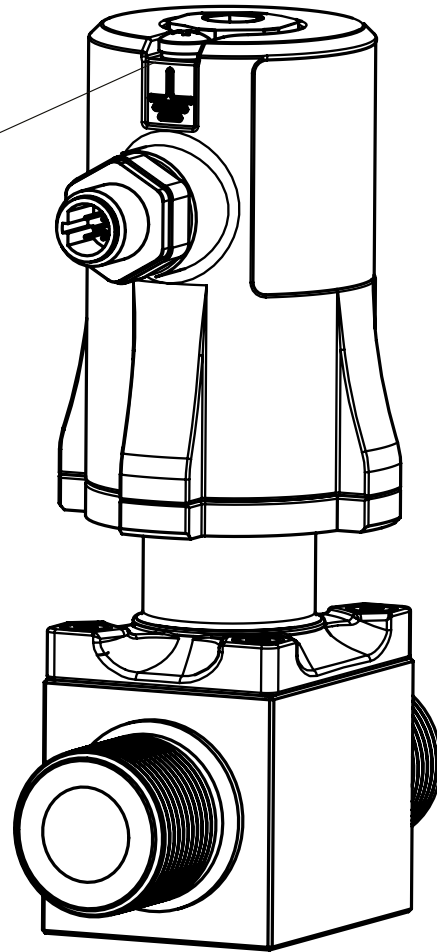
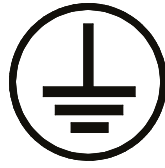

ALWAYS ensure that the instrument is grounded (earthed) correctly. The grounding ensures that the equipment and liquid are equipotential.



POWER SUPPLY

- ❑ Before connecting the power supply, verify that the mains voltage is within the limits indicated on data plate.
- ❑ For the connections use only approved conductors, with fire-proof properties, whose section varies from 0.25mm² to 2.50mm², based on distance/power; additionally, fix the power supply wires with a additional fastening system located close to the terminal.
- ❑ The power supply line must be equipped with an external protection for overload current (fuse or automatic line breaker).
- ❑ Provide in close proximity the converter a circuit breaker easily accessible for the operator and clearly identified; whose symbols must conform to the electrical safety and local electrical requirements.
- ❑ Ensure that the component complies with the requirements of the standard for electrical safety distance.
- ❑ Check chemical compatibility of materials used in the connection security systems in order to minimize electrochemical corrosion.



ON/OFF OUTPUTS

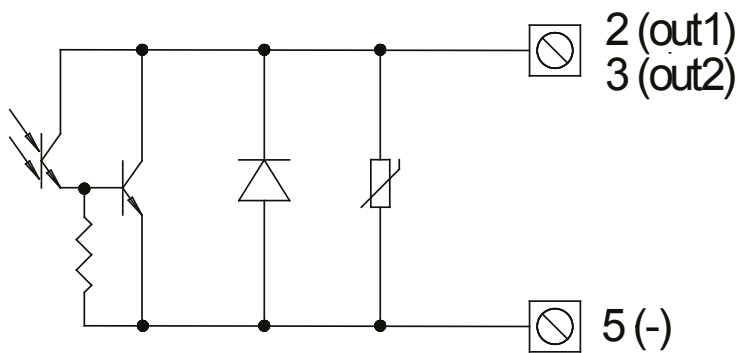

- ❑ Opto-insulated output
- ❑ Maximum switching voltage: 40V
- ❑ Maximum switching current: 100mA
- ❑ Maximum saturation voltage between collector and emitter @100mA: 1.2V
- ❑ Maximum switching frequency (load on the collector or emitter, $R_L=470$, $V_{OUT}=24V$): 1250Hz
- ❑ Maximum reverse current bearable on the input during and accidental polarity reversion (VEC): 100mA
- ❑ Insulation from other secondary circuits: 500V



OUTPUT 4÷20mA

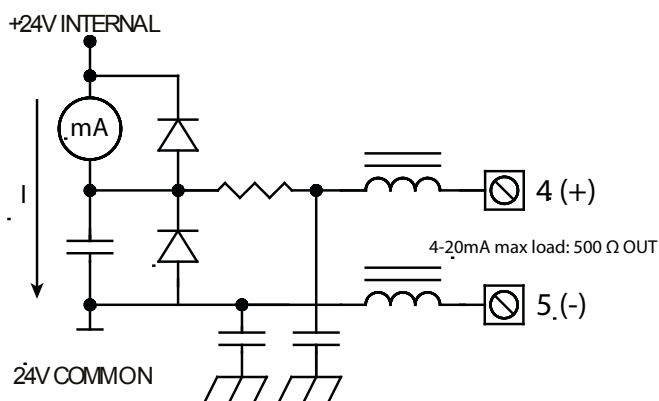

- ❑ Maximum load 500Ω @ 30V
- ❑ Refresh frequency equal to the sample frequency
- ❑ Protected against persistent over voltages up to 30V

NOTE: shielded cables are recommended for input and output wiring

USER INTERFACE

CS3900 can be programmed by MCP interface (USB cable is required see below)

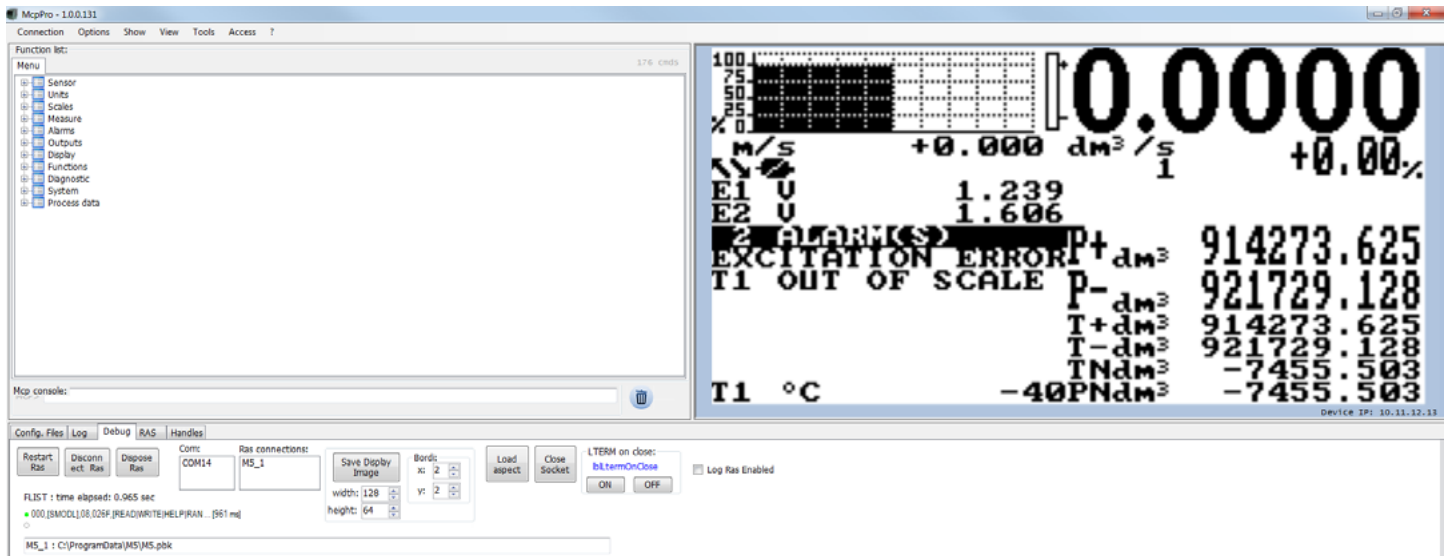

Make the USB connection as shown in the following picture.

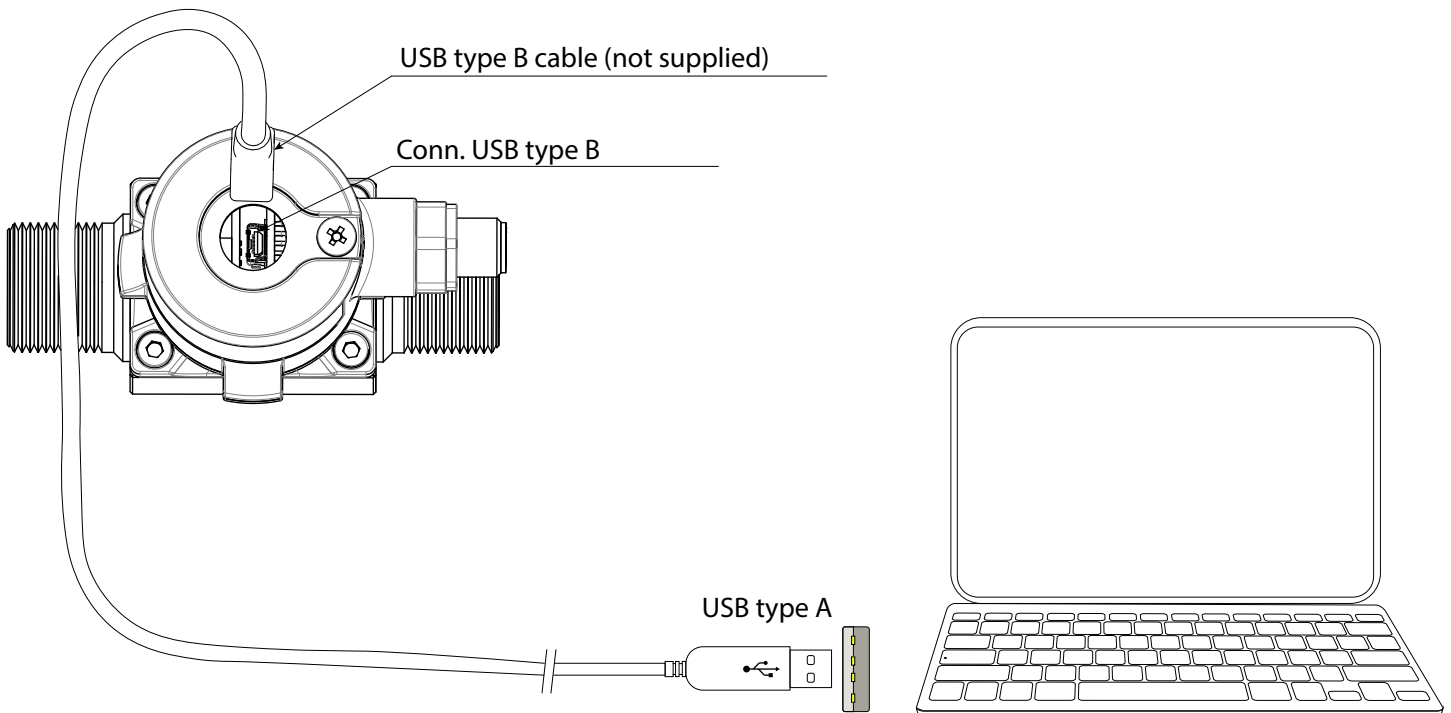

SIGNIFICATO DEI SIMBOLI

ICONE	DESCRIZIONE
	TUBO VUOTO
	CARICAMENTO FILE
	SCARICAMENTO FILE
	SIMULAZIONE PORTATA ATTIVA (LAMPEGGIANTE)
	TARATURA (LAMPEGGIANTE)
	ALLARME GENERICO (LAMPEGGIANTE)
	ALLARME GENERALE SOLO SU SCHERMO FISICO (LAMPEGGIANTE)
	ERRORE DEL SEGNALE
	ERRORE ECCITAZIONE
	ALLARME PORTATA MINIMA
	ALLARME PORTATA MASSIMA
	COMUNICAZIONE ATTIVA
	OVERFLOW PORTATA
	OVERFLOW USCITA IMPULSO 1
	OVERFLOW USCITA IMPULSO 2

START VISUALIZATION PAGES



The visualization pages can be change according to instrument's setup.

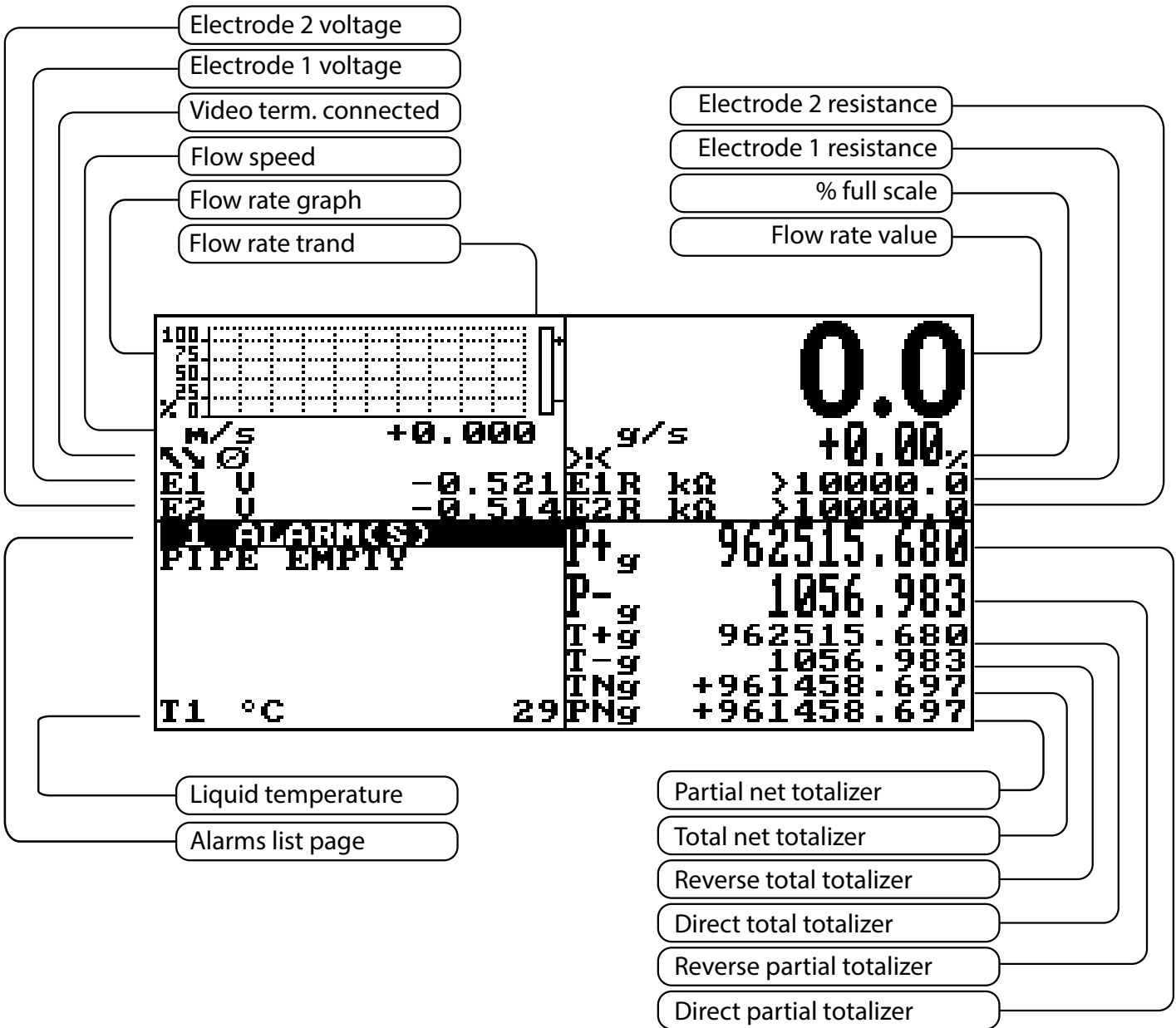

The manufacturer guarantees only English text available on our web site www.isoil.com

FLOW RATE VISUALIZATION

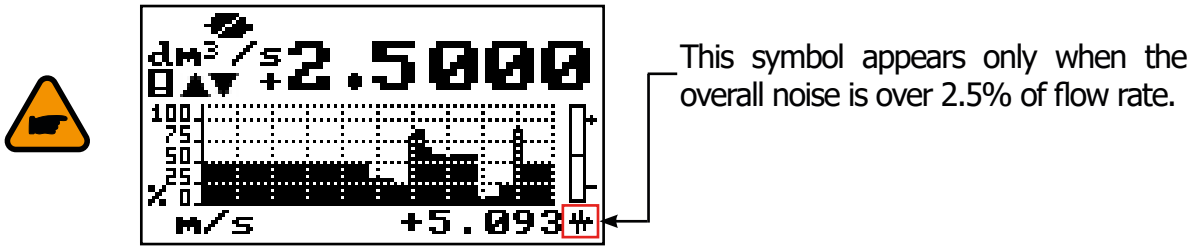

The converter of the meter can show a 5 digits display for flow rate units; this mean the maximum flow rate value that can be represented on the display is 99999 (no matter the positioning of the decimal point). The minimum is 0.0025. The representable measure unit depends on sensor flow rate and diameter; the permitted units are those, that permits the instrument full scale value not exceeding 99999.

Example for DN 300, full scale value: 3m/s:

- PERMITTED measure unit** (example): l/s (216.00); m3/h (777.60); m3/s (0.2160)
- NOT PERMITTED measure unit** (example): l/h (777600)

FLOW RATE ALERT

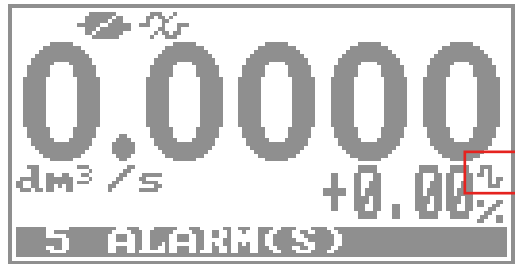

This FLAG becomes active when there is a flow variation (flow rate not stable).

QUICK START MENU

The QUICK START MENU allows to user immediate access to some of the most commonly used functions; through MCP software it possible customize this menu to make it suitable for the specific application.

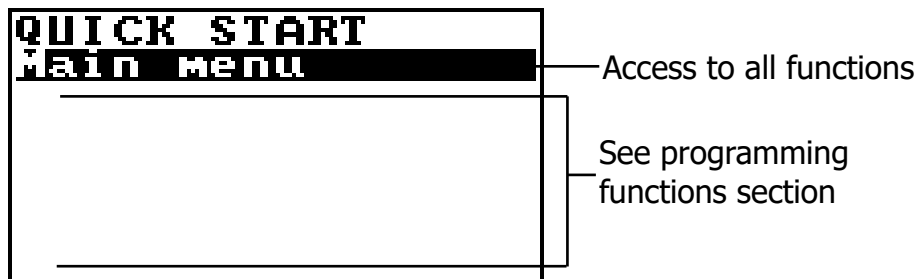

The user has immediate access to the Quick Start menu when the converter is powered up by pressing the Enter key. If access to the quick start menu does not occur, then it could be disabled using the function "2.2 Flowrate type measure unit: metric or imperial" page 18 .

CONVERTER ACCESS CODE

The access for programming the instrument is regulated by six access levels logically grouped. Every level is protected by a different code.

- Access Level 1-2-3-4 Freely programmable by user

ACCESS CODE SET : MENU 13 SYSTEM

```

SYSTEMA
Cod.L1= *****
Cod.L2= *****
Cod.L3= *****
Cod.L4= *****
Cod.L5= *****
Cod.L6= *****
Accesso rist=OFF
Ind.IP dispos.=
Ind.IP client=
Mask rete=
KT= 1.00000
KS= 1.00000
KR= 1.00000
DAC1 4mA= 02460
DAC1 20mA=
FW update
    
```

```

SYSTEM
L1 code=*****
L2 code=*****
L3 code=*****
L4 code=*****
L5 code=*****
L6 code=*****
    
```

Depending on the level of access different display functions will be visible. (See section "FUNCTIONS DESCRIPTION" page 21) These access levels interact with the "Restricted access"

RESTRICTED ACCESS SET : MENU 13 SYSTEM

```

SYSTEM
L1 code=*****
L2 code=*****
L3 code=*****
L4 code=*****
L5 code=*****
L6 code=*****
Restr.access=OFF
    
```

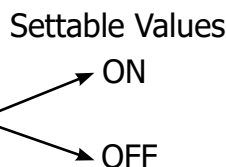

Restrict = ON: Access permitted only to functions provided for a specific level;
 Example: If the operator has a code of access level 3, after having set it, he can change only the functions with level 3 access.

Restict = OFF: It enables to change functions for the selected level and ALL the functions with lower access level.
 Example: If the operator has the code of level 3, after having set it, he can change all the functions at level 3 and those at lower levels.

* WARNING: take careful note of the customized code, since there is no way for the user to retrieve or reset it if lost.

Factory preset access codes:

- L1: 10000000
- L2: 20000000
- L3: 30000000
- L4: 40000000

The following example shows how to change the Full scale by Quick Start menu; the second illustrates how to change the function by the Main menu.

EXAMPLE: modifying the full scale value from 0.4L/s to 0.5L/s, from the "Quick start menu"

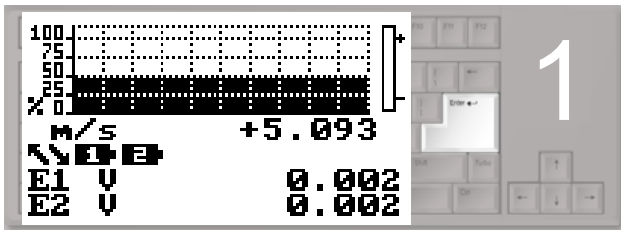

Press enter key to access in the "Quick Start menu"

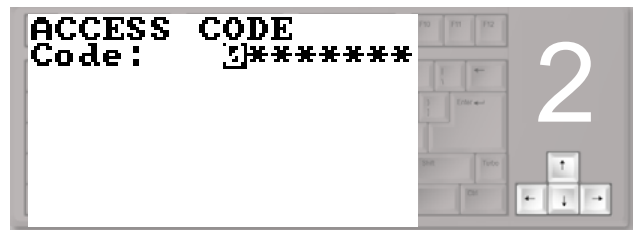

Use the right-left arrow keys to select the character and the up-down arrow key to assign the numeric value of the access code

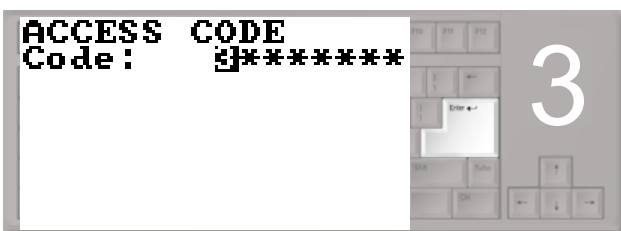

Press the enter key to confirm the access code

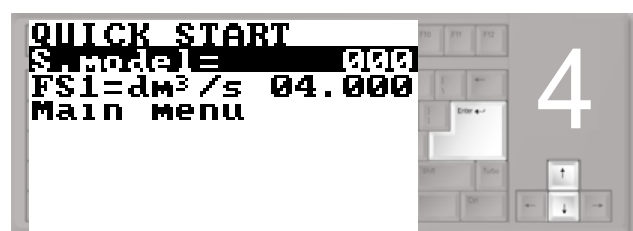

Select the FS1 function with the arrow keys Press the enter key modify the function

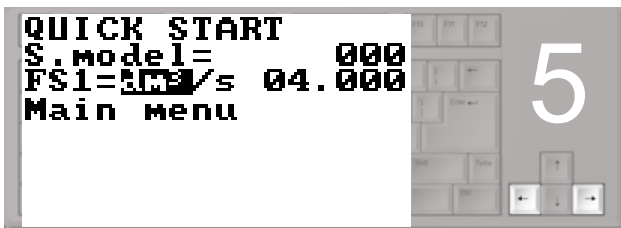

Press the indicated arrow keys to select the character

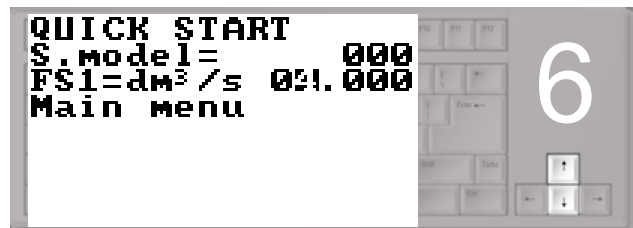

Press the arrow keys indicated to change the value

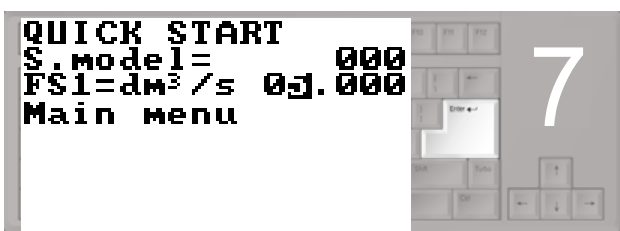

Press the enter button to confirm the changed value



Press the esc key to exit from the "quick start menu" and return to the main page

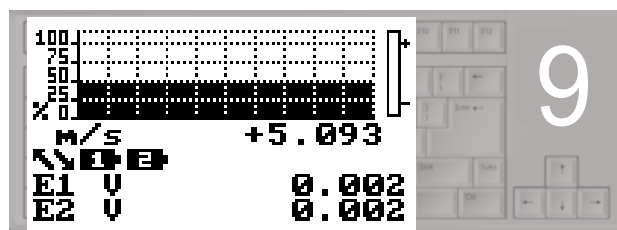

Main Page

EXAMPLE: modifying the full scale value from 0.4l/s to 0.5l/s, from the "Main Menu" (quick start menu enabled)

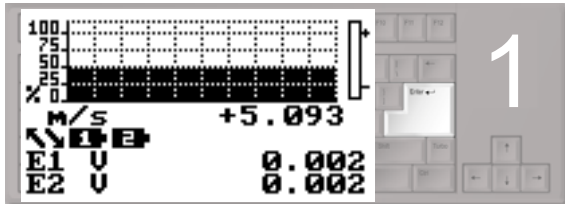

Press enter key to access in the "Quick Start menu"

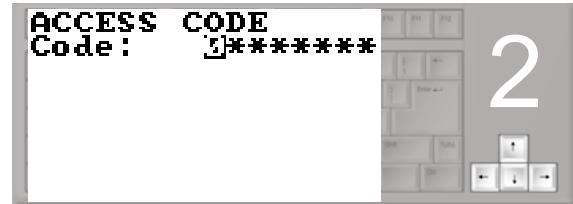

Use the right-left arrow keys to select the character and the up-down arrow key to assign the numeric value of the access code

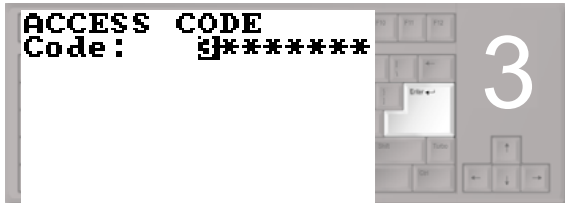

Press the enter key to confirm the access code

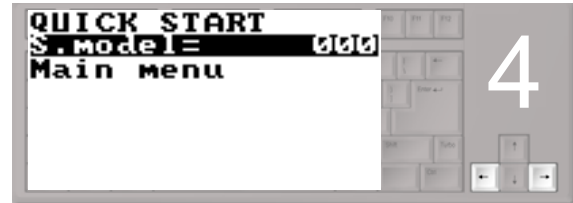

Select the Main Menu function with the arrow keys



Press the enter key to access the main menu

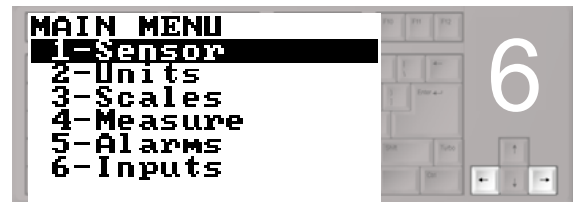

Select menu 3 with the arrow keys

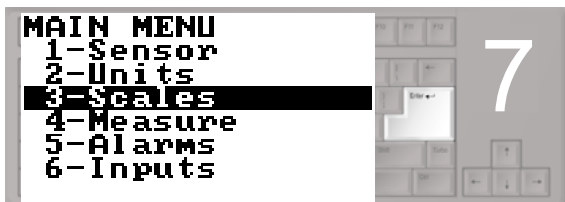

Press the enter key to access menu 3

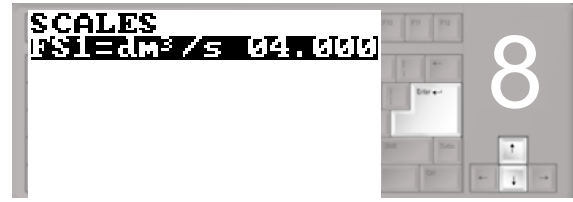

Select the FS1 function with the arrow keys
Press the enter key to confirm

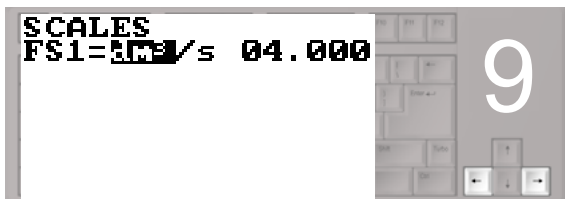

Press the indicated arrow keys to select the character

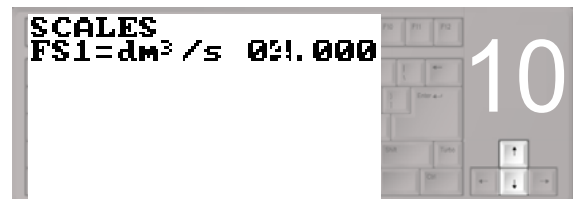

Press the indicated arrow keys to change the value

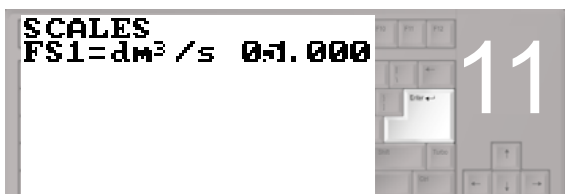

Press the enter key to confirm the changed value

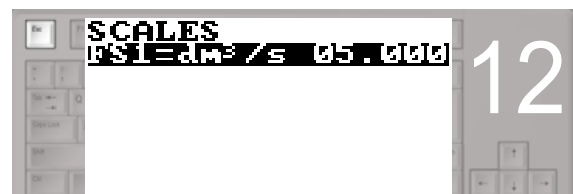

Press the esc key to exit the "quick start menu"

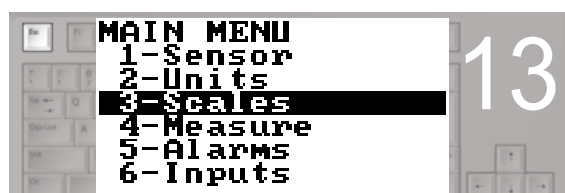

Press the esc key to exit the menu and return to the main page

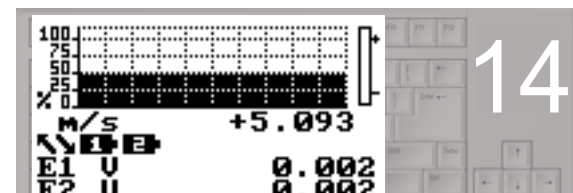

Main Page

PROGRAMMING FUNCTIONS

```

MAIN MENU
1-Sensor
2-Units
3-Scales
4-Measure
11-Flow
12-Pressure
13-Temperature
14-Current
15-Flowrate
16-Flowrate
17-Flowrate
18-Flowrate
19-Flowrate
20-Flowrate
21-Flowrate
22-Flowrate
23-Flowrate
24-Flowrate
25-Flowrate
26-Flowrate
27-Flowrate
28-Flowrate
29-Flowrate
30-Flowrate
31-Flowrate
32-Flowrate
33-Flowrate
34-Flowrate
35-Flowrate
36-Flowrate
37-Flowrate
38-Flowrate
39-Flowrate
40-Flowrate
41-Flowrate
42-Flowrate
43-Flowrate
44-Flowrate
45-Flowrate
46-Flowrate
47-Flowrate
48-Flowrate
49-Flowrate
50-Flowrate
51-Flowrate
52-Flowrate
53-Flowrate
54-Flowrate
55-Flowrate
56-Flowrate
57-Flowrate
58-Flowrate
59-Flowrate
60-Flowrate
61-Flowrate
62-Flowrate
63-Flowrate
64-Flowrate
65-Flowrate
66-Flowrate
67-Flowrate
68-Flowrate
69-Flowrate
70-Flowrate
71-Flowrate
72-Flowrate
73-Flowrate
74-Flowrate
75-Flowrate
76-Flowrate
77-Flowrate
78-Flowrate
79-Flowrate
80-Flowrate
81-Flowrate
82-Flowrate
83-Flowrate
84-Flowrate
85-Flowrate
86-Flowrate
87-Flowrate
88-Flowrate
89-Flowrate
90-Flowrate
91-Flowrate
92-Flowrate
93-Flowrate
94-Flowrate
95-Flowrate
96-Flowrate
97-Flowrate
98-Flowrate
99-Flowrate
100-Flowrate

```

- 1.1 Sensors model: Enter the first two characters of the serial number of the sensor
- 1.2 Flow sensor lining material type
- 1.3 Type of sensor: fullbore or insertion
- 1.4 Type of measure units for sensor parameter: metric or imperial
- 1.5 Insert ND of sensor (0-2500)
- 1.6 Calibration data of sensor
- 1.7 Calibration data of sensor
- 1.8 Sensor coefficient KZ (zero point)
- 1.9 Sensor coefficient KD
- 1.10 Insertion position
- 1.11 KP dynamic, coefficient for insertion
- 1.12 Sensor coefficient Ki
- 1.13 Sensor coefficient Kp
- 1.14 Sensor coefficient KC
- 1.15 Sensor excitation current
- 1.16 Current regulator proportional band
- 1.17 Current regulator derivation constant
- 1.18 Measure sampling frequency
- 1.19 Enables the empty pipe detection feature
- 1.20 Empty pipe detection threshold
- 1.21 Signal error delay (n. sample)
- 1.22 Automatic sensor verify enable
- 1.23 Pipe hydraulic zero calibration
- 1.24 Linearization coefficient

```

MAIN MENU
1-Sensor
2-Units
3-Scales
4-Measure
11-Flow
12-Pressure
13-Temperature
14-Current
15-Flowrate
16-Flowrate
17-Flowrate
18-Flowrate
19-Flowrate
20-Flowrate
21-Flowrate
22-Flowrate
23-Flowrate
24-Flowrate
25-Flowrate
26-Flowrate
27-Flowrate
28-Flowrate
29-Flowrate
30-Flowrate
31-Flowrate
32-Flowrate
33-Flowrate
34-Flowrate
35-Flowrate
36-Flowrate
37-Flowrate
38-Flowrate
39-Flowrate
40-Flowrate
41-Flowrate
42-Flowrate
43-Flowrate
44-Flowrate
45-Flowrate
46-Flowrate
47-Flowrate
48-Flowrate
49-Flowrate
50-Flowrate
51-Flowrate
52-Flowrate
53-Flowrate
54-Flowrate
55-Flowrate
56-Flowrate
57-Flowrate
58-Flowrate
59-Flowrate
60-Flowrate
61-Flowrate
62-Flowrate
63-Flowrate
64-Flowrate
65-Flowrate
66-Flowrate
67-Flowrate
68-Flowrate
69-Flowrate
70-Flowrate
71-Flowrate
72-Flowrate
73-Flowrate
74-Flowrate
75-Flowrate
76-Flowrate
77-Flowrate
78-Flowrate
79-Flowrate
80-Flowrate
81-Flowrate
82-Flowrate
83-Flowrate
84-Flowrate
85-Flowrate
86-Flowrate
87-Flowrate
88-Flowrate
89-Flowrate
90-Flowrate
91-Flowrate
92-Flowrate
93-Flowrate
94-Flowrate
95-Flowrate
96-Flowrate
97-Flowrate
98-Flowrate
99-Flowrate
100-Flowrate

```

- 2.1 Nominal diameter measure unit
- 2.2 Flowrate type measure unit: metric or imperial
- 2.3 Pulse 1 type measure unit: metric or not metric
- 2.4 Pulse 2 type measure unit: metric or not metric
- 2.5 Total direct totalizer measure unit type: metric or imperial
- 2.6 Total direct totalizer measure unit
- 2.7 Total direct totalizer decimal point position
- 2.8 Partial direct totalizer measure unit type: metric or not metric
- 2.9 Partial direct totalizer measure unit
- 2.10 Partial direct totalizer decimal point position
- 2.11 Total reverse totalizer measure unit type: metric or not metric
- 2.12 Total reverse totalizer measure unit
- 2.13 Total reverse totalizer decimal point position
- 2.14 Partial reverse totalizer measure unit type: metric or not metric
- 2.15 Partial reverse totalizer measure unit
- 2.16 Partial reverse totalizer decimal point position
- 2.17 Temperature measure unit
- 2.18 Enable/disable the selection of mass units on full scale set
- 2.19 Specific gravity coefficient

```

MAIN MENU
1-Sensor
2-Units
3-Scales
4-Measure
11-Flow
12-Pressure
13-Temperature
14-Current
15-Flowrate
16-Flowrate
17-Flowrate
18-Flowrate
19-Flowrate
20-Flowrate
21-Flowrate
22-Flowrate
23-Flowrate
24-Flowrate
25-Flowrate
26-Flowrate
27-Flowrate
28-Flowrate
29-Flowrate
30-Flowrate
31-Flowrate
32-Flowrate
33-Flowrate
34-Flowrate
35-Flowrate
36-Flowrate
37-Flowrate
38-Flowrate
39-Flowrate
40-Flowrate
41-Flowrate
42-Flowrate
43-Flowrate
44-Flowrate
45-Flowrate
46-Flowrate
47-Flowrate
48-Flowrate
49-Flowrate
50-Flowrate
51-Flowrate
52-Flowrate
53-Flowrate
54-Flowrate
55-Flowrate
56-Flowrate
57-Flowrate
58-Flowrate
59-Flowrate
60-Flowrate
61-Flowrate
62-Flowrate
63-Flowrate
64-Flowrate
65-Flowrate
66-Flowrate
67-Flowrate
68-Flowrate
69-Flowrate
70-Flowrate
71-Flowrate
72-Flowrate
73-Flowrate
74-Flowrate
75-Flowrate
76-Flowrate
77-Flowrate
78-Flowrate
79-Flowrate
80-Flowrate
81-Flowrate
82-Flowrate
83-Flowrate
84-Flowrate
85-Flowrate
86-Flowrate
87-Flowrate
88-Flowrate
89-Flowrate
90-Flowrate
91-Flowrate
92-Flowrate
93-Flowrate
94-Flowrate
95-Flowrate
96-Flowrate
97-Flowrate
98-Flowrate
99-Flowrate
100-Flowrate

```

- 3.1 Full scale flow rate 1
- 3.2 Full scale flow rate 2
- 3.3 Pulse value on channel 1
- 3.4 Duration of the pulse generated on channel 1
- 3.5 Full scale frequency for channel 1 (0.1Hz-1000.0Hz)
- 3.6 Duration of the pulse generated on channel 2
- 3.7 Pulse value on channel 2
- 3.8 Full scale frequency for channel 2 (0.1Hz-1000.0Hz)

```

MAIN MENU
1-Sensor
2-Units
3-Scales
4-Measure
11-Flow
12-Pressure
13-Temperature
14-Current
15-Flowrate
16-Flowrate
17-Flowrate
18-Flowrate
19-Flowrate
20-Flowrate
21-Flowrate
22-Flowrate
23-Flowrate
24-Flowrate
25-Flowrate
26-Flowrate
27-Flowrate
28-Flowrate
29-Flowrate
30-Flowrate
31-Flowrate
32-Flowrate
33-Flowrate
34-Flowrate
35-Flowrate
36-Flowrate
37-Flowrate
38-Flowrate
39-Flowrate
40-Flowrate
41-Flowrate
42-Flowrate
43-Flowrate
44-Flowrate
45-Flowrate
46-Flowrate
47-Flowrate
48-Flowrate
49-Flowrate
50-Flowrate
51-Flowrate
52-Flowrate
53-Flowrate
54-Flowrate
55-Flowrate
56-Flowrate
57-Flowrate
58-Flowrate
59-Flowrate
60-Flowrate
61-Flowrate
62-Flowrate
63-Flowrate
64-Flowrate
65-Flowrate
66-Flowrate
67-Flowrate
68-Flowrate
69-Flowrate
70-Flowrate
71-Flowrate
72-Flowrate
73-Flowrate
74-Flowrate
75-Flowrate
76-Flowrate
77-Flowrate
78-Flowrate
79-Flowrate
80-Flowrate
81-Flowrate
82-Flowrate
83-Flowrate
84-Flowrate
85-Flowrate
86-Flowrate
87-Flowrate
88-Flowrate
89-Flowrate
90-Flowrate
91-Flowrate
92-Flowrate
93-Flowrate
94-Flowrate
95-Flowrate
96-Flowrate
97-Flowrate
98-Flowrate
99-Flowrate
100-Flowrate

```

- 4.1 Measure filter
- 4.2 Low flow zero threshold: 0-25% of full scale value
- 4.3 Automatic calibration verify
- 4.4 Automatic change of measurement range

The manufacturer guarantees only English text available on our web site www.isoil.com

```

MAIN MENU
1-Sensor
2-Units
3-Scales
4-Measure
5-alarms

```

```

ALARMS
11 Max. thr+=% 000
12 Max. thr-=% 000
13 Min. thr+=% 000
Min. thr-=% 000
Hysteresis=% 03
mA v. alarm=% 010
Hz v. alarm=% 125

```

- 5.1 Maximum value alarm set for direct flow rate
- 5.2 Maximum value alarm set for reverse flow rate
- 5.3 Minimum value alarm set for direct flow rate
- 5.4 Minimum value alarm set for reverse flow rate
- 5.5 Hysteresis threshold set for the minimum and maximum flow rate alarms
- 5.6 Current output value in case of failure
- 5.7 Frequency output value in case of alarms

```

MAIN MENU
1-Sensor
2-Units
3-Scales
4-Measure
5-Alarms
7-Outputs

```

```

OUTPUTS
11 Out1=      FREQ.-
12 Out2=  PULSES+/-
13 Out MA1=4.22 -0+
AIs= g/s 4908.7

```

- 7.1 Output 1 functions
- 7.2 Output 2 functions
- 7.3 Choice of the function and the range of current output
- 7.4 Full Scale value for analog out

```

MAIN MENU
1-Sensor
2-Units
3-Scales
4-Measure
5-Alarms
7-Outputs
9-Display

```

```

DISPLAY
11 Language=      GB
12 D. rate=Hz    1
13 Part. tot.=   ON
Neg. tot.=      ON
Net tot.=       ON
Quick start=    ON

```

- 9.1 Choice of the language
- 9.2 Display updating frequency: 1-2-5-10 Hz
- 9.3 Partial totalizer enable
- 9.4 Negative totalizer enable
- 9.5 Net totalizer enable
- 9.6 Quick start menu visualization

```

FUNCTIONS
11 T+ reset
12 P+ reset
13 T- reset
P- reset
Load Sens.f.def
Load Conv.f.def
Save Sens.f.def
Save Conv.f.def
Calibration

```

- 11.1 Execute immediate reset of total direct totalizer
- 11.2 Execute immediate reset of partial direct totalizer
- 11.3 Execute immediate reset of total reverse totalizer
- 11.4 Execute immediate reset of partial reverse totalizer
- 11.5 Load sensor factory default
- 11.6 Load converter factory default
- 11.7 Save sensor factory default values
- 11.8 Save converter factory default values
- 11.9 Execute immediate internal circuit calibration

```

10-Configurations
12-Diagnostic
13-System

```



```

DIAGNOSTIC
Self test
Sens.verify
Flow sim.= OFF
Display measures
Disp.comm.vars
Display graphs
Firmware info
S/N=
WT=
12-Diagnostic
13-System
    
```

- 12.1 Self test diagnostic function
- 12.2 Sensor verify diagnostic function
- 12.3 Flow rate simulation enabling
- 12.4 Display internal measured value
- 12.5 Display comm. diagnostic values
- 12.6 Display measure as graphs
- 12.7 Firmware version/revision
- 12.8 Board serial number
- 12.9 Total working time

```

SYSTEM
L1 code=*****
L2 code=*****
L3 code=*****
L4 code=*****
L5 code=*****
L6 code=*****
Restr.access=OFF
Device IP addr=
Client IP addr=
Network mask=
KT= 1.00000
KS= 1.00000
KR= 1.00000
DAC1 4mA= 02460
DAC1 20mA= 11050
FW update
13-System
    
```

- 13.1 Access level 1 code
- 13.2 Access level 2 code
- 13.3 Access level 3 code
- 13.4 Access level 4 code
- 13.5 Access level 5 code
- 13.6 Access level 6 code
- 13.7 Restricted access level
- 13.8 Device IP network address
- 13.9 Client IP network address
- 13.10 Network mask
- 13.11 Calibration coefficient KT
- 13.12 Calibration coefficient KF
- 13.13 Calibration coefficient KR
- 13.14 DAC1 out 4mA calibration point
- 13.15 DAC1 out 20mA calibration point
- 13.16 firmware update

The manufacturer guarantees only English text available on our web site www.isoil.com

FUNCTIONS DESCRIPTION



Here below the explanation on how the rows of menu are described.

Menu visualized on the converter (from 1 to 13)
MENU 1 - SENSOR

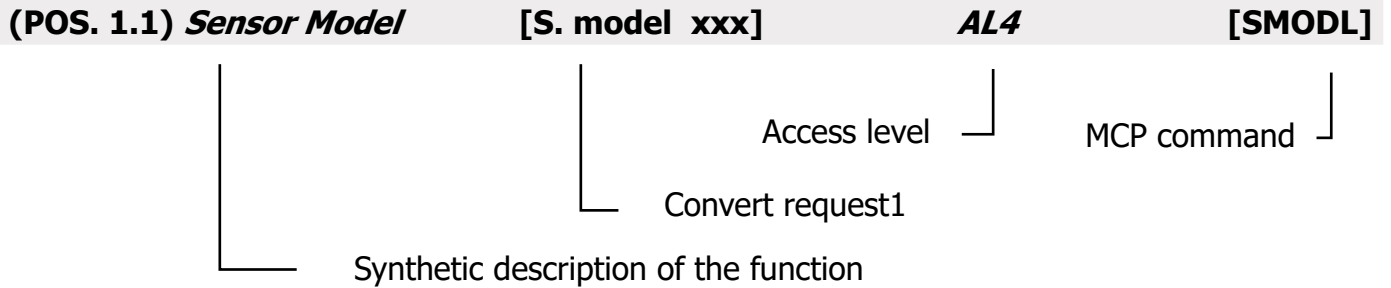

The following picture describes where to find the name of the MCP functions in MCP-software. More info see MCP manual.

The manufacturer guarantees only English text available on our web site www.isomag.com

The screenshot shows the MopPro software interface. On the left, a 'Function list' window displays a tree view of menu items under 'Sensor' and 'Scales'. The selected item is '[Channel 1 pulse volume value]'. Below this, a 'MCP>' line editor contains the command 'OP1PV=' and a 'Star' button. On the right, a larger window shows the same 'Function list' menu, but with the selected item expanded to show sub-items: 'OP1PV? : 1,104:MCPI ACCESS LEVEL NOT VALID', 'OP1PV=? : 1,104:MCPI ACCESS LEVEL NOT VALID', and 'OP1PV='.

Line editor for the insertion and execution of MCP commands.

MENU 1 - SENSOR

(POS. 1.1) *Sensor model* [S. model xxx] AL4 [SMODL]

Enter the first two characters of the serial number of the sensor as on the sensor label.

(POS. 1.2) *Lining Type* [Lining= UNSPEC.] AL4 [LIMAT]

Flow sensor lining material type. (PFA; PU-TDI; ALON; PEEK; HR; PP; PA-11; PTFE-HT; PTFE)

(POS. 1.3) *Type of sensor* [S. type= FULL BORE] AL4 [STYPE]

Select the sensor type of full-bore or insertion.

(POS. 1.4) *Unit type* [U.type= METRIC] AL4 [SUTYP]

Select type of measure unit of sensor's parameter. Values metric or imperial (inch).

(POS. 1.5) *Diameter* [Diam.= mm xxx] AL4 [PDIMV]

Select the nominal diameter of the sensor (0-2500). ND is written on the sensor label.

(POS. 1.6) *KA* [KA= +xx.xxx] AL4 [CFFKA]

KA factor: calibration coefficient

(POS. 1.7) *KA -* [KA= xx.xxx] AL4 [CFFKN]

KA factor: calibration coefficient for negative flow. This function is showed only if at least 1 negative KL value is set.

(POS. 1.8) *KZ* [KZ= +/- xxxxx] AL4 [CFFKZ]

Calibration Factor. KZ is located on the sensor label

(POS. 1.9) *KD* [KD= +/- xxxxx] AL4 [CFFKD]

Calibration Dynamic Factor. KD is located on the sensor label.

(POS. 1.10) *Insertion position* [Ins.position= x] AL4 [SIPOS]

This function is active with POS.1.3 on "Insertion". See the insertion sensor manual for more details

(POS. 1.11) *KP dynamic* [KP dynamic= ON/OFF] AL4 [SIPOS]

This function is active with POS. 1.3 see page 18 set on insertion. See manual of insertion sensor for more details

(POS. 1.12) *Ki* [Ki= +/- xx.xxx] AL4 [CFFKI]

This function is active with POS. 1.3 see page 18 set on insertion. See manual of insertion sensor for more details

(POS. 1.13) *Kp* [Kp = +/- xxxxx] AL4 [SIDKP]

This function is active with POS. 1.3 see page 18 set on insertion. See manual of insertion sensor for more details

(POS. 1.14) *KC* [KC= +/- xx.xxx] **AL4** [CFFKC]

Calibration Factor. This function is activated if the sensor model is NOT present on the sensors table standard parameters

(POS. 1.15) *Coils Ex.Current* [C.Curr.= mA xxx.x] **AL4** [CEXCC]

Excitation coils current. This function is activated if the sensor model is NOT present on the sensors table standard parameters

(POS. 1.16) *C. Reg. PB* [C.Reg.PB= xxx] **AL4** [CRPRB]

Current regulator parameter. This function is activated if the sensor model is NOT present on the sensors table standard parameters

(POS. 1.17) *C. Reg. DK* [C.Reg. DK = xxx] **AL4** [CRDER]

Current regulator parameter. This function is activated if the sensor model is NOT present on the sensors table standard parameters

(POS. 1.18) *S. Freq.* [S.Freq.= Hz xx] **AL4** [SFREQ]

Measure sampling frequency. This function is activated if the sensor model is NOT present on the sensors table standard parameters

(POS. 1.19) *Empty Pipe Detection* [E.P.Detect= ON] **AL4** [EPDEN]

Enables the empty pipe detection function. This function is useful to keep the meter lock to zero when the pipe become empty.

(POS. 1.20) *Empty pipe thr.* [R max= Kohm xxxx] **AL4** [EPDTH]

Maximum resistance value at the inputs (electrodes) determine the empty pipe condition. This feature is enabled only if the "1.19 Enables the empty pipe detection feature" page 18 Empty Pipe Detection is ON.

(POS. 1.21) *Signal error delay* [S.err.delay=m xxx] **AL4** [SEALT]

Delay before generating error. This function is useful to prevent unexpected lock to zero of measure caused by sporadic events (empty pipe, excitation error, signal error)

(POS. 1.22) *Sensor verify* [Sens. verify= OFF] **AL3** [ASVFE]

Enable the Automatic sensor verification (see BIV optional function).

(POS. 1.23) *Zero point calibration* [Zero point cal.]

This feature appears only when the process conditions are as follow:

- measure filters recommended (Damping) set to SMART 2 second / 5 second
- stable flow rate and lower than 0.1% of the absolute scale (10 m/s)
- It must have elapsed at least 10 minutes after the last significant change of flow rate

When the above conditions are met, the zero point calibration function will appears on the display, press the "Enter / ESC" and automatically the procedure will start.

NOTICE: Be sure that the the sensor is completely full of liquid and perfectly still. Even subtle movements of the fluid can cause significant errors, therefore proceed with great care.

Coefficient KL [MCP ONLY] **AL4** [SETKL]

Linearization coefficient for negative flow, reserved to the service. This command is only showed if SMODL = 000.

MENU 2 - UNITS

WARNING: The totalizer value is updated and changed depending on the setting of unit value. The scale change may cause accuracy loss depending of rounding up. For example, if T +=0,234 liters with 3 decimals, it become T +=0.001 m³ losing 0.234 liters in rounding up.

(POS. 2.1) Diameter [Diam.= mm] AL2 [SDIUM]

Sensor diameter unit of measure (mm or inch)

(POS. 2.2) Flow rate unit of m. type [FR unit= METRIC] AL2 [FRMUT]

Flow rate type measure unit. Select metric or not metric (Imperial units)

(POS. 2.3) Pulse 1 unit of m. type [PL1 unit= METRIC] AL2 [PL1UT]

This function is active with POS. 7.1 see page 19 enable.

This function changes the choice of measure unit POS. 3.3 see page 18

Pulse 1 type measure unit: metric or not metric (Imperial units).

(POS. 2.4) Pulse 2 unit of m. type [PL2 unit= METRIC] AL2 [PL2UT]

This function is active with POS. 7.2 see page 19 enable.

This function changes the choice of measure unit POS. 3.7 see page 18

Pulse 2 type measure unit: metric or not metric Imperial units).

(POS. 2.5) Totalizer direct unit of m. type [T+ unit= METRIC] AL2 [TTPUT]

Setting total direct totalizer measure unit type: metric or not metric Imperial units).

This function changes the values measure unit on POS. 2.6 see page 18

(POS. 2.6) Totalizer direct unit of measure [T+ unit= dm³] AL2 [TTPUM]

Setting total direct totalizer measure unit.

This function visualized on visualization pages.

(POS. 2.7) Totalizer direct Deci.Point pos. [T+ D.P.= x] AL2 [TTPDP]

Setting total direct totalizer decimal point position.

Example: T+D.P.= 3 visualized value T+dm³ 0.000 / T+D.P.= 2 visualized value T+dm³ 0.00

(POS. 2.8) Total. Part. direct unit of m. type [P+ unit= METRIC] AL2 [TPPUT]

This function is active with POS. 9.3 see page 19 enable.

Setting partial direct totalizer measure unit type: metric or not metric (Imperial units).

This function changes the values measure unit on POS. 2.9 see page 18 .

It is visualized on visualization pages.

(POS. 2.9) Total. Partial+ unit of measure [P+ unit= dm³] AL2 [TPPUM]

Setting partial direct totalizer measure unit.

This function visualized on visualization pages.

(POS. 2.10) Total. Part direct Dec. Point pos. [P+ D.P.= x] AL2 [TPPDP]

Setting partial direct totalizer decimal point position.

Example: P+D.P.= 3 visualized value P+dm³ 0.000 / P+D.P.= 2 visualized value P+dm³ 0.00

(POS. 2.11) Total. T reverse unit of m. type [T- unit= METRIC] AL2 [TTNUT]

This function is active with POS. 9.4 see page 19, enabled.

Setting total reverse totalizer measure unit type: metric or not metric (Imperial units).

This function changes the values measure unit on POS. 2.12 see page 18.

It is visualized on visualization pages.

(POS. 2.12) Total. T reverse unit of meas. [T- unit= dm³] AL2 [TTNUM]

Setting total reverse totalizer measure unit.

This function visualized on visualization pages.

(POS. 2.13) Total. T reverse Dec. Point Pos. [T- D.P.= x] AL2 [TTNDP]

Setting total reverse totalizer decimal point position.

Example: T- D.P.= 3 visualized value T- dm³ 0.000

T- D.P.= 2 visualized value T- dm³ 0.00

(POS. 2.14) Total. Part. reverse unit of m. type [P- unit= METRIC] AL2 [TPNUT]

This function is active with POS. 9.4 see page 19, enable.

Setting partial reverse totalizer measure unit type: metric or not metric (Imperial units).

This function changes the values measure unit on POS. 2.15 see page 18

It is visualized on visualization pages.

(POS. 2.15) Total. Part. reverse unit of measure [P- unit= dm³] AL2 [TPNUM]

Setting partial reverse totalizer measure unit.

This function visualized on visualization pages.

(POS. 2.16) Tot Part. reverse Dec. Point Pos. [P- D.P.= x] AL2 [TPNDP]

Setting partial reverse totalizer decimal point position.

Example: P- D.P.= 3 visualized value P-dm³ 0.000

P- D.P.= 2 visualized value P-dm³ 0.00

(POS. 2.17) Temperature unit of measure [Temp. unit= C°] AL2 [TMPUT]

Setting temperature measure unit.

(POS. 2.18) Mass units enable [Mass units= dm³] AL2 [MSSUE]

Enable or Disable the selection of mass unit of full scale set.

(POS. 2.19) Specific Gravity coeffic. [Sg= Kg/dm³ x.xxxx] AL2 [VMSGC]

Setting specific gravity coefficient. This Function is active with POS. 2.18 see page 18, enable.

MENU 3 - SCALE

(POS. 3.1-2) Flow Rate Full Scale 1-2 [FS1-2= l/s xxxx.x] AL2 [FRFS1-FRFS2]

The FS2 (full scale flow rate 2) is active with POS. 4.4 see page 18 ,enabled.

The full scale is used to indicate to the maximum meter's flow rate. The full scale should be chosen carefully as it's parameters are used for several other parameters. There are three fields to fill in order to set this parameter, from left to right: 1) measure unit, 2) time unit of measure and 3) numeric value. The selection is made by positioning the cursor on the field to modify. To change the type unit of measure (metric, Imperial units, mass or volume) see POS. 2.2 see page 18 and POS. 2.18 see page 18 and POS. 2.19 see page 18. The value of Fs1-2 depend nominal diameter POS. 1.4 see page 18. The following tables shown the units of measure available and the conversion factor by comparison with 1dm³ and 1kg. The converter accepts any kind of combination of units of measure satisfying both the following conditions:

- Numeric field value 99999
- $1/25 \text{ fsmax} \leq \text{numeric field value} \leq \text{fsmax}$.

Where fsmax is the maximum full scale value corresponding to the sensor, equal to a 10m/s liquid speed. The measure units are shown as appear on the display. The Imperial units units are diversified by using capital and small characters.

METRIC	
cm³	Cubic centimeter
ml	Milliliter
l	Liter
dm³	Cubic decimeter
dal	Decalitre
hl	Hectolitre
m³	Cubic meter
ML	Mega Liter

NOT METRIC	
in³	Cubic inch
Gal	American gallon
ft³	Cubic foot
bbf	Standard barrel
BBL	Oil barrel
IGL	Imperial gallon

MASS UNIT NOT METRIC	
Oz	Ounce
Lb	Pound
Ton	Short tons

MASS UNIT METRIC	
g	Gram
kg	Kilogram
t	Ton

When a measure mass unit is set, the specific gravity function is automatically enabled by the system. Please, note that the mass measure is heavily affected by the temperature. With certain liquids this may cause significant measurement errors. The following measure of time units can be selected: **s** = second, **m** = minute, **h** = hour, **d** = day .

NOTES FOR USING THE MCP INTERFACE

The command FRFS1 =? and command FRS2 = ?, edited by MCP software, return a list of only the unit compatible with the nominal diameter set. If the sensor is insertion type and the diameter is zero, the only possible unit is m/s if the flow rate were chosen metric units, else f/s for the unit of measurement non metric.

(POS. 3.3-3.5) Output Pulse 1-2 [Pls1-2= dm³ x.xxxxx] AL2 [OP1PV-OP2PV]

Pls1 and Pls2 is active with POS. 7.1 see page 19 and POS. 7.2 see page 19, enable and setting pulse value on channel 1 and channel 2. This function allows the user to set a signal (a pulse) to be given from the converter when a defined amount of liquid has passed through the sensor. To set the parameter, complete the 2 fields, from left to right: 1) measure unit, 2) numeric value. The selection is performed by positioning the cursor in the field to be modified. To change the unit type (metric, British or American, mass or volume) see POS. 2.3 see page 18 and POS. 2.4 see page 18, POS. 2.18 see page 18 and POS. 2.19 see page 18. The value of Pls1-2 depends on nominal diameter POS. 1.4 see page 18. Only those units described (POS. 3.1 see page 18-POS. 3.2 see page 18) above are available to be selected.

(POS. 3.4-3.6) Output 1-2 Pulse Time [Tpls1-2= ms x.xxxxx] AL2 [OP1PT OP2PT]

Tpls1 and Tpls2 is active with POS. 7.1 see page 19 and POS. 7.2 see page 19 enable. Setting duration of the pulse generated on channel 1 and 2.

With the liquid volume to generate the pulse value (POS. 3.3 see page 18 POS. 3.7 see page 24) set by the user. The user must set the corresponding duration of the pulse to be outputed. This value is expressed in milliseconds and has to be between 0.4 and 9999.99. When the high frequency output is present, then the minimum value can type of device is connected to the converter, the user must verify that the set pulse duration is compatible with the external device processing such pulses. If, for example, an electro-mechanical pulse counter is connected, a minimum pulse time of 0.04 milliseconds can be set.

ATTENTION: The converter can not detect problems that may occur; firstly, the pulse is too long the coils may burn out, secondly, if the pulse is too short, the counter may not be able to function, causing damage of the output.

(POS. 3.7-3.8) Output full scale freq.1-2 [Frq1-2= x.xxxxx] AL2 [OU1FF-OU2FF]

Frq1 and Frq2 are activated with POS. 7.1 see page 19 and POS. 7.2 see page 19 enabled and set to the value freq+/-/+-. Setting duration of the pulse generated on channel 1 and 2.

MENU 4 - MEASURE

(POS. 4.1) Damping [Damping=OFF/SMART/(TIME)] AL3 [MFDMP]

This section of manual is extremely important because the correct setting of the filters allows to obtain a proper response of the instrument to the measured flow rate and the specific requirements of use; as a general rule, consider that, starting from Damping = OFF (no filter applied to the measure), successive values, introduce increasing damping. The following diagrams show the instrument's response to changes in flow rate from 0 to 100%, using the different settings of the damping function.

The SMART is an adaptive filter that adapts automatically to most of the processes (recommended value), making the response of the meter very ready to fast changes of flow and at the same time extremely precise and stable for slow variations. It may be convenient to use a constant damping filter time, where there is a pulsating flow (for example generated by peristaltic pumps). With longer times you get a mean value stable, while with short times the measure will closely follow the flow pulses, but consequently more unstable. NOTE: If the rechargeable battery is active, the damping could be set only in "SMART".

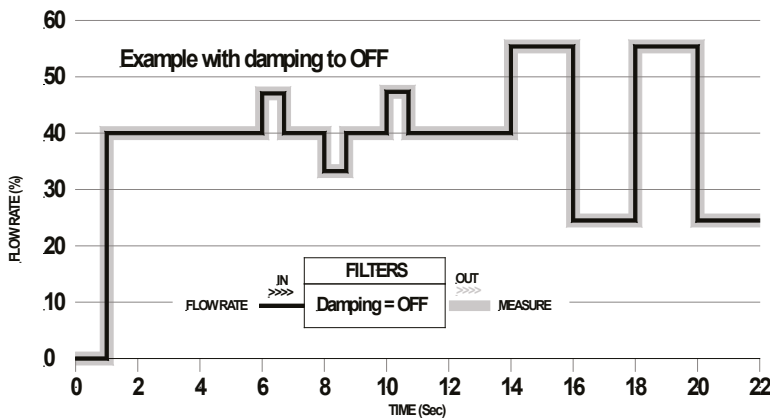

Damping function(OFF). the meter follows the trend of fast changes in flow.

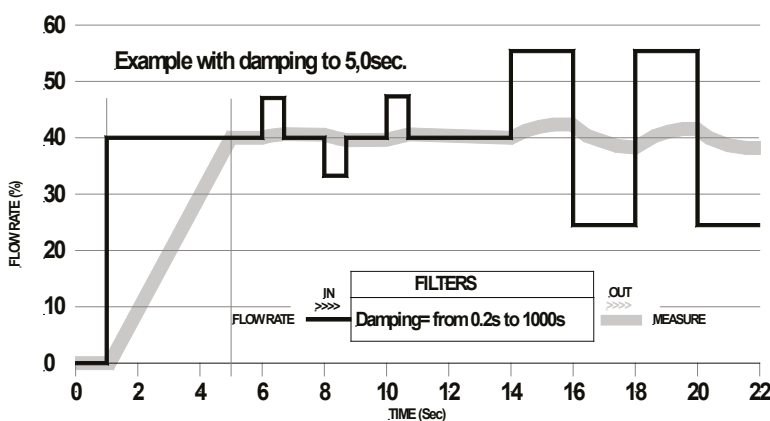

Damping mode based on time (fro 0.2s to 1000s) The measure is averaged over a number of samples determined by the value assigned to the dampening function. When the damping parameter is expressed in seconds, the filter works damping the measurement noise and sudden change of flow rate. Increasing the parameter of damping increases the stability of the measurement.

The manufacturer guarantees only English text available on our web site www.isoil.com

(POS. 4.2) <i>Cut-off threshold</i>	[Cut-off=% xxx]	AL3	[MFCUT]
--	------------------------	------------	----------------

Setting the low flow cutoff threshold. This function is useful to avoid that flows close to zero, due to the electrical noises from tiny movements of liquid (due for example to vibrations of the pipe) which cause an increasing of the totalizers. The allowed range for this function is 0-25% of full scale set. For most applications a value between 0.5 and 1% is recommended.

(POS. 4.3) <i>Calibration verify</i>	[Cal.verify=ON]	AL3	[ACAVE]
---	------------------------	------------	----------------

This function enables an automatic verification of board's coefficients. As the converter performs continuously a large number of tests, we recommend to use this function only in presence of wide range of temperature. Instead it is NOT recommended to use it when the instrument is used in metering applications (batch).

(POS. 4.4) <i>Automatic scale change enable</i>	[Autorange=ON/OFF]	AL3	[ARNGE]
--	---------------------------	------------	----------------

Enables the automatic change of scale. The meter may have two different working ranges in order to suit to the variable process conditions. In order to get the best results out of this function it is important range N.2 (Fs2) if enabled is bigger than N.1 (Fs1). When the flow rate increases and reaches the 100% of the full scale 1, then the meter automatically switches to scale 2. When the flow rate decreases again reaching a value on scale 2 equal to the 90% of full scale N.1, then the active scale is 1 again. Allowed values for this parameter: ON/OFF.

This function does NOT increase the accuracy of the measure; its aim is to increase the resolution of 4/20 mA when the meter work at very low flow rates (typical case the flow rate of water distribution with daytime flow much higher than the night flow).

MENU 4 - MEASURE: ONLY MCP FUNCTIONS

<i>Measure Filter Cut-off Threshold 2</i>	[MCP ONLY]	AL3	[MFCT2]
--	-------------------	------------	----------------

Setting the low flow cutoff threshold, it is similar to the function in 4.2.

<i>High immunity INPUTS</i>	[MCP ONLY]	AL4	[HIINP]
------------------------------------	-------------------	------------	----------------

The HIINP function (INPUT High Immunity filter) introduces a hardware filter to be used ONLY IN CASE OF ABSOLUTE NECESSITY, when the measure is absolutely unstable or it is NOT possible to make the measure, and every possible attempt to reduce or eliminate the noise do not give a positive result, with particular attention of instrument ground connection. When this function is activated (HIINP = ON) the measure will be influenced by an unavoidable error estimated around 1%.

<i>Dynamic sample analysis</i>	[MCP ONLY]	AL4	[DINSA]
---------------------------------------	-------------------	------------	----------------

Reserved to the service

<i>Dynamic sample time</i>	[MCP ONLY]	AL4	[DYNST]
-----------------------------------	-------------------	------------	----------------

Reserved to the service

MENU 5 - ALARMS

(POS. 5.1) Maximum direct flow rate threshold [Max. thr+=% XXX] AL3 [FRAXP]

Maximum value alarm set for direct flow rate set. When the flow rate value exceeds such a threshold, then an alarm message is generated. The value of this parameter is expressed as percentage of the full scale value and may be set from 0 to 125%. Setting this parameter to zero disables the alarm generation.

(POS. 5.2) Maximum reverse flow rate threshold [Max. thr-=% XXX] AL3 [FRAXN]

Maximum value alarm set for reverse flow rate set. When the flow rate value exceeds such a threshold, then an alarm message is generated. The value of this parameter is expressed as percentage of the full scale value and may be set from 0 to 125%. Setting this parameter to zero disables the alarm generation.

(POS. 5.3) Minimum direct flow rate threshold [Min. thr+=% XXX] AL3 [FRANP]

Minimum value alarm set for reverse flow rate set. When the flow rate value falls below such a threshold, then an alarm message is generated. The value of this parameter is expressed as percentage of the full scale value and may be set from 0 to 125%. Setting this parameter to zero disables the alarm generation.

(POS. 5.4) Minimum reverse flow rate threshold [Min. thr-=% XXX] AL3 [FRANN]

Minimum value alarm set for reverse flow rate set. When the flow rate value falls below such a threshold, then an alarm message is generated. The value of this parameter is expressed as percentage of the full scale value and may be set from 0 to 125%. Setting this parameter to zero disables the alarm generation.

(POS. 5.5) Hysteresis [Hysteresis=% XX] AL3 [ATHYS]

Hysteresis threshold set for the minimum and maximum flow rate alarms. The value of this parameter is expressed as percentage of the full scale value and may be set from 0 to 25%.

(POS. 5.6) Current output value in case of failure [mA V.alarm =% XXX] AL3 [OCACV]

The output current signal can be specified by the user in case of failure of either, empty pipe, coils interrupted, or ADC error. The signal current is set as a percentage (0 to 125%) of the 0/4-20mA current. 125% corresponds to 24mA and does not depend on the selected range (0-20/4-20mA).

The NAMUR NE43 recommendation asks for a alarms signalling value for the current output lower than 3.6mA (<18%) or bigger than 21mA (>105%). It would then be preferable to set the value of this function at the 10%, so that the current value in case of the a.m. cases would be 2 mA, allowing the following diagnostics:

- current < 2mA - 5%: line interrupted, power supply failure or faulty converter;
- 2mA -5% * current * 2mA + 5%: hardware alarm;
- 4mA * current * 20mA: normal working range;
- 20mA < current * 22mA: out of range, measure above 100% f.s.

(POS. 5.7) Frequency output value in case of failure [Hz V.alarm=%XXX] AL3 [OFACV]

This function is active with POS. 7.1 see page 19 and POS. 7.2 see page 19 enable to (FREQ.+, FREQ.-, FREQ.±) To set the frequency value assigned to the on/off output in one or more of the following failure cases:

- Empty pipe; Coils interrupted ; ADC error. Allowable range is from 0 to 125% of the frequency full scale value. Although there are no specific rules regulating cases such as these, it would be convenient to use the failure information as follows:
- 0% Hz * frequency * 100% f.s.: normal working range;
- 100% f.s. < frequency * 110% f.s.: overflow, measure above the 100% of the f.s.;
- 115% f.s. * frequency * 125% f.s.: hardware alarm condition.

MENU 7 - OUTPUTS

(POS. 7.1) Output 1 function selection [Out1=XXXXXX] AL3 [OUT1F]

Function choice corresponding to digital Output 1. The functions are listed in the table below.

(POS. 7.2) Output 2 function selection [Out2=XXXXXX] AL3 [OUT2F]

Function choice corresponding to digital Output 2. The functions are listed in the table below.

FUNCTIONS FOR OUTPUTS 1 AND 2

- OFF:** DISABLE
- MAX AL. +:** MAX DIRECT FLOW RATE OUTPUT (ENERGIZED = AL. OFF)
- MIN AL. +:** MIN DIRECT FLOW RATE OUTPUT (ENERGIZED = AL. OFF)
- MAX AL.-:** MAX INVERSE FLOW RATE OUTPUT (ENERGIZED = AL. OFF)
- MIN AL.-:** MIN INVERSE FLOW RATE OUTPUT (ENERGIZED = AL. OFF)
- MAX/MIN-:** MAX/MIN INVERSE FLOW RATE OUTPUT (ENERGIZED = AL. OFF)
- MAX/MIN+/-:** MAX/MIN DIRECT FLOW RATE OUTPUT (ENERGIZED = AL. OFF)
- P.EMPTY:** EMPTY PIPE ALLARM OUTPUT (ENERGIZED = AL. OFF)
- AL.SYSTEM:** SUM OF ALL ALARMS "energized interrupted " AND "error input signal "
- OVERFLOW:** OUT OF RANGE ALLARM OUTPUT (ENERGIZED = FLOWRATE OK)
- ALL ALARMS:** SUM OF ALL ALARMS POSSIBLE
- MANUAL:** OUTPUT MAY TAKE A STATE EMPLOYEE FROM AN EXTERNAL CONTROL (MCP,MODBUS, ecc)
- FLOW RATE SIGN.:** FLOW DIRECTION (ENERGIZED WHEN FLOW IS NEGATIVE)
- SCALE:** INDICATION SCALE
- FREQ.+::** FREQUENCY POSITIVE FLOWRATE
- FREQ.-:** FREQUENCY NEGATIVE FLOWRATE
- FREQ.+/-:** FREQUENCY POSITIVE/NEGATIVE FLOWRATE
- PULSES.+::** PULSE POSITIVE FLOW RATE
- PULSES.-:** PULSE NEGATIVE FLOW RATE
- PULSES+/-:** PULSE NEGATIVE/POSITIVE FLOW RATE

(POS. 7.3) Current output option and range [Out mA1=X_XXXXX] AL3 [A01CF]

This function sets the current output 1 and 2. This function is optional and will not appear unless the option has been requested. There are three fields to modify for this function:

- Scale zero: 4 or 0mA
- Full scale: 20 or 22mA
- Field: + = positive, - = negative, blank = both, -0+ = central zero scale

The values corresponding to the scale points are shown in the following chart:

CURRENT VALUES IN mA ASSOCIATE TO THE % FULL SCALE VALUE					
POSSIBLE FIELD	REVERSE FLOW VALUE		ZERO	DIRECT FLOW VALUE	
	≤-110%	-100%		+100%	≥+110%
Out.mA = 0 ÷ 20 +	0	0	0	20	20
Out.mA = 0 ÷ 22 +	0	0	0	20	22
Out.mA = 4 ÷ 20 +	4	4	4	20	20
*Out.mA = 4 ÷ 22 +	4	4	4	20	21.6
Out.mA = 0 ÷ 20 -	20	20	0	0	0
Out.mA = 0 ÷ 22 -	22	20	0	0	0
Out.mA = 4 ÷ 20 -	20	20	4	4	4
Out.mA = 4 ÷ 22 -	21.6	20	4	4	4
Out.mA = 0 ÷ 20	20	20	0	20	20
Out.mA = 0 ÷ 22	22	20	0	20	22
Out.mA = 4 ÷ 20	20	20	4	20	20
Out.mA = 4 ÷ 22	21.6	20	4	20	21.6
Out.mA = 0 ÷ 20 -0+	0	0	10	20	20
Out.mA = 0 ÷ 22 -0+	0	1	11	21	22
**Out.mA = 4 ÷ 20 -0+	4	4	12	20	20
Out.mA = 4 ÷ 22 -0+	2	4	12	20	22

In hardware alarm conditions "HARDW AL." (interrupted coils, empty pipe, measure error) the current value is programmed by the function "mA v.fault" (pos. 4.4) and it is expressed as percentage of a fixed current range, where: 0% = 0mA and 110% = 22mA.

* Example 1: out 4-22 +

** Example 2: out 4-20 -0+

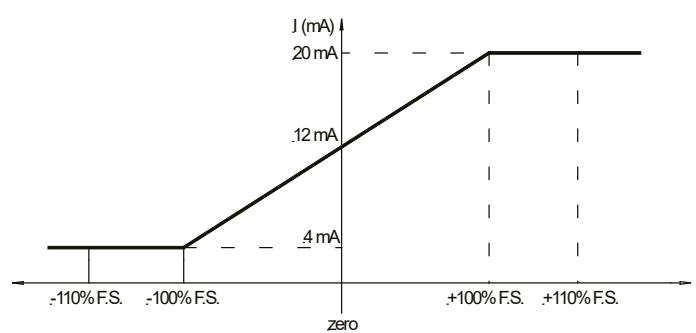
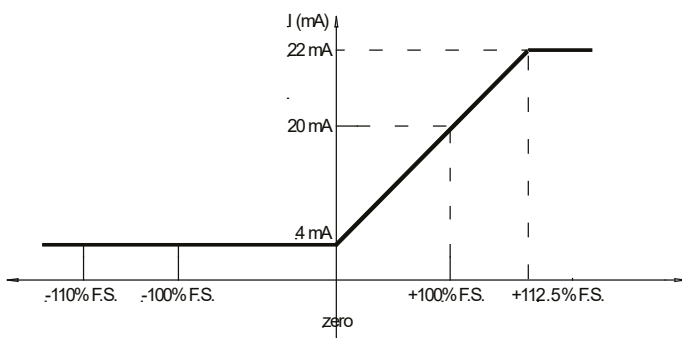

(POS. 7.4) Analog Output1 full scale

[A1S= dm/s x.xxxx]

AL3 [A01FS]

It allows to set the full scale value for analog output 1 **independently** from the main scale of the instrument.

MENU 9 - DISPLAY

(POS. 9.1) *Language for all msn* [Language= ITA/EN] **AL1** [LLANG]

Choice of the language. There are 8 languages available: **GB** = English, **IT** = Italian, **TR** = Turkish, **PL** = Polish, **DE** = German, **FR** = French, **PT** = Portuguese, **ES** = Spanish.

(POS. 9.2) *Display refresh Frequency* [D.rate=Hz xx] **AL1** [DISRF]

Frequency of the display data update. This parameter effects only the display layout and not the response time of the meter itself. The possible choices are: 1/2/5/10 Hz.

(POS. 9.3) *Partial totalizer* [Part. tot= ON] **AL2** [PTOTE]

This function enables the display of partial totalizer in visualization pages

(POS. 9.4) *Negative totalizer* [Neg. tot= ON] **AL2** [NEGTE]

This function enables the display of negative totalizer in visualization pages

(POS. 9.5) *Net totalizer* [Net. tot= ON] **AL2** [NVTTE]

This function enables the display of net totalizer in visualization pages

(POS. 9.6) *Quick start menu* [Quick start= ON] **AL2** [QSTME]

This function enables the quick start menu.

MENU 11 - FUNCTION

The following functions are activated by first pressing the "ENTER" and then the "ESC" when the screen appears "confirm" to start the function.

(POS. 11.1) Total direct totalizer reset [T+ RESET= ON] **AL3** [VTTPR]

Reset total direct totalizer for direct flow rate (+)

(POS. 11.2) Partial direct totalizer reset [P+ RESET= ON] **AL3** [VTPPR]

Reset total partial totalizer for direct flow rate (+)

(POS. 11.3) Total reverse totalizer reset [T- RESET= ON] **AL3** [VTTNR]

Reset total reverse totalizer for direct flow rate (-)

(POS. 11.4) Partial reverse totalizer reset [P- RESET= ON] **AL2** [VTPNR]

Reset partial reverse totalizer for direct flow rate (-)

(POS. 11.5) Load factory default sensor [Load sens.f.def= ON] **AL3** [LFDSD]

This function resets the parameters of the sensor factory default. To Load the saved files see function (11.7).

(POS. 11.6) Load factory default converter [Load conv.f.def= ON] **AL3** [LFDSD]

This function resets the parameters of the converter factory default. To Load the saved files see function (11.8).

(POS. 11.7) Save sensor factory default [Save sens.f.def= ON] **AL6** [SFDSD]

This function save the parameters of the sensor factory default.

(POS. 11.8) Save convert factory default [Save conv.f.def= ON] **AL6** [SFDSD]

This function loads the data from a converter to another.

(POS. 11.9) Calibration Immediate [Calibration] **AL5** [CALIC]

Perform manually a board's calibration. Press Enter and the message " EXECUTE?" will be visualized on the display then press long the key Enter to proceed. Press any other key to delete the operation.

If the sensor table is valid, the calibration is performed also when one of the following parameter has been change:

1. SENSOR DIAMETER -> Menu Sensor1
2. SENSOR MODEL -> Menu Sensor1
3. Exc. CURRENT -> Menu Sensor1
4. S. Freq. -> Menu Sensor1

To check the calibration status, active or inactive, type the command MCP Calic? and check as follows:

- CALIC = 1 calibration in progress
- CALIC = 0 calibration terminated

MENU 12 - DIAGNOSTIC

(POS. 12.1) Self Test Diagnostic [Self Test] AL3 [ATSIC]

Meter auto-test function. This function stops the normal functions of the meter and performs a complete test cycle on the measure input circuits and on the excitation generator. To activate this function, after select it, push key Enter, at the question: "CONFIRM EXEC.?" Long Push the same key to start auto-test, or any other key for delete operation. At the end of operation the converter will revert to one of the initial visualization pages. This function is automatically performed when switching on the device. This function restarts the converter.

(POS. 12.2) Sensor verify [Sens. verify] AL3 [SVERC]

This function perform a manual sensor verification (if BIV is active)

(POS. 12.3) Flow rate simulation [Flow sim=ON] AL3 [MSIEN]

Flow rate simulation enabling. With this function it is possible to generate an internal signal that simulates the flow rate, allowing the outputs and all the connected instruments test.

After enabling it, a '▲▼' appears in the top left of the screen and the flow rate simulation can be:

- set: by pushing the key Enter from one of visualization pages, to set the required % flow rate (Fl. rate=%) and the same key to confirm the value;
- finished: by pushing the key Enter from visualization pages and then by long pushing the same key.

(POS. 12.4) Diagnostic measures [Display measures] AL5 DMVLS

This Function shows the values of the various internal parameters as listed below :

```

UCPU:U          5.01  LFN_COM:U      0.0000
UPS:U           5.41  LFN_DIF:U      0.0000
UUSB:U          4.53  HFN_ADC:MU     0.0000
+AUCC:U        +10.1  LFN_ADC:MU     0.0001
-AUCC:U         -9.9  MEAS_NB:      0.0000
UBATT:U         0.000  CAL_I:MU       16.5030
IBATT:A         0.000  CAL_U:MU       530.7778
VIN1:U          -8.071  CAL_G:MU       320.1622
VIN2:U          -8.065  CAL_O:MA       -0.0555
VIN_C:U         -8.068  CAL_C:MA       -0.0555
VIN_D:U         -8.006  CAL_R0:        1.000000
C-C:MA         25.00  CAL_R1:        1.000000
C-U:U           5.0  CAL_R2:        1.000000
C-UPK:U         5.5  CAL_R3:        1.000000
C-R:Ω          201.9  SVS_F:MHz     0.0000
C-PWR:W         0.126  CURR_K:        0.0000
C-T:°C          - - -  PROC1:%%      46.4
C-RT:ms         0.00  PROC2:%%      29.3
C-LK:MA         0.000  PROC3:%%      12.1
C-ST:           1  PROC4:%%      12.1
S-UER, RSLT:    0000  PROC5:%%      12.1
E1R:KA          0.0  CPU_T:°C      +33.12
E2R:KA          0.0
    
```

(POS. 12.5) Disp, comm. Diagnostic values [Disp. comm. vars] AL5 DCVLS

Create a list of diagnostic values on the instrument communication.

```

PPP link status → PPP_STATUS: NETW E_IP_HDR5: 3
MCPI socket status → MCPI_S: ESTABLISH E_IP_HDR6: 0
RxCNT: 1477149 E_IP_HDR7: 0
TxCNT: 6515456 E_IP_HDR8: 0
E_SR_LINK: 0 E_IP_HDR9: 0
E_PAKTLEN: 0 E_TCPHDR1: 0
E_NETLAYR: 0 E_TCPHDR2: 0
E_TSPLAYR: 0 E_UDPHDR1: 0
E_ARPHDR1: 0 E_UDPHDR2: 0
E_ARPHDR2: 0 E_UDPHDR3: 92
E_IP_HDR1: 0 E_ICMPHDR: 0
E_IP_HDR2: 0
E_IP_HDR3: 0
E_IP_HDR4: 0
    
```

The manufacturer guarantees only English text available on our web site www.isoil.com

Following are the states for the PPP link and MCPI to connect the device.

PPP link status:

- "UNDT" = undetermined
- "DEAD" = dead, link down, persistent condition
- "LCP" = LCP phase, transition condition
- "AUTH" = Authentication phase, transition condition
- "IPCP" = IP and DNS addressess assign phase, transition condition
- "NETW" = network established (normal persistent condition when the link is UP)
- "TERM" = link termination request, transition condition

MCPI link status:

- "CLOSED" = socket closed
- "ACCEPT" = socket awaiting for new connection
- "ESTABLISH" = link established
- "CLS_WAIT" = waiting for closure
- "LAST_ACK" = lask ACK sent
- "FIN_WAIT" = (see TCP/IP RFC documentation)
- "TIME_WAIT" = (see TCP/IP RFC documentation)

The manufacturer guarantees only English text available on our web site www.isoil.com

(POS. 12.6) Display graphs [Display graphs] AL5 NO MCP COMMAND

This function displays graphs of input Z, C. current, C. Volt, C.Load, Input 1, Input 2, Input1-Input 2, Analog to Digital Converter.

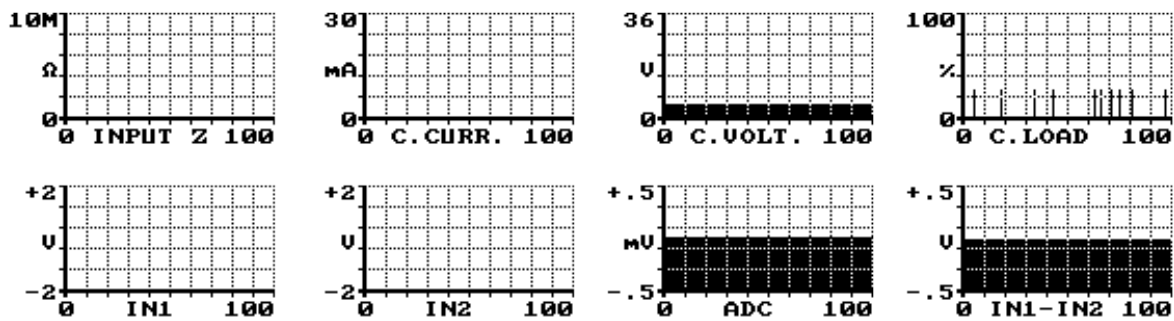

(POS. 12.7) Firmware info [Firmware info] AL0 MODSV

Firmware info version/revision

```

MU110
U. 0.00.1403.FFFF
Apr 22 2016
12:35:47
    
```

(POS. 12.8) Board Serial Number [S/N= xxxxxx] **ALO** [SRNUM?]

View Board serial number. (read only)

(POS. 12.9) Working Time [WT= xxxx: xx: xx: xx] **ALO** [TWKTM?]

View Total working time instrument. (read only)

MENU 12 - DIAGNOSTIC: ONLY MCP FUNCTIONS

Diagnostic function [MCP ONLY] **ALO** [DIAGF?]

Reserved to the service

Coil Current Mean Real Value [MCP ONLY] **ALO** [CCMRV?]

Reserved to the service

MENU 13 - SYSTEM

(POS. 13.1-2-3-4-5-6) Access level n° code [Ln xxxxxxxx] --- [L1ACD]-> [L6ACD]

This function enables or disables, for each access level code, the main menu functions.
 Each level unlocks the functionality of the lower level. (Function "13.7 Restricted access level")
 L1 code= ***** Access level value code 1 L4 code= ***** Access level value code 4
 L2 code= ***** Access level value code 2 L5 code= ***** Access level value code 5
 L3 code= ***** Access level value code 3 L6 code= ***** Access level value code 6

(POS. 13.7) Restricted access level [Restr. access= ON] **AL6** [RSARE]

Enable Or disable access level code. If active displays only the functions related to the level entered access.

IP ADDRESS SETTING (13.8-9-10)

(POS. 13.8) Device IP address [XXX.XXX.XXX.XXX] **AL3** [DIPAD]

Device IP network edress

(POS. 13.9) Client IP address [XXX.XXX.XXX.XXX] **AL3** [CIPAD]

Client IP network adress

(POS. 13.10) Network mask [XXX.XXX.XXX.XXX] **AL3** [NETMS]

Network mask.

Caution: Changes to the functions of the points 13.11-13.12-13.13 are enabled after the drive device restart (see function 12.1 Self test for restart converter).

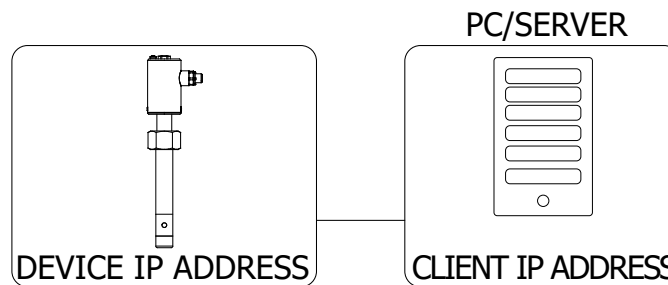

(POS. 13.11) Coefficient KT [KF=X.XXXXX] **AL6** [CFFKT]

Gain correction coefficient (calculated automatically)

(POS. 13.12) Coefficient KS [KF=X.XXXXX] **AL5** [CFFKS]

Correction coefficient constant instrumental

(POS. 13.13) Coefficient KR [KR=X.XXXXX] **AL5** [CFFKR]

Correction coefficient constant instrumental

DIGITAL ANALOG CONVERTER (Correction Parameters)(13.14-15)

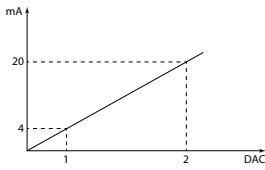

The diagram shows how the DAC4-20mA parameters are setup. The DAC1 value corresponds to 4 mA corresponding to a zero flow rate, while the value of 20mA corresponds to a 100% of the flow rate.

(POS. 13.14) DAC1 4mA	[DAC1 4mA =XXXXX]	AL5	[C1CP1]
------------------------------	--------------------------	------------	----------------

DAC1 out 4mA calibration point. (current output1 calibration point 1)

(POS. 13.15) DAC1 20mA	[DAC1 20mA=XXXXX]	AL5	[C1CP2]
-------------------------------	--------------------------	------------	----------------

DAC1 out 20mA calibration point. (current output1 calibration point 2)

(POS. 13.16) Firmware Update	[FW update]	AL4	[FWUPD]
-------------------------------------	--------------------	------------	----------------

Enable firmware update. The firmware can be upload to the SD card (name.file).
MCP interface is activated by the command FWUPD = name.file

MENU 13 - SYSTEM: ONLY MCP FUNCTIONS

Unique Identity KEY	[MCP ONLY]	AL0	[UIKEY]
Device Unique Identity key			
HardWare SET	[MCP ONLY]	AL0	[HWSET]
Device hardware configuration			
HardWare CODE	[MCP ONLY]	AL0	[HWCOD]
Device hardware code			
Calibr. Exec. status Memory	[MCP ONLY]	AL6	[CALXM]
Calibration Execution status Memory. This function checks the instrument's internal calibration status. CALXM=1 valid calibration in execution. CALXM=0 invalid calibration (If the function is zero, start the calibration function [MCP command CALIC])			
Function CODE Selection	[MCP ONLY]	AL0	[FCODS]
Select the function code			
FuNction Enable State Selection	[MCP ONLY]	AL6	[FNESS]
Select the enable state of function			
All FuNctions State Selection	[MCP ONLY]	AL6	[AFNSS]
Select enable state of ALL function			
Quick Start FuNction Selection	[MCP ONLY]	AL6	[QSFNS]
Select function for quick start menu			
Quick Start All Functions Selection	[MCP ONLY]	AL6	[QSAFS]
Select ALL function converter for quick start menu.			
Quick start function Status LiST	[MCP ONLY]	AL6	[QSLST]
List quick start group functions			
Function enable Status LiST	[MCP ONLY]	AL6	[FSLST]
List enable status of functions			

Access CODE [MCP ONLY] *AL0* [ACODE]

Input the right access code

Exemple set quick start menù function for mcp.

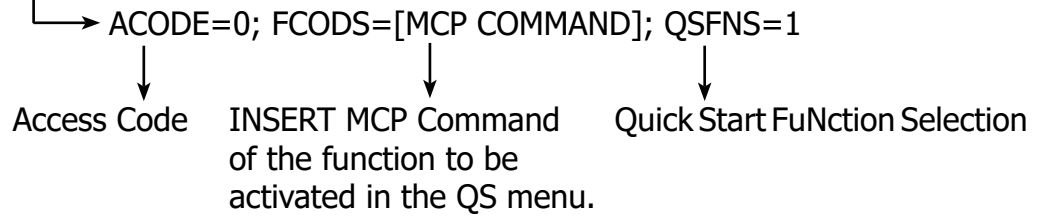
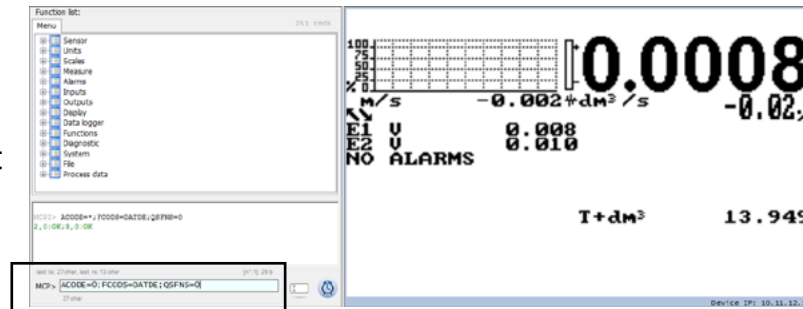

LINK Terminate [MCP ONLY] *AL0* [LTERM]

Terminate the PPP data link

MCPI session QUIT [MCP ONLY] *AL0* [MQUIT]

Quit the MCPI connection

Functions LIST [MCP ONLY] *AL0* [FLIST]

View list of all available converter functions.

Functions LISt Compact [MCP ONLY] *AL0* [FLISC]

View compact list of all available converter functions.

Functions Menu SElection [MCP ONLY] *AL0* [FMSEL]

Select menu for functions list

ConFiguRation LISt [MCP ONLY] *AL0* [CFLST]

Configuration parameter list. The list with the status / values of the converter parameter.

Volume Totalizer Total Positive Set [MCP ONLY] *AL4* [VTTPS]

Totaliz.T+ value set

Volume Totalizer Partial Positive Set [MCP ONLY] *AL4* [VTPPS]

Totaliz.P+ value set

<i>Volume Totalizer Total Negative Set</i> Totaliz.T- value set	[MCP ONLY]	AL4	[VTTNS]
<i>Volume Totalizer Partial Negative Set</i> Totaliz.P- value set	[MCP ONLY]	AL4	[VTPNS]
<i>Volume Total Positive Overflow Set</i> Totaliz.T+ overflow value set	[MCP ONLY]	AL4	[VTPOS]
<i>Volume Partial Positive Overflow Set</i> Totaliz.P+ overflow value set	[MCP ONLY]	AL4	[VPPOS]
<i>Volume Total Negative Overflow Set</i> Totaliz.T- overflow value set	[MCP ONLY]	AL4	[VTNOS]
<i>Volume Partial Negative Overflow Set</i> Totaliz.P- overflow value set	[MCP ONLY]	AL4	[VPNOS]
<i>CPU MaX.recorded temperature</i> CPU max.recorded temperature	[MCP ONLY]	AL6	[CPUMX]
<i>CPU MiN.recorded temperature</i> CPU min.recorded temperature	[MCP ONLY]	AL6	[CPUMN]
<i>Calibration OFset Register 0</i> Calibration offset register 0	[MCP ONLY]	AL6	[COFR0]
<i>Calibration GAin Register 0</i> Calibration gain register 0	[MCP ONLY]	AL6	[CGAR0]
<i>Calibration GAin Register 1</i> Calibration gain register 1	[MCP ONLY]	AL6	[CGAR1]
<i>Calibration GAin Register C</i> Calibration gain register C	[MCP ONLY]	AL6	[CGARC]

MENU 15 - PROCESS DATA (ONLY MCP)

<i>OUTput 1 Set</i>	[MCP ONLY]	<i>AL0</i>	[OUT1S]
Set value for digital output 1			
<i>OUTput 2 Set</i>	[MCP ONLY]	<i>AL0</i>	[OUT2S]
Set value for digital output 2			
<i>Flow Rate Full Scale in chosen Units</i>	[MCP ONLY]	<i>AL0</i>	[FRFSU]
F.rate f.scale in chosen units			
<i>Flow Rate Scale Range Number</i>	[MCP ONLY]	<i>AL0</i>	[FRSRN]
Working Scale number			
<i>Flow Rate Value PerCentage</i>	[MCP ONLY]	<i>AL0</i>	[FRVPC]
Flow rate value in percentage			
<i>Flow Rate Value Percentage without cut-off</i>	[MCP ONLY]	<i>AL0</i>	[FRVPX]
F.rate in perc.without cut-off			
<i>Flow Rate Value Binary without cut-off</i>	[MCP ONLY]	<i>AL0</i>	[FRVBX]
F.rate in binary.without cut-off			
<i>Flow Rate Value Technical Unit</i>	[MCP ONLY]	<i>AL0</i>	[FRVTU]
F.rate value in unit of measure			
<i>Volume Totalizer Total Positive Value</i>	[MCP ONLY]	<i>AL0</i>	[VTTTPV]
Totaliz.T+ read value			
<i>Volume Totalizer Partial Positive Value</i>	[MCP ONLY]	<i>AL0</i>	[VTPPV]
Totaliz.P+ read value			
<i>Volume Totalizer Total Negative Value</i>	[MCP ONLY]	<i>AL0</i>	[VTTNV]
Totaliz.T- read value			
<i>Volume Totalizer Partial Negative Value</i>	[MCP ONLY]	<i>AL0</i>	[VTPNV]
Totaliz.P- read value			
<i>Volume Totalizer Total Positive Overflow</i>	[MCP ONLY]	<i>AL0</i>	[VTTPO]
Totaliz.T+ number of overflows			
<i>Volume Totalizer Partial Positive Overflow</i>	[MCP ONLY]	<i>AL0</i>	[VTPPO]
Totaliz.P+ number of overflows			
<i>Volume Totalizer Total Negative Overflow</i>	[MCP ONLY]	<i>AL0</i>	[VTTNO]
Totaliz.T- number of overflows			

<i>Volume Totalizer Partial Negative Overflow</i>	[MCP ONLY]	ALO	[VTPNO]
Totaliz.P- number of overflows			
<i>T1 temperature Value in Unit of measure</i>	[MCP ONLY]	ALO	[T1VUM]
Detected liquid temperature in chosen measure unit			
<i>T1 temperature Value in PerCentage</i>	[MCP ONLY]	ALO	[T1VPC]
Detected liquid temperature in full scale percentage			
<i>LiQuid VELOCITY</i>	[MCP ONLY]	ALO	[LQVEL]
Liquid velocity			
<i>ALARM status</i>	[MCP ONLY]	ALO	[ALARM]
Active alarm(s) status			
<i>Sensor TeSt Result Code</i>	[MCP ONLY]	ALO	[STSRC]
Sensor test result code			
<i>CPU temperature</i>	[MCP ONLY]	ALO	[CPUTP]
CPU temperature			
<i>Main power status</i>	[MCP ONLY]	ALO	[MPWRS]
Status of main power supply			
<i>INput RESistance</i>	[MCP ONLY]	ALO	[INRES]
Equivalent Input resistance			
<i>INput VoLtageS</i>	[MCP ONLY]	ALO	[INVLS]
Electrodes input voltages			
<i>SEquence NumBer</i>	[MCP ONLY]	ALO	[SEQNB]
Sequence number			
<i>Sensor Table version</i>	[MCP ONLY]	ALO	[STBLV]
Reserved to the service			

ALARM MESSAGES (CAUSES AND ACTIONS TO BE TAKEN)

MESSAGGIO	CAUSE	ACTION TO TAKE
NO ALARMS	All works regularly	---
[000] SYSTEM RESTART	---	---
[001] INTERNAL PS FAIL	Internal supply voltage error	Contact the service
[005] F-RAM ERROR	Error writing / reading Flash-RAM	Contact the service
[006] EXCITATION ERROR	The excitation of the sensor coils resulting from cable is interrupted	Check the connecting cables to the sensor.
[007] SIGNAL ERROR	The measure is strongly effected by external noise or the cable connecting the converter to the sensor is broken.	Check the status of the cables connecting the sensor, the grounding connections of the devices and the possible presence of noise sources.
[008] PIPE EMPTY	The measuring pipe is empty or the detection system has not been properly calibrated.	Check whether the pipe is empty or repeat the empty pipe calibration procedure.
[009] FLOW>MAX+	The flow rate is higher than the maximum positive threshold set.	Check the maximum positive flow rate threshold set and the process conditions.
[010] FLOW>MAX-	The flow rate is higher than the maximum negative threshold set.	Check the maximum negative flow rate threshold set and the process conditions.
[011] FLOW<MIN+	The flow rate is lower than the minimum positive threshold set.	Check the minimum positive flow rate threshold set and the process conditions.
[012] FLOW<MIN-	The flow rate is lower than the minimum negative threshold set.	Check the minimum negative flow rate threshold set and the process conditions.
[013] FLOW>FULL SCALE+	The flow rate is higher than the full scale positive value set on the instrument.	Check the full scale positive value set on the instrument and the process conditions.
[014] FLOW>FULL SCALE-	The flow rate is higher than the full scale negative value set on the instrument.	Check the full scale negative value set on the instrument and the process conditions.
[015] PULSE1>RANGE	The pulse generation output 1 of the device is saturated and cannot generate the sufficient number of impulses.	Set a bigger unit of volume or, if the connected counting device allows it, reduce the pulse duration value.
[016] PULSE2>RANGE	The pulse generation output 2 of the device is saturated and cannot generate the sufficient number of impulses.	Set a bigger unit of volume or, if the connected counting device allows it, reduce the pulse duration value.
[017] CALIBR.ERROR	Calibration Error	Contact the service
[018] SYSTEM FREQ.ERR	System Freq. Error	Contact the service
[019] B.DATA NOT INIT	Uninitialized data system	Contact the service
[020] FL.SENSOR ERROR	Flow rate sensor error	Contact the service
[024] MAIN PS V.ERR	Main supply voltage (+ 5V) out of tolerance.	Contact the service
[025] USB VOLTAGE ERR	Voltage of USB connection out of tolerance.	Contact the service

ERROR CODE TEST SYSTEM OF SENSOR

The codes are in hexadecimal format, the meaning is given for each bit. There are several possible error simultaneous combinations (more bits active) then that will give the combined numerical codes.

CODE	ANOMALIES DESCRIPTION	ACTION TO TAKE
0000	NO ERROR	---
0001	SENSOR TEST INSULATION: Generator power too low	Contact the service
0002	SENSOR TEST INSULATION: Generator power too high	
0004	SENSOR TEST INSULATION: Phase 1 generator voltage too low	
0008	SENSOR TEST INSULATION: Phase 1 generator voltage too high	
0010	SENSOR TEST INSULATION: Phase 1 terminal voltage coils 1 too low	
0020	SENSOR TEST INSULATION: Phase 1 terminal voltage coils 2 too low	
0040	SENSOR TEST INSULATION: Phase 2 generator voltage too low	
0080	SENSOR TEST INSULATION: Phase 2 generator voltage too high	
0100	SENSOR TEST INSULATION: Phase 2 terminal voltage coils 1 too low	
0200	SENSOR TEST INSULATION: Phase 2 terminal voltage coils 2 too low	
0400	SENSOR TEST INSULATION: Insulation loss, leakage current out of tolerance	Check: <input type="checkbox"/> wiring between sensor converter <input type="checkbox"/> conditions of use <input type="checkbox"/> set parameters If the problem persists contact the service
0800	TEST TEMPERATURE (RESISTANCE) COILS: Temperature (resistance) out of tolerance	
1000	TEST TIME GETTING ON CURRENT PHASE (A): Value out of tolerance	
2000	TEST TIME GETTING ON CURRENT PHASE (B): Value out of tolerance	
4000	TEST RESISTANCE INPUTS ELECTRODES: Input value 1 out of tolerance	
8000	TEST RESISTANCE INPUTS ELECTRODES: Input value 1 out of tolerance	

The manufacturer guarantees only English text available on our web site www.isoli.com

MANUAL REVIEWS

REVIEW	DATE	DESCRIPTION
CS3795_IT_EN_R0_1.00.0	14/02/2018	First edition

At the end of its lifetime, this product shall be disposed of in full compliance with the environmental regulations of the state in which it is located.





ISOIL INDUSTRIA S.p.A.

HEAD OFFICE	SERVICE
Via Fratelli Gracchi, 27 20092 Cinisello Balsamo (MI) Tel +39 02 66027.1 Fax +39 02 6123202 vendite@isoil.it	isomagservice@isoil.it

If you want to find the complete list of our distributors access at the following link:
http://www.isoil.com/u_vendita.asp



Due to the constant technical development and improvement of its products, the manufacturer reserves the right to make changes and/or modify the information contained in this document without notice.