

Truflo® — UltraFlo® UF-500 Clamp-On Ultrasonic Flow Meter Sensor

ICON™ Corrosion-Free
PROCESS CONTROLS Instrumentation Equipment

Flow | Total | Pulse | 4-20mA | RS485 | IO-Link

**Ultra-Convenient,
Ultra-Simple,
Ultra-Versatile**
— **UltraFlo®**



truflo®

Convenience, Accuracy and Value in an Ultrasonic Flow Meter

Truflo® — UltraFlo® UF-500

Clamp-On Ultrasonic Flow Meter Sensor

Ultra-Convenient, Ultra-Simple, Ultra-Versatile — UltraFlo®

- ✓ Under 2 Minute Installation Time
- ✓ No Contact with Liquid
- ✓ No Moving Parts
- ✓ Simple to Install-No Cutting of Pipe
- ✓ Works on Carbon Steel | Stainless Steel | PVC | Copper | PVDF | PFA | PTFE | PU | Aluminium
- ✓ Pulse | 4-20mA | RS485 Output
- ✓ Flow Rate + Totalizer | Resettable
- ✓ Simple Programming
- ✓ Large Blue OLED Low Light Display



Convenience, Accuracy and Value in an Ultrasonic Flow Meter

The Truflo® UF500 series clamp-on ultrasonic flow meters are easy to install with exceptional long life performance and they require no alteration to current piping configurations.

The sensor sends over 50 pulses/sec in order to provide accurate measurement of liquid flow rates in full pipes and can be used in low pressure systems.

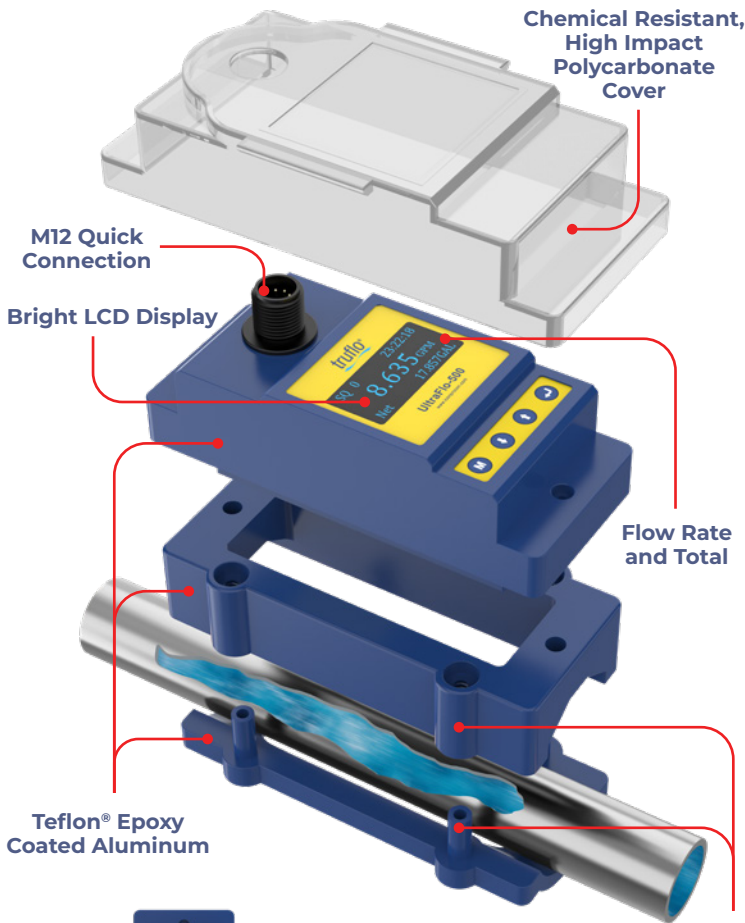

- ✓ Wide Dynamic Flow Range of 0.3 to 15 ft/s | 0.1 to 5 m/s
- ✓ High Accuracy | ± 2.0% of Full Scale
- ✓ Pipe Sizes ½ – 6"
- ✓ Lightweight
- ✓ Excellent External Corrosion Resistance
- ✓ Data Logging (day, month, year)
- ✓ Suitable for RO/DI Systems

Flow Rate/Net Totalizer	
SQ99	12:30:18
14.8 GPM	
Net	9003 GAL

Run Time/Daily Totalizer /Month Totalizer/Year Totalizer	
Runtime	216h
Day	20887 GAL
Mth.	646992 GAL
Year	7488505 GAL

Flow Rate/S.ToT Totalizer	
SQ99	12:30:18
14.8 GPM	
S.ToT	6311.1 GAL

See page 3 for a detailed display description

Flow Rate/Velocity /Net Totalizer	
SQ99	12:30:18
Vel	3.8 f/s
Flow	895.2 GPM
Net	203119 gal

Velocity/Net Totalizer	
20-03-23	12:30
27.7 f/s	
Net	6311.1 gal



truflo®

Teflon® Epoxy Coated Aluminum



Magnetic Connection (for easier installation)

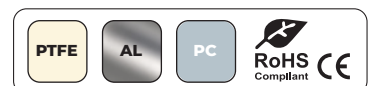

Truflo® — UltraFlo® UF-500

Clamp-On Ultrasonic Flow Meter Sensor

General

Operating Range	0.3 – 15 ft/s	0.1 – 5 m/s
Pipe Size Range	½ – 6"	DN15 – DN100
Temperature Range	32 – 122°F	0 – 50°C
	32 – 302°F (HT model)	0 – 150°C (HT model)
Repeatability	±0.8% of max. range @ 25 °C (77 °F)	
Linearity	±2.0% of max. range @ 25 °C (77 °F)	
Output	Pulse 4-20mA RS485	

Materials

Sensor Body	Teflon® Epoxy Coated Aluminum
-------------	-------------------------------

Electronics

Power Supply	24 VDC
Connection	M12

Display

LCD 128 * 64 Dot Matrix

Totalizer Units

6-Digit Accumulator

Standards and Approvals

CE FCC
RoHS Compliant

Measuring Points

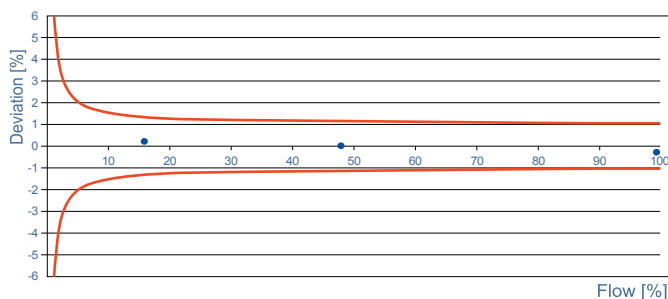

Other Considerations

Ensure Proper Installation

Proper installation plays a crucial role in ensuring the accuracy of an ultrasonic flow meter. Any errors or misalignments during installation can lead to inaccurate measurements. The UF-500 is designed with ease of installation in mind. Installation time is typically less than two minutes.

Installation Location

Selecting an appropriate location away from disturbances such as bends, valves, or pipe irregularities is essential as it can effect flow profile.

Flow Profile

The flow profile refers to the velocity distribution across the pipe's cross-section. If the flow profile is not uniform, the accuracy of the ultrasonic flow meter can be compromised. Factors such as bends, valves, or obstructions in the pipe can cause variations in the flow profile. The flow meter's accuracy can be improved by ensuring a smooth and fully developed flow profile.

Transducer Care

The transducers are the key components of an ultrasonic flow meter that emit and receive ultrasonic signals. The transducer surface should be free from air bubbles, dirt, or deposits which can interfere with the ultrasonic signal.

Signal Interference

External factors can introduce signal interference, affecting the flow meter's accuracy. Electrical equipment, nearby machinery, or electromagnetic fields can disrupt the ultrasonic signals. Shielding the flow meter from these interferences or relocating it to a less disruptive environment can help mitigate inaccuracies caused by signal interference.

Pipe Conditions and Material

The condition and material of the pipe through which the liquid flows can impact the accuracy of the ultrasonic flow meter. Irregularities in the pipe, such as corrosion, scaling, or rough surfaces, can cause signal reflections or attenuations, leading to inaccuracies. It is important to regularly inspect the pipe and address any issues promptly to maintain accurate measurements.

Truflo® — UltraFlo® UF-500

Clamp-On Ultrasonic Flow Meter Sensor

Display Layout

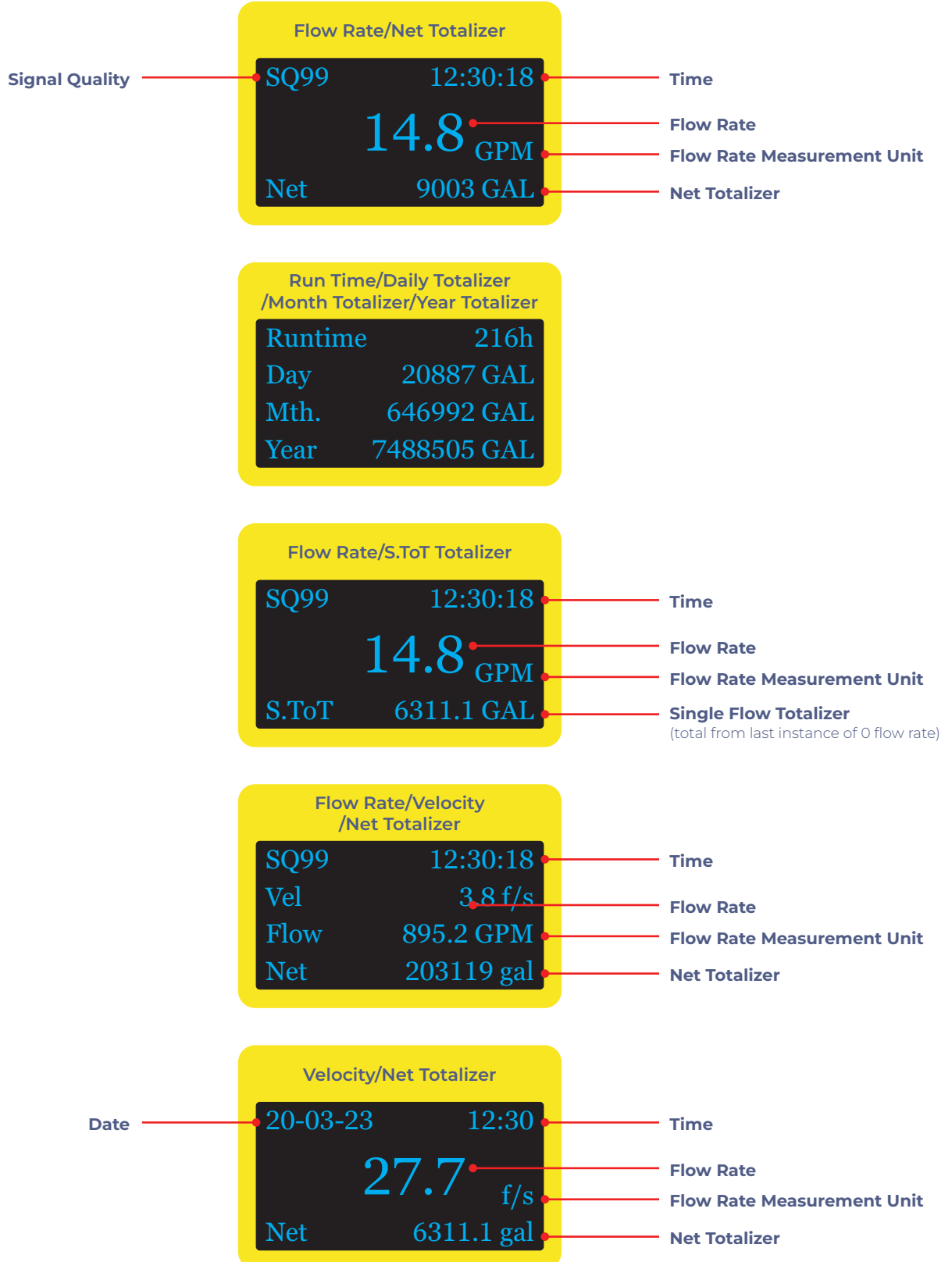

Truflo® — UltraFlo® UF-500

Clamp-On Ultrasonic Flow Meter Sensor

Outside Dimension

Pipe/Tube Size (mm)	ASME/ANSI	½"	¾"	1"	1 ¼"	1½"	2"	2½"	3"	4"
OD min		16.5	23	28	35	45	58	72	80	108
OD		20	25	32	40	50	63	75	90	110
OD max		23	28	35	45	54	68	78	92	116

Minimum Flow Range

Size ASME/ANSI	½"	¾"	1"	1 ¼"	1½"	2"	2½"	3"	4"	
Flow Range (L/min)	0.03m/s	0.57L/min	0.88L/min	1.45L/min	2.26L/min	3.53L/min	5.61L/min	7.95L/min	11.45L/min	17.1L/min
	0.5m/s	9.4L/min	14.7L/min	24.1L/min	37.7L/min	58.9L/min	93.5L/min	132.5L/min	190.9L/min	285.1L/min
	1.5m/s	28.3L/min	44.2L/min	72.4L/min	113.1L/min	176.7L/min	280.5L/min	397L/min	572.6L/min	855.3L/min
	5m/s	94.2L/min	147.2L/min	241.2L/min	376.9L/min	588.9L/min	934.9L/min	1325.4L/min	1908.5L/min	2851L/min
Flow Range (Gal/min)	0.03m/s	0.13Gal/min	0.19Gal/min	0.32Gal/min	0.5Gal/min	0.78Gal/min	1.23Gal/min	1.75Gal/min	2.52Gal/min	3.76Gal/min
	0.5m/s	2.07Gal/min	3.23Gal/min	5.3Gal/min	8.29Gal/min	12.96Gal/min	20.57Gal/min	29.15Gal/min	41.99Gal/min	62.71Gal/min
	1.5m/s	6.23Gal/min	9.72Gal/min	15.93Gal/min	24.88Gal/min	38.87Gal/min	61.70Gal/min	87.33Gal/min	125.95Gal/min	188.14Gal/min
	5m/s	20.72Gal/min	32.38Gal/min	53.06Gal/min	82.91Gal/min	129.54Gal/min	205.65Gal/min	291.55Gal/min	419.81Gal/min	627.13Gal/min

Working Principle

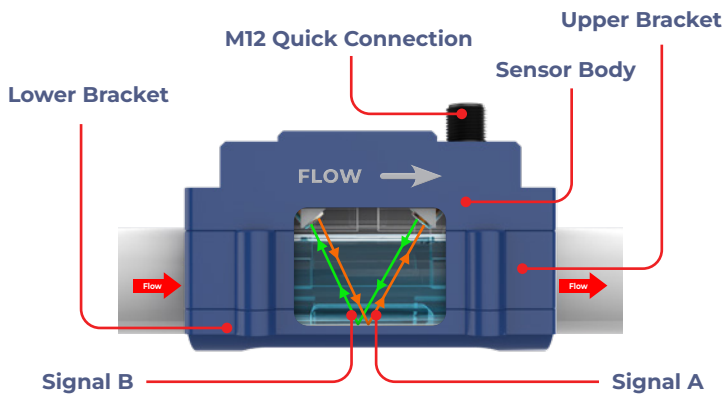

Application Example

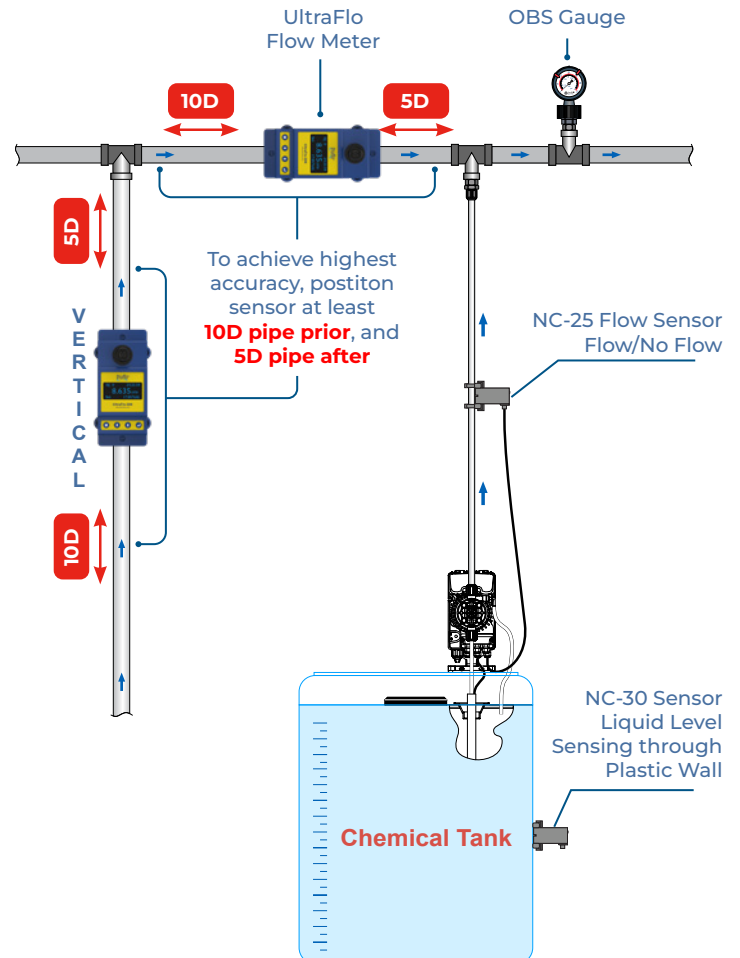

Model Selection

UltraFlo 500 — Clamp-On Ultrasonic Flow Meter		
Size	Part Number	Material
½"	UF500-A-15	Teflon® Epoxy Coated Aluminum
¾"	UF500-A-20	Teflon® Epoxy Coated Aluminum
1"	UF500-A-25	Teflon® Epoxy Coated Aluminum
1 ½"	UF500-A-40	Teflon® Epoxy Coated Aluminum
2"	UF500-A-50	Teflon® Epoxy Coated Aluminum
3"	UF500-A-80	Teflon® Epoxy Coated Aluminum
4"	UF500-A-100	Teflon® Epoxy Coated Aluminum
6"	UF500-A-150	Teflon® Epoxy Coated Aluminum

Add Suffix -
'P' - Pulse Output
'HT' - High Temperature

Installation Positions

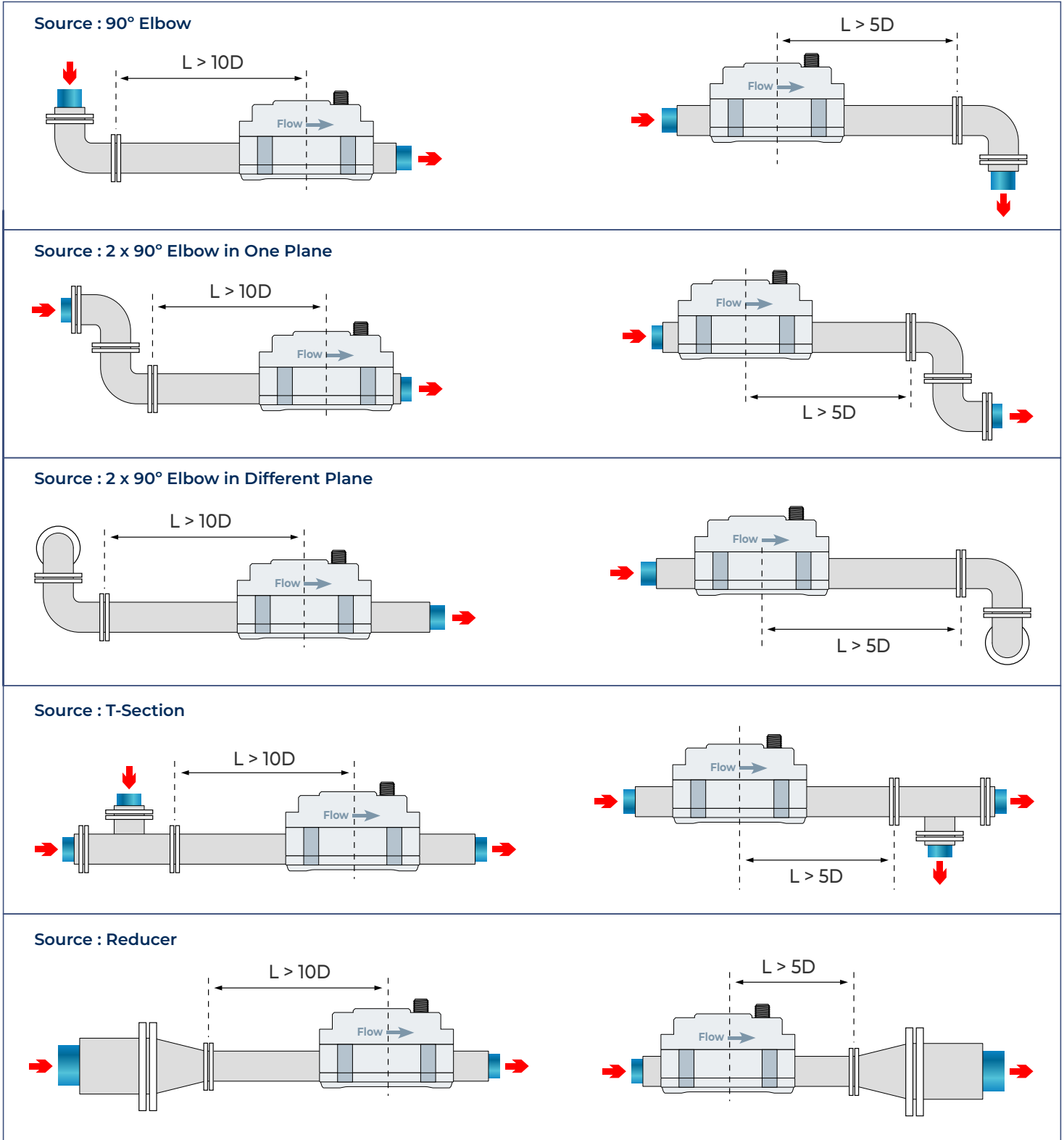

Truflo® — UltraFlo® UF-500

Clamp-On Ultrasonic Flow Meter Sensor

Installation Positions

