

LAKWOOD INSTRUMENTS™
MODEL 1575e

**WATER TREATMENT SYSTEM
CONDUCTIVITY CONTROLLER**

INSTALLATION & OPERATION MANUAL

SERIAL #: _____



Lakewood Instruments

*7838 North Faulkner Road, Milwaukee, WI 53224 USA
Phone (800) 228-0839 • Fax (414) 355-3508
<http://www.lakewoodinstruments.com>*

Lakewood Instruments™ Model 1575e Controller

Quick Installation Sheet

1. Remove the front cover from the Model 1575e Controller. For easy installation, remove the ribbon cable on the front panel keypad from the circuit board. Note cable alignment for reinstallation.
2. Install the controller on a flat, non-vibrating surface. Use the four (4) outer holes on the enclosure or use the supplied mounting feet. Do not mount the controller to a steel object that has a large temperature change (side of cooling tower, etc). This can cause water to condense inside the enclosure.
3. Install water meters, chemical pumps, plumbing assemblies and the conductivity sensor (see drawing on back for cooling tower).
4. Wire the flow switch (use jumper wire for no flow switch), conductivity sensor, water meters and 4-20 mA output/input, if applicable (see drawing on back). Ensure wiring connections are correct or damage may occur.
5. If doing a conduit installation, remove receptacles and wire pumps and bleed valve directly to the terminals. If using a motorized ball valve, wire as per wiring instructions. Refer to the instruction manual for more details.
6. Reinstall the front cover keypad making sure the ribbon cable is properly attached (with no exposed pins on either side of the connector).
7. Plug in chemical pumps and bleed valve to controller (unless hardwired as per step #5).
8. Apply power to the 1575e controller, press "CLR" twice, press "7" System setup, press "2" Initialization, press "2" Whole controller, press "1" Yes. After initialization, press the "CLR" key several times until you get to the main menu.
9. Press "1" Process, Press "ENT". This screen allows manual control of the relay outputs to test the chemical pumps and bleed valve. Press "CLR" to return to the Process screen.
10. Press "CLR" to get to the main menu. Press "7" System Setup, press "1" Process Parameters, press "1" Cell Constant, input the cell constant for your sensor, press "ENT" to return to the Process Parameter screen. Press "2" Temp Compensation, select the temperature compensator for your sensor. Press "CLR" several times to return to the main menu, press "1" for the Process screen. Enable the 4-20mA input if applicable.
11. To calibrate conductivity take a sample with a handheld conductivity meter, press the "PRO" button, type in conductivity value, press "ENT" (skip if not using conductivity sensor or see instruction manual for more details.).
12. Program the 1575e relays for bleed and chemical feed schemes. If no conductivity sensor is used, disable the conductivity input. See instruction manual for more details.

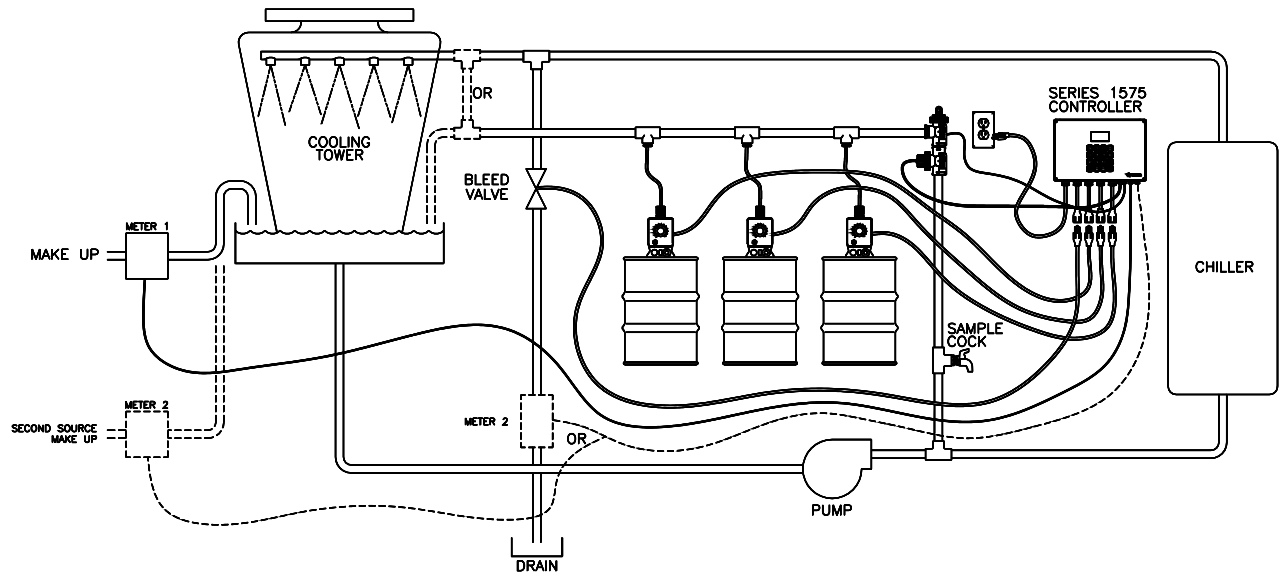

NOTES: UNLESS OTHERWISE SPECIFIED;
 ⚠ IF NO FLOW SWITCH IS USED, SHORT OUT PINS 1 & 2 WITH WIRE.

| REVISION | | REVISION HISTORY | | |
|----------|------|------------------|------|-------------|
| DWG | PART | DESCRIPTION | EDD | APV/DATE |
| A | A | RELEASE | 6377 | DKK/23JAN02 |

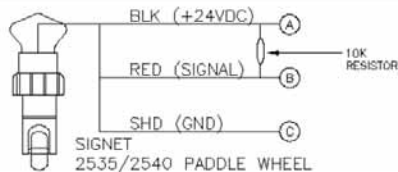
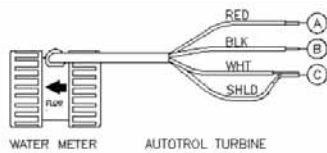
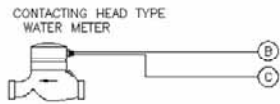
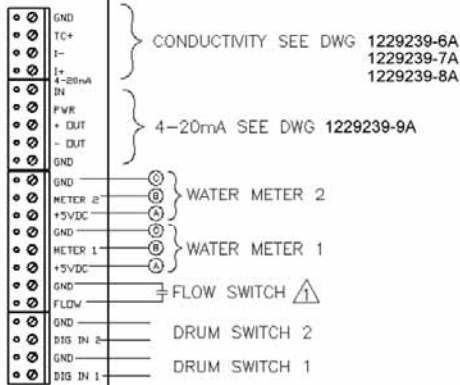

NOTICE ON REPRODUCTIONS
 THIS DRAWING, THE DESIGN AND THE PATENT RIGHTS THEREIN, ARE THE PROPERTY OF
 CEMCON, INC. THEY ARE LOANED TO YOU AND ON THE DRAWING'S PAPERS
 AGREEMENT THAT THEY WILL NOT BE REPRODUCED, COPIED, LOANED, ROBBED,
 AND USED EXCEPT IN THE MANNER AND THE PRIVATE USE PERMITTED BY
 WRITTEN CONSENT GIVEN BY THE LENDER TO THE BORROWER.

| MATERIAL | | TOLERANCES UNLESS NOTED | | TITLE | |
|----------|-------|-------------------------|-----------|--------------------------|---------------------------|
| NA | SCALE | EXAMPLE | FIELDS | WIRING DIAGRAM FOR WATER | METER INPUTS ON THE 1575e |
| | | .XX ± | ± | SIZE | PN |
| | | .XXX ± | ± SURFACE | B | 1229239 |
| FINISH | N/A | OWN DSK | DATE | SCALE | SHEET |
| | | CHKD | DATE | 1 OF 1 | DWG NO. 1229239-5a |
| PROJECT | | APLD | DATE | NTS | REV |
| LIBRARY | | PARTY/CHURN | | | A |



IMPORTANT NOTICE

WARNING: CHEMICAL FEED

All electromechanical devices are subject to failure from a variety of causes. These include mechanical stress, component degradation, electromagnetic fields, mishandling, improper setup, physical abuse, chemical abuse, improper installation, improper power feeds, and exposure.

While every precaution is taken to insure proper functioning, extra precautions should be taken to limit the ability of over-feeding by limiting chemical quantities available, secondary shut-downs, alarms, and redundancy or other available methods.

CAUTION: POWER SOURCE AND WIRING

Low voltage wiring and high voltage (110 plus) should not be run in the same conduit. Always run separately. Even shielded low voltage is not a guarantee of isolation.

Every precaution should be taken to insure proper grounding and elimination of shorting or Electromagnetic field (EMF) interference.

WARNING: ELECTRICAL SHOCK

To reduce the risk of electrical shock, this equipment has a grounding-type plug that has a third (grounding) pin. This plug will only fit into a grounding-type outlet. If the plug does not fit into the outlet, contact a qualified electrician to install the proper outlet. **DO NOT** change the plug in any way.

Lakewood Instruments

We thank you for your selection and purchase of a Lakewood Instruments product.

With proper care and maintenance, this device should give you many years of trouble-free service. Please take the time to read and understand this Installation and Operation Manual, paying special attention to the sections on **OPERATION** and **MAINTENANCE**.

If, in the future, any parts or repairs are required, we strongly recommend that only original replacement parts be used. Our Customer Service Department is happy to assist you with your parts or service requests.

 **Lakewood Instruments Customer Service and Technical Support Departments can be reached by calling (800) 228-0839 or faxing (414) 355-3508, Monday through Friday, 7:30 a.m. - 5:00 p.m. CST.**

 **Mail should be sent to:**

**Lakewood Instruments
7838 North Faulkner Road
Milwaukee, WI 53224 USA**

MODEL 1575e

Table of Contents

| | |
|--|----|
| 1.0 Introduction | 8 |
| 2.0 Features, Benefits and Specifications | 9 |
| 2.1 Features | 9 |
| 2.2 Benefits | 10 |
| 2.3 Specifications | 10 |
| 2.4 Ordering Information..... | 12 |
| 3.0 Unpacking, Mounting and Installation | 13 |
| 3.1 Unpacking | 13 |
| 3.2 Mounting the Enclosure..... | 13 |
| 3.3 Plumbing Installation | 14 |
| 3.3.1 Cooling Tower Plumbing..... | 14 |
| 3.3.1.1 Blowdown Valve Sizing | 15 |
| 3.3.2 Boiler Plumbing..... | 16 |
| 3.3.2.1 Orifice Sizing Chart..... | 17 |
| 3.3.3 Condensate Plumbing | 17 |
| 3.3.4 Sensor Mounting..... | 17 |
| 3.4 Electrical Installation..... | 18 |
| 3.4.1 Incoming power | 18 |
| 3.4.2 Relay Outputs | 18 |
| 3.4.3 Flow Switch Wiring | 19 |
| 3.4.4 Sensor Wiring | 19 |
| 3.4.5 Water Meter Wiring..... | 20 |
| 3.4.6 Drum Switch Wiring | 20 |
| 3.4.7 4-20 mA Output Wiring | 20 |
| 3.4.8 4-20 mA Input Wiring | 20 |
| 4.0 Functional Overview | 21 |
| 4.1 Front Panel..... | 21 |
| 4.2 Display..... | 22 |
| 4.3 Keypad | 22 |
| 4.4 Menu | 22 |
| 4.5 Security Levels | 23 |
| 5.0 Starting Up the Controller..... | 23 |
| 6.0 Operation of Controller | 24 |
| 6.1 Process Screen | 24 |
| 6.2 Manual Operation of the Relays | 25 |
| 6.3 Calibration of Conductivity and the Secondary Input..... | 25 |
| 6.3.1 Calibration of On-Board Conductivity..... | 25 |
| 6.3.2 Calibration of Secondary 4-20 mA reading | 27 |
| 6.3.3 Conductivity vs. PPM..... | 28 |
| 6.4 Main Menu..... | 29 |

| | |
|--|----|
| 6.5 Configuring the Relays | 29 |
| 6.5.1 Configuring the Blowdown Relay | 30 |
| 6.5.1.1 Based on Setpoint | 30 |
| 6.5.1.1.1 Setpoint Values | 30 |
| 6.5.1.1.2 Deadband..... | 31 |
| 6.5.1.1.3 Excess Blowdown Time..... | 31 |
| 6.5.1.2 When to Blowdown..... | 32 |
| 6.5.1.3 Boiler Timers | 32 |
| 6.5.1.4 Ball Valve Delay | 33 |
| 6.5.1.5 Cycles of Concentration | 34 |
| 6.5.1.6 Based on Volume | 35 |
| 6.5.2 Configuring Relays 2,3,4..... | 36 |
| 6.5.2.1 Disabled | 36 |
| 6.5.2.2 By Setpoint..... | 37 |
| 6.5.2.2.1 Setpoint Values-Select Input | 37 |
| 6.5.2.2.2 Setpoint Values-Based on Setpoint..... | 38 |
| 6.5.2.2.3 Setpoint Values-When to Feed..... | 38 |
| 6.5.2.2.4 Setpoint Values-Trace Chemistry Control | 39 |
| 6.5.2.2.5 Setpoint Values-Trace Chemistry-Correction Factor .. | 40 |
| 6.5.2.2.6 Setpoint Values-Trace Chemistry-Percent of Time | 40 |
| 6.5.2.2.7 Setpoint Values-Trace Chemistry-When to Feed | 41 |
| 6.5.2.3 By Water Meter | 42 |
| 6.5.2.4 By Percent of Blowdown Time..... | 42 |
| 6.5.2.5 By Percent of Time | 43 |
| 6.5.2.6 By Feed Schedule | 44 |
| 6.5.2.7 As an Alarm Relay..... | 44 |
| 6.5.3 Setting Up the Feed Schedule | 45 |
| 6.5.4 Alarms | 47 |
| 6.5.5 Water Meters | 48 |
| 6.5.6 4-20 mA In/Out | 49 |
| 6.5.6.1 Setup the 4-20 mA Output..... | 49 |
| 6.5.6.2 Setup the 4-20 mA Input..... | 51 |
| 6.5.6.2.1 Enable/Disable the 4-20mA Input..... | 51 |
| 6.5.6.2.2 Set the 4-20mA Input Range | 53 |
| 6.5.6.2.3 Calibrate the 4-20mA Input..... | 53 |
| 6.5.7 The System Setup Menu | 54 |
| 6.5.7.1 Process Parameters..... | 54 |
| 6.5.7.1.1 Cell Constant..... | 54 |
| 6.5.7.1.2 Temperature Compensation..... | 55 |
| 6.5.7.1.3 Anti-flashing..... | 55 |
| 6.5.7.1.4 Enable or Disable Conductivity Input..... | 55 |
| 6.5.7.2 Initialization..... | 56 |
| 6.5.7.3 Change the Security Password | 57 |
| 6.5.7.4 Firmware Version | 57 |
| 6.5.7.5 Diagnostics..... | 58 |
| 6.5.8 Setting the Clock..... | 58 |
| 6.5.9 Changing the Security Levels | 58 |

| | |
|--|-------------|
| 7.0 Maintenance..... | 59 |
| 7.1 Sensor Maintenance..... | 59 |
| 7.2 Flow Switch Maintenance..... | 60 |
| 7.3 Replacing the Fuses..... | 61 |
| 8.0 Troubleshooting | 62 |
| 8.1 Error Messages | 62 |
| 9.0 Factory Service | 64 |
| 10.0 Drawings | |
| 10.1 Cooling tower Suggested installation | 1229239-1a |
| 10.2 Chill loop / Cooling tower suggested installation | 1229239-2a |
| 10.3 Boiler plumbing diagram | 1229239-3a |
| 10.4 Wiring diagram for power connections | 1229239-4a |
| 10.5 Wiring diagram for water meter inputs | 1229239-5a |
| 10.6 Cooling tower sensor wiring | 1229239-6a |
| 10.7 Boiler sensor wiring | 1229239-7a |
| 10.8 Condensate sensor wiring | 1229239-8a |
| 10.9 4-20 mA input and output wiring | 1229239-9a |
| 10.10 Fluorometer wiring | 1229239-11a |

1.0 Introduction

The Model 1575e is a microprocessor based, menu driven, water treatment controller designed for use in cooling towers, chill loops, boilers and condensate systems. The Model 1575e provides for conductivity tracking and control, flow monitoring and chemical injection. The Model 1575e includes a 4-20mA input that can be used for remote conductivity, or pH, or traced chemistry control, or makeup conductivity for cycles of concentration control, or as one of several other different inputs. The Model 1575e can be operated with or without the use of the conductivity input. The Model 1575e is ETL approved.

The Model 1575e uses the latest in microprocessor capability, giving the user a high level of application flexibility. A large illuminated graphics screen, multiple inputs, and an intuitive menu characterize this new technology.

Security features allow full access to programming features or restrict access to viewing only. An operator password can help ensure that only authorized personnel will operate the system.

The Model 1575e is user-friendly with a graphical screen, numeric keypad, LEDs for power, alarm and relay status. It accepts multiple inputs and is easily configured. It's a combination of reliability, accuracy, security and simplicity.

2.0 Features, Benefits, Specifications



Figure 1: Model 1575e

2.1 FEATURES

- Controller can be used for Cooling towers, Chill loops, Boilers, and Condensate systems
- Removable power cord and receptacles for conduit installations. Enclosure is rated NEMA 4X
- Four user configurable relays for conductivity control and chemical addition. These relays can be configured in multiple ways including scheduled feed for biocide addition
- Two (2) water meter inputs, two drum switch inputs, conductivity input, flow switch input, 4-20 mA output, and a 4-20 mA input are all standard features.
- Designed with a single circuit board for high reliability and lower cost.
- Large open shallow enclosure for easy wiring.
- Ball valve delay feature allows accurate control of motorized ball valves.
- Heavy-duty stainless steel domed numeric keypad and illuminated graphical display allow for quick and easy programming. Steel domed switches improve the tactile sensing and life expectancy of the keypad.
- The Model 1575e controller stores all setpoints, calibration values, and relay configurations in an EEPROM. An EEPROM does not require a battery to retain information, so if power is lost these values will be retained for years. The 1575e includes a capacitive backup device to retain information such as water meter totals, and clock and calendar information. The capacitive backup device will never need to be replaced and will hold data approximately 1 day after each power failure.

2.2 BENEFITS

- Easy to program, the Model 1575e Controller uses an intuitive menu and programs identical to the Lakewood 2000 Series controllers.
- Controller can be removed from a cooling tower and be placed in another type of application when used with the appropriate conductivity sensor and plumbing assembly.
- No add-on options. 4-20mA output, 4-20mA input, and biocide features are standard.

2.3 Specifications

Conductivity range

50-10,000 μ S for Cooling Towers; 500-8000 μ S for Boilers; 10-100 μ S for condensate.

Conductivity sensor

2 electrode

Conductivity Resolution

$\pm 10 \mu$ S (conductivity < 5000 μ S)
 $\pm 100 \mu$ S (conductivity > 5000 μ S)

Temperature comp.

Automatic (except boiler sensors)

Accuracy & repeatability

$\pm 1.0\%$ of scale

Deadband/Setpoint

User programmable

Auto/Manual outputs

Menu selectable

Keypad

16 tactile steel-dome push buttons

Display

Illuminated 128 x 64 pixel LCD

Drum Switch Inputs

2 digital contact inputs

Water meter inputs (2)

Contact head, paddle wheel or turbine

Timer

Max. blowdown time exceeded.
 Relay run time exceeded .

Input Signal

One 4-20 mA, non-isolated, internally powered Input.

Output Signal

One 4 – 20 mA, isolated or non-isolated optionally powered output for conductivity.

Output relays

3 selectable use, 1 blowdown

Relay ratings

3A each, 10A total

Power

120/240 VAC 50/60 Hz 6W

Ambient temp

32° - 140°F (0 - 60°C)

Storage temp

-4° - 150°F (0 - 60°C)

| Sensors/Plumbing | Cooling Tower | Boiler | Condensate |
|------------------|---------------------------------|---------------------------|-------------------|
| Max Pressure | 140 psi (9.65 bar) @100°F | 600 psi (41.3 bar) | 70 psi (4.8 bar) |
| Max Temp | 140°F (60°C) | 486°F (252°C) | 392°F (200°C) |
| Min flow | 1 gpm (3.785 Lpm), 5 gpm max | Varies w/orifice plate | 1 gpm (3.785 Lpm) |

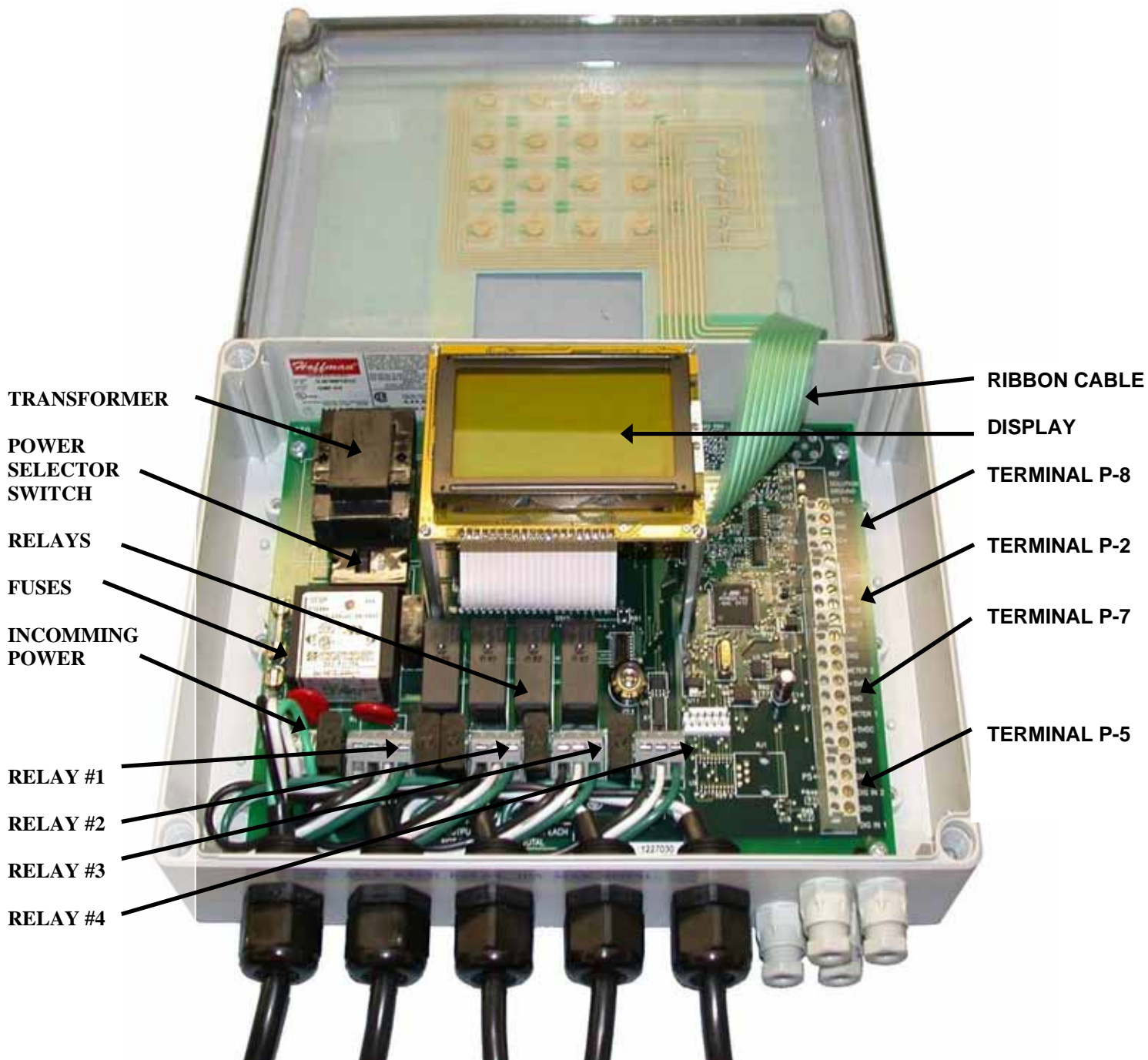

Figure 2: Model 1575e Enclosure

2.4 Ordering Information

CONTROLLER OPTIONS

1575e Water Treatment Controller. Universal controller is field programmable for cooling towers, boilers, and condensate applications.

COOLING TOWER OPTIONS

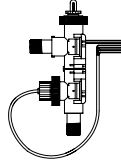

Cooling Tower Flow Switch
Plumbing w/ Sensor

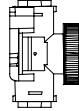

Cooling Tower Sensor Tee

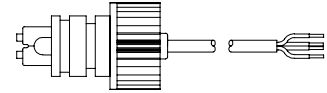

Conductivity sensor

1167158 Cooling Tower Sensor with 20 ft of cable
1167214 Plumbing Tee
1107003 Flow Switch Plumbing.

BOILER SYSTEM OPTIONS

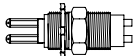

SR2

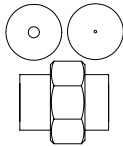

ORIFICE UNION

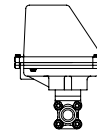

MBV1

1168374 SR2 Boiler water sensor with 20 ft cable and elbow. $\frac{3}{4}$ in NPT connection.
1166355 Orifice Plate, $\frac{1}{2}$ NPT, $\frac{1}{16}$.
1166356 Orifice Plate, $\frac{1}{2}$ NPT, $\frac{1}{4}$.
1166354 Orifice Plate, $\frac{1}{2}$ NPT, $\frac{1}{8}$.
1167972 Orifice Plate, $\frac{1}{2}$ NPT, $\frac{3}{8}$.
1167244 Orifice Union, $\frac{1}{2}$ NPT.
1166686 MBV1 $\frac{1}{2}$ in NPT Motorized ball valve.
1166687 MBV2 $\frac{3}{4}$ in NPT Motorized ball valve.

CONDENSATE OPTIONS

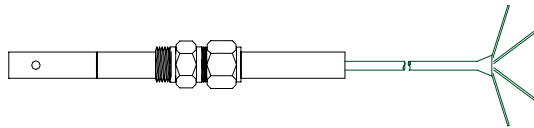

540K.1-4-10I-10-TC500

| | | |
|---------|------------------------|--|
| 1104591 | 540K.1-4-10I-10-TC500 | Condensate sensor with $\frac{3}{4}$ in NPT inline fitting. 0-100 μ S. |
| 1168617 | 540K.1-4-10R-18-TC500 | Condensate sensor with 1.0 in NPT retractable inline fitting. 0-100 μ S. |
| 1104592 | 540K.01-4-10I-10-TC500 | Condensate sensor with $\frac{3}{4}$ in NPT inline fitting. 0-10 μ S. |
| 1169642 | 540K.01-4-10R-18-TC500 | Condensate sensor with 1.0 NPT retractable inline fitting. 0-10 μ S. |

3.0 Unpacking, Mounting and Installation

3.1 Unpacking

Inspect the shipping carton for obvious external damage. Note on the carrier's bill-of-lading the extent of the damage, if any, and **notify the carrier**. Save the shipping carton until your Model 1575e controller is started up.

☎ If shipping damage has occurred, call the Lakewood Instruments Customer Service Department at (800) 228-0839 and return the controller to the factory in the original carton.

3.2 Mounting the Enclosure

The Model 1575e is supplied with four mounting holes in the enclosure and four mounting feet. The Model 1575e can be mounted to a panel or to a flat non-vibrating wall. There are two methods for mounting the enclosure to a wall or a panel.

The first method is to insert the mounting feet into the hole at each corner of the enclosure and use screws to attach the feet to the panel or wall.

The second method is to remove the front of the enclosure from the controller and insert screws through the holes at each corner of the enclosure.

The dimensions of the enclosure in inches are:

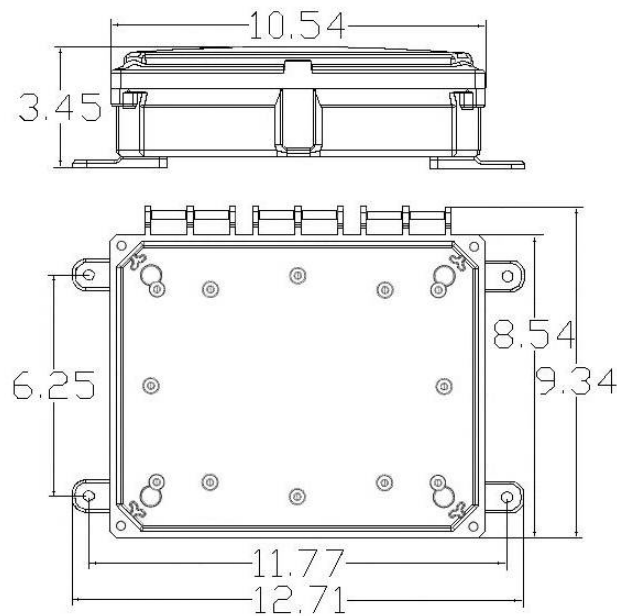

The model 1575e has a shipping weight of less than 5 lbs.

3.3 Plumbing Installation

3.3.1 Cooling Tower Plumbing

PLUMBING MATERIALS

- Inlet plumbing can be ¾ inch (1.9 cm) PVC, CPVC, or iron pipe.
- Provide at least 1 gpm (3.79 Lpm) to the sensor. A 4-psi (0.3 bar) differential pressure from take-off to injection is sufficient. If flow is marginal, consult your Lakewood Instruments Factory Representative. The maximum recommended flow is 5 gpm (18.93Lpm).
- Outlet plumbing can be ¾ inch (1.9 cm) PVC, CPVC, or iron pipe. PVC, CPVC Schedule 80 is recommended for strength and sunlight protection.
- If iron pipe is used, install a PVC union to relieve the stress on the plumbing.
- The sample line inlet should be plumbed downstream of the recirculating pump and upstream of the heat exchanger. This line brings the sample water into the sensor plumbing for conductivity measurement. If the Lakewood Instruments flow switch plumbing assembly is used, this flow of water also pushes the flow switch float up to activate the relay outputs of the controller.

NOTE: FOR YOUR CONVENIENCE, INCLUDE A LAKEWOOD INSTRUMENTS MODEL 9102 SAMPLE LINE SHUT-OFF VALVE AND A SAMPLE VALVE SPOUT (AS SHOWN) IN THE INLET FLOW PLUMBING.

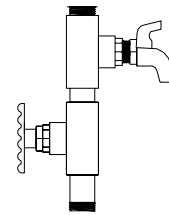

Figure 3:

Model 9102 Valve & Spout

- The sample line outlet flow (solution/sample line) should be plumbed to the tower return line or the tower basin, where you can insert your chemical feed system. Refer to the suggested installation drawing in the back of this manual for an example of a typical installation.
- Remember to install isolation and bypass valves so that maintenance can be performed.

WARNING: NEVER INJECT CHEMICALS UPSTREAM OF THE CONTROLLER FLOW CELLS!



If you have questions or need assistance, call Lakewood Instruments Technical Service Department at (800) 228-0839, Monday-Friday, 7:30 a.m. - 5:00 p.m. CST.

WARNING: SOME CHEMICALS MAY HAVE TO BE INJECTED DIRECTLY INTO THE COOLING SYSTEM WATER LINE AND NOT INTO THE SAMPLE LINE. CONTACT YOUR WATER TREATMENT SPECIALIST FOR SPECIFIC RECOMMENDATIONS.

NOTE: IF THE SOLUTION/SAMPLE LINE IS RETURNED TO THE COOLING TOWER RETURN LINE, USE A CORPORATION STOP (LAKEWOOD INSTRUMENTS MODEL 9160), A SOLUTION LINE INJECTOR OR A DISPERSING PIPE . THIS AIDS CHEMICAL-WATER MIXING AND ENHANCES WATER TREATMENT CONTROL CAPABILITIES.

3.3.1.1 Blowdown Valve Sizing

If you have a way to measure your blowdown flow rate and pressure range, you can use the chart below to determine the correct valve size. If not, consult your water treatment engineer.

Adjustable flow rate diaphragm valves require at least 10-psi (0.7 bar) differential pressure to close. If your water pressure is marginal, use a supply water pressure actuated diaphragm valve or a valve designed to work with zero differential pressure.

Extremely dirty cooling water will plug diaphragm valves. In such cases, use a motorized ball valve and a globe valve for flow control. A strainer ahead of the valve may be okay, but you must flush it regularly. If your flow lines are above 3 inch (for large systems), use a pneumatically operated butterfly valve.

Be sure to provide isolation and bypass valves. Refer to drawings in the back of the manual for examples of typical installations. If your blowdown valve ever fails, you need to be able to bypass it in order to service it.

| BLOWDOWN VALVE SIZING CHART | | | | | |
|------------------------------------|--------------|-------------------|--------------|-----------------------------|-------------|
| Pressure range | | Flow range | | Suggested Valve Size | |
| (psi) | (bar) | (gpm) | (Lpm) | (inch) | (cm) |
| 10-50 | 0.7-3.4 | 1-5 | 3.8-18.9 | ¾ inch | 1.9 cm |
| 50-150 | 3.4-10.3 | 5-10 | 18.9-37.9 | ¾ inch | 1.9 cm |
| 10-50 | 0.7-3.4 | 5-10 | 18.9-37.9 | 1 inch | 2.5 cm |
| 50-150 | 3.4-10.3 | 10-15 | 37.9-56.8 | 1 inch | 2.5 cm |
| 10-50 | 0.7-3.4 | 10-15 | 37.9-56.8 | 1½ inch | 3.8 cm |
| 50-150 | 3.4-10.3 | 15-20 | 56.8-75.7 | 1½ inch | 3.8 cm |
| 10-50 | 0.7-3.4 | 15-20 | 56.8-75.7 | 2 inch | 5.1 cm |
| 50-150 | 3.4-10.3 | 20-30 | 75.7-113.6 | 2 inch | 5.1 cm |
| 10-50 | 0.7-3.4 | 30-100 | 113.6-378.5 | 3 inch | 7.6 cm |
| 10-50 | 0.7-3.4 | 100-300 | 378.5-1135.5 | 4 inch | 10.2 cm |

3.3.2 Boiler Plumbing

PLUMBING INSTALLATION

There are two methods of automatic control of the conductivity in a boiler; sample/cycle and continuous sample. To decide if you should use continuous sample or sample/cycle control, determine your blowdown rate requirement. If your boiler requires greater than 1000 pounds per hour of blowdown to maintain conductivity then the continuous sample method should be used. If your blowdown requirement is less than 1000 pounds per hour, the sample/cycle method is appropriate.

The model 1575e can be used for either sample/cycle control or continuous sample control of the conductivity in the boiler. The installation drawing in the back of this manual shows how to plumb the boiler sample line so that it can be used as sample/cycle or continuous sample.

To prevent steam flashing and damage to the controller refer to the installation drawing in the back of the manual and notes below.

- Use piping from the boiler skimmer line as the sample and blowdown line.

NOTE: DO NOT USE THE BOTTOM BLOWDOWN OUTLET AS THE SAMPLE OR AUTOMATIC BLOWDOWN LINE.

- The maximum allowed wire distance between the controller and the sensor is 20 ft unless the 4-20 mA input is used.
- If using conduit between the sensor and controller, allow a place for water to escape if the sensor leaks. This will help prevent water damage to the controller.
- Use orifice plates or globe valves to prevent steam flash. The orifice plates or the globe valve should be mounted within 5 feet of the sensor. Orifice plates (or globe valve) and the sensor must be installed horizontally (as shown in the drawing).
- The sensor should be located at least two feet **below** the water level in the boiler.
- Ensure that there are no restrictions between the skimmer line and the orifice plates (or globe valve) and all valves upstream of the boiler sensor are fully open.
- Be sure to provide isolation valves in the sample line to allow for maintenance of the sensor.
- Refer to section 3.3.2.1 for the orifice sizing chart

NOTE: DO NOT RUN THE SENSOR WIRING IN THE SAME CONDUIT AS THE MOTORIZED VALVE WIRING.

3.3.2.1 Orifice Sizing Chart

Refer to the chart below to determine the orifice size that is required for a specific flow rate.

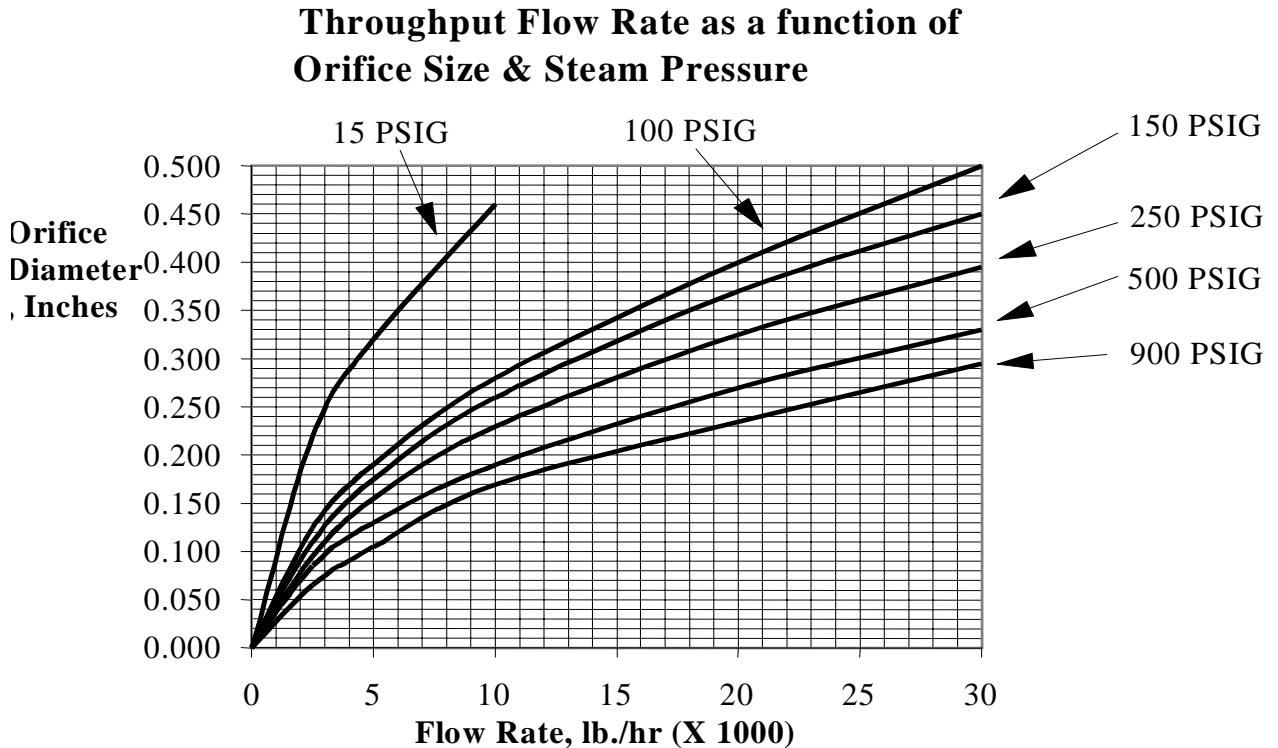

3.3.3 Condensate Plumbing

Lakewood Instruments recommends that the conductivity sensor be mounted per the drawing in the back of this manual. The sensor is mounted vertically to remove any air bubbles, which may otherwise collect around the sensor tip. Avoid connections in “dead leg” sections of pipe. An air pocket around the electrode tips will cause erroneous readings. The sensor electrodes should be in direct contact with the process flow.

3.3.4 Sensor Mounting

The conductivity sensor should be mounted in the horizontal position (except for the condensate sensor). When using the plumbing with the Flow Switch, be sure that the dome is in the upright position. Avoid connections in “dead leg” sections of pipe. An air pocket around the electrode tips will cause erroneous readings. The sensor electrodes should be in direct contact with the process flow. The water flow should be in the upward direction for cooling tower sensor and the condensate sensor. The flow should be in the downward direction for the boiler sensor.

3.4 Electrical Installation

3.4.1 Incoming Power 115/230 VAC

The Model 1575e can be powered from either 115 VAC or 230 VAC at 50/60 Hz. There is a power selector switch located in the upper left-hand corner of the control board. To select the appropriate voltage, simply slide the switch from one position to the other with a small screwdriver.

The Model 1575e controller comes with a power cord and female molded receptacles for the blowdown valve and chemical pumps. The power cord and receptacles are rated for 115VAC. If the controller will be powered by 230 VAC, the power cord and receptacles will need to be removed and the incoming power and the relay outputs will need to be hard-wired.

The incoming power is connected to terminal block P1 at the bottom left corner of the control board. There is a hot or line input (L1), a neutral input (N) and an earth ground input (⊕). Refer to the drawing in the back of this manual for wiring instructions.

3.4.2 Relay Outputs

The relay outputs are of the same voltage as the power input. Ensure that the devices that are to be connected to the relay outputs are of the same voltage rating or damage will occur.

The relay outputs are wired to the female molded receptacles. The molded receptacle on the far left is relay #1 and the molded receptacle on the far right is relay #4. If 115 VAC is used simply plug your devices into the molded receptacles. If 230 VAC is used, remove the receptacles and hard-wire your devices to the relay outputs.

Relay #1 has both a normally open and normally closed contact. This is designed for used with a motorized blowdown valve. The normally open (NO) contact is connected to the open connection of the valve and the normally closed (NC) contact is connected to the close connection of the valve. The other three relays only have a normally open contact. Each relay output has a neutral (N) connection and an earth ground connection (⊕) connection.



To operate the terminal blocks to remove or add wiring, insert a small screwdriver into the slot above each wiring connection and pry upward while removing or inserting the wire.

Refer to the drawing in the back of this manual for wiring instructions.

3.4.3 Flow Switch Wiring

The model 1575e has a flow switch input. The purpose of the flow switch input is to disable the relay outputs on a loss of flow in the system. The flow switch input requires a digital contact. Any digital contact rated for 24 VDC and 500 mA may be used, such as a relay driven by the recirculating pump. Lakewood Instruments manufactures a flow switch plumbing assembly for use with the model 1575e.

If a flow switch is not used then a jumper must be installed across the flow switch connections. Refer to the drawings in the back of this manual for wiring instructions.

3.4.4 Sensor Wiring

The model 1575e uses the Lakewood Instruments two electrode conductivity sensors. These sensors can be wired directly or a 4-20 mA device can amplify them. The maximum recommended wiring distance for sensors without a 4-20 mA device to amplify them is 20 feet.

Direct wired sensors are wired directly to the P8 terminal block on the upper right corner of the control board. Refer to the drawing in the back of this manual for wiring instructions for each of the available Lakewood Instruments conductivity sensors.

Sensors that are amplified by a 4-20 mA device are wired to terminal block P2. The model 1575e controller powers this 4-20 mA device. Refer to the drawing in the back of this manual for wiring instructions for the 4-20 mA input.

3.4.5 Water Meters

The Model 1575e will accept two water meter inputs. These inputs can be configured for make-up, make-up Second Source, Bleed, or Chill Loop make-up. Refer to the water meter manufacturer's manual for plumbing information.

The 1575e series controllers will work directly with the following types of meters: dry contacting head meters, Seametrics open collector output meters, Signet 2535 and 2540 paddle wheel meters, and the Autotrol 1 inch and 2 inch meters. Contact Lakewood Instruments for other types of water meters. The water meters are wired to terminal block P7 on the right-hand side of the control board. Refer to the drawing in the back of this manual for wiring instructions.

3.4.6 Drum Switch Inputs

The model 1575e will accept two drum switch inputs. The drum switches are wired to terminal block P5. The drum switch input requires a digital contact. Any digital contact rated for 24 VDC and 500 mA may be used. Refer to the drawing in the back of this manual for wiring instructions.

3.4.7 4-20 mA Output Wiring

The model 1575e has one 4-20 mA output for conductivity. This output can be isolated or non-isolated, externally powered or internally powered. If the 4-20 mA output is internally powered then it is non-isolated. If the 4-20 mA output is externally powered then it is isolated.

The 4-20 mA output is wired to terminal block P2 on the right-hand side of the control board. Refer to the drawing in the back of this manual for wiring instructions.

3.4.8 4-20 mA Input Wiring

The model 1575e can accept a 4-20 mA input as the primary conductivity input or as a secondary input for such things as makeup conductivity, pH, ORP, Trace Chemistry in ppm or ppb, percent, psi, milliamps, or flow rates in GPM or LPM. A sensor is wired to a 4-20mA transmitter and the transmitter is wired to terminals 4 (PWR) and 5 (IN) of terminal block P2 on the right-hand side of the control board. This input is a non-isolated input and the controller powers it. Refer to the manufacturer instructions for wiring of the 4-20mA transmitter.

Refer to the drawing in the back of this manual for wiring instructions.

4.0 Functional Overview

4.1 Front Panel

Figure 4: Model 1575e Front Panel with Display

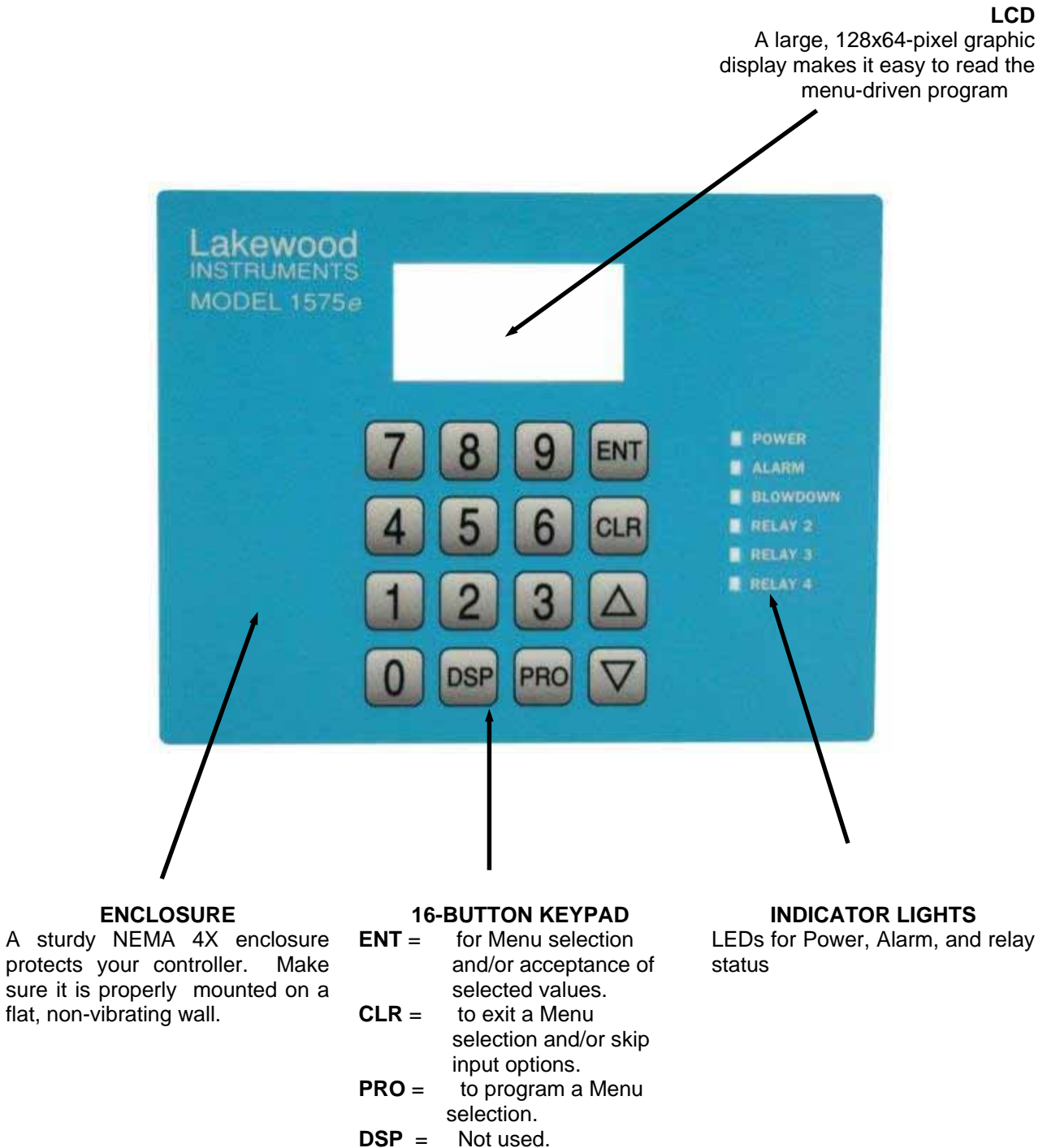

4.2 Display

The model 1575e uses an illuminated 128x64-pixel LCD digital display for ease of viewing. It has multiple lines to display information such as the conductivity reading, secondary input reading, alarms, relay status, relay configuration, clock, flow rates and total flow for both water meters, and menu selections.

4.3 Keypad

The model 1575e uses a 16-key steel-domed numeric keypad for ease of programming. The keys have the following functions:

| | |
|-------------|--|
| ENT | To accept a setting or to enter a screen. |
| CLR | To exit a screen or to access the main menu. |
| PRO | To calibrate the controller. |
| DSP | Not used. |
| UP arrow | To move about in the menu. |
| DOWN arrow | To move about in a menu. |
| Number keys | To input a value or to select a menu item. |

4.4 Menu

The model 1575e is programmed and calibrated by the use of a menu. The complete **Main Menu** has 8 available options that can be accessed in the **Technician Level**. However, a list of only six options can be viewed at one time. Use the **↑** and **↓** keys to scroll through the options. As an introduction, here is a graphic overview of the first level of each option in the **Main Menu** to see how it operates. Complete details of each option are provided later in this manual.

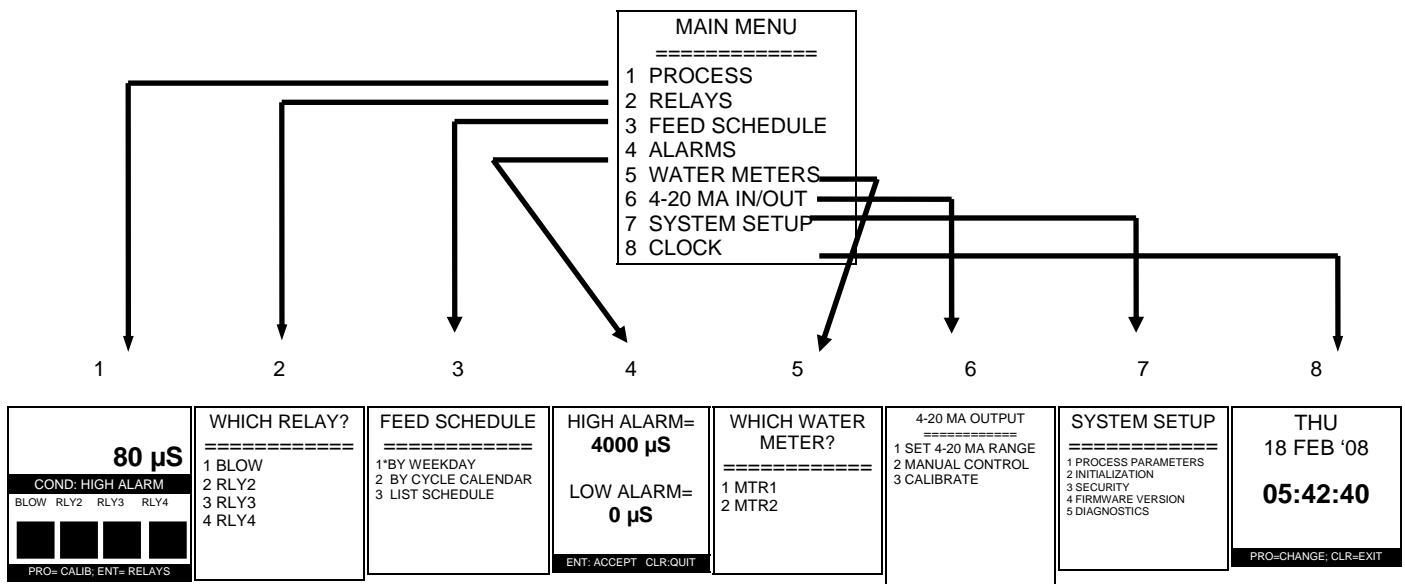

4.5 Security Levels

The model 1575e has a security level to prevent tampering of the controller. This security level is called View Only. When the controller is in the View Only security level, the menu is locked out. There are two things that can be done while in View Only; the relays can be operated manually and all of the process screens can be viewed.

There is a password associated with the view only security level. The default password is 2222. If the controller is in the view only mode just press 2222 on the keypad. This password can be changed in the main menu.

5.0 Starting Up the Controller

Once the Installation is complete it is time to start up the controller.

Initiate sample flow to the controller by opening the sample line isolation valves. Check for leakage.

Power up the controller by either turning on the circuit breaker or plugging the power cord into a 120 VAC receptacle.

It is best to initialize the whole controller to remove any settings that may be in the memory before programming the controller. Refer to section 6.5.7.2 of this manual to initialize the controller.

If conductivity will not be used with this controller, disable the conductivity input. Refer to section 6.5.7.1.4 of this manual.

If the 4-20mA input will be used enable the 4-20 mA input by following section 6.5.6.2.

If conductivity is used and it is not coming from a 4-20 mA device set up the cell constant and temperature compensation for the sensor. Follow sections 6.5.7.1.1 and section 6.1.7.1.2 respectively.

If this controller will be used in a boiler application, enable the anti-flashing in section 6.5.7.1.3.

Set the clock by following section 6.5.8.

Set the high and low alarms by following section 6.5.4.

Configure the relays for operation by following section 6.5.

Calibrate the readings by following section 6.3

Verify operation of the controller before leaving the area.

6.0 Operation of the Controller

6.1 Process Screen

The screen that is used the most in the 1575e controller is the Process Screen. Below are the process screen views. The process screen has three sections. The top section shows the conductivity reading. The alarm bar is the middle section and appears between the top and bottom sections. It is solid in appearance and flashes showing the current active alarms in sequence if there are multiple alarms. The bottom section has user selectable readings as shown below.

1 - DATE SCREEN

| |
|----------------------------|
| 0 μs |
| ALARM BAR |
| 3 MAR '98 |
| 11:55:04 |
| PRO=CALIB; ENT=RELAYS |

- There are many different screens available in the **PROCESS** screen. These screens allow you to view the units settings (incl. secondary input reading,time setting, relay set-ups, flow rates, total flow, etc.) without the danger of altering them. Access these screens by using the \uparrow and \downarrow keys to scroll through the available screens.
- Press "**ENT**" to manually enable a relay for testing or troubleshooting purposes.
- Press "**PRO**" to calibrate the conductivity and inputs.

2 - ALL RELAY SCREEN

| |
|--|
| 0 μs |
| NO FLOW |
| BLOW RLY2 RLY3 RLY4 |
| <input checked="" type="checkbox"/> <input type="checkbox"/> <input type="checkbox"/> <input type="checkbox"/> |
| PRO=CALIB; ENT=RELAYS |

5 - RELAY 2,3,4 SETTINGS

| |
|----------------------------|
| 0 μs |
| HIGH CONDUCTIVITY |
| RLY4: |
| DISABLED |
| <input type="checkbox"/> |
| PRO=CALIB; ENT=RELAYS |

8 - MTR1 FLOW RATE

| |
|----------------------------|
| 0 μs |
| LOW CONDUCTIVITY |
| MTR1 FLOW RATE= |
| 0 |
| PRO=CALIB; ENT=RELAYS |

3 - BLOW SETPOINT SCREEN

| |
|-------------------------------|
| 0 μs |
| OPENED TC |
| BLOW:SETPOINT= |
| 2500 μs |
| PRO=CALIB; ENT=RELAYS |

6 - MTR1 TOTAL FLOW

| |
|----------------------------|
| 0 μs |
| DRUM LEVEL #2 |
| MTR1 TOTAL FLOW= |
| 0 |
| PRO=CALIB; ENT=RELAYS |

9 - SECONDARY INPUT

| |
|----------------------------|
| 0 μs |
| RELAY #3 TIMEOUT |
| 0ppm |
| PRO=CALIB; ENT=RELAYS |

4 - RELAY 2 SETTINGS

| |
|----------------------------|
| 0 μs |
| BLOWDOWN TIMEOUT |
| RLY2: BY MTR2 METER |
| FEED AFTER GAL/S/LTRS= |
| 0 FOR 00:00 MM:SS |
| PRO=CALIB; ENT=RELAYS |

7 - MTR2 TOTAL FLOW

| |
|----------------------------|
| 0 μs |
| SHORTED TC |
| MTR2 TOTAL FLOW= |
| 0 |
| PRO=CALIB; ENT=RELAYS |

When conductivity is disabled the top half of the screen will look like this.

| |
|--|
| BLOW RLY2 RLY3 RLY4 |
| <input checked="" type="checkbox"/> <input type="checkbox"/> <input type="checkbox"/> <input type="checkbox"/> |

6.2 Manual Operation of the Relays

All four of the relays can be operated manually. To manually operate the relays:

Go to the **Process** screen. Press “**ENT**”. You will be taken to a screen that looks like:

| AUTO-MANUAL (5 MINS.) | |
|-----------------------|-------------------------------------|
| (1) BLOW | <input checked="" type="checkbox"/> |
| (2) RLY2 | <input type="checkbox"/> |
| (3) RLY3 | <input type="checkbox"/> |
| (4) RLY4 | <input type="checkbox"/> |
| Press 1-4; CLR=EXIT | |

Press “1-4 “ to manually change the state of that particular relay. If the relay is already on, pressing that number will turn it off. A five-minute countdown timer will start. After five minutes has expired the relay will return to automatic control. A relay that is in manual control will stay in manual control until the five minutes expires even if this screen is exited. The five-minute timer helps to prevent damage to the system if a relay is left in manual. **WARNING: Manual control overrides everything including the flow switch input. Use care when operating relays manually with no flow in the system.**

6.3 Calibration of Conductivity and the Secondary Input

The input readings require periodic calibration. Calibration is usually required for initial operation and after cleaning the sensor. The calibration that is performed is a single point calibration.

6.3.1 Calibration of On-Board Conductivity

Calibration should always be performed with the sensor in the piping assembly with good flow past the sensor. It is necessary to have an accurate reading of the blowdown water to properly calibrate the controller. A hand-held conductivity meter that tests the sample works well for this purpose. If a meter that measures ppm is used, refer to the conductivity vs. ppm chart in section 6.3.3 and convert the ppm to an approximate conductivity value.

If the conductivity sensor is connected to a 4-20 mA device, follow the manufacturer instructions for calibrating the 4-20mA output for that device.

If the conductivity sensor is directly wired to the 1575e controller follow these instructions for calibration.

For cooling towers, condensate and continuous sample boilers

- Ensure that the controller is operating with good flow past the sensor.
- Take a sample of the water and measure with a hand-held conductivity tester.
- From the **PROCESS** screen, press “**PRO**” to enter the calibration screen. If the Secondary 4-20mA Input is enabled the following screen will appear:

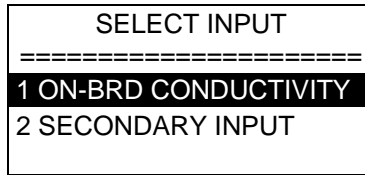

- Press “1” or highlight “**ON-BRD CONDUCTIVITY**” and press “**ENT**” to calibrate the conductivity input. NOTE: This screen does not appear if the 4-20mA input is disabled.

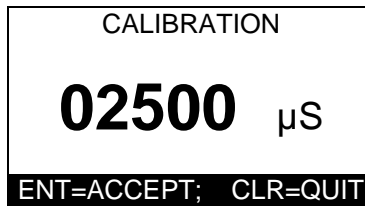

- Use the keypad to input the reading from the hand-held. Press “**ENT**”.
- Take another hand-held sample to verify calibration.

For sample/cycle boilers

- Manually energize the blowdown relay. Allow the water to flow past the sensor for a minimum of 60 seconds.
- Take a sample of the water and measure with a hand-held conductivity tester.
- From the **PROCESS** screen, press “**PRO**” to enter the calibration screen. If the Secondary 4-20mA Input is enabled the following screen will appear:

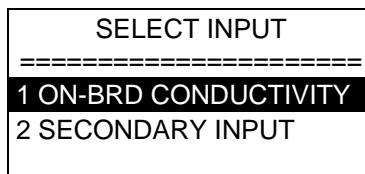

- Press “1” or highlight “**ON-BRD CONDUCTIVITY**” and press “**ENT**” to calibrate the conductivity input. NOTE: This screen does not appear if the 4-20mA input is disabled.

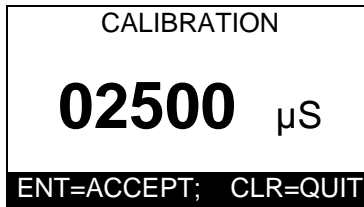

- Use the keypad to input the conductivity reading from the hand-held. Press “**ENT**”.
- Take another hand-held sample to verify calibration.
- Restore the blowdown relay to automatic control.

6.3.2 Calibration of Secondary 4-20mA Input Reading

Since the Secondary Input reading comes from a 4-20mA device, that device should be calibrated using the manufacturer instructions before calibrating the controller to that device. Also, the controller’s 4-20mA input should be calibrated as specified in section 6.5.6.2.3 before performing a single-point calibration using this procedure.

To calibrate the Secondary 4-20mA Input reading:

- Ensure that the controller is operating with good flow past the sensor.
- Take a sample of the water and measure with a hand-held tester.
- From the **PROCESS** screen, press “**PRO**” to enter the calibration screen. The following screen will appear:

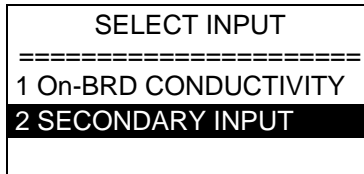

- Press “**2**” or highlight “**SECONDARY INPUT**” and press “**ENT**”. NOTE: This screen does not appear if the 4-20mA input is disabled.

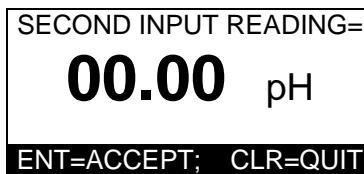

- Use the keypad to input the reading from the hand-held. Press “**ENT**”.
- Take another hand-held sample to verify calibration.

NOTE: If the secondary input is selected to measure in ppm or ppb, the following screen will appear:

| |
|---|
| <p>WARNING:</p> <p>TRACE SENSOR CALIBRATION REQUIRES PRIMARY SENSOR IN SAME SAMPLE FOR 10 MINUTES</p> <p>PRESS ANY KEY</p> |
|---|

- Place both the conductivity and the trace chemistry sensor in the same sample for at least 10 minutes to ensure a good calibration of the trace chemistry reading.

6.3.3 Conductivity vs. ppm

The model 1575e measures the conductivity of the water. The TDS of the water may be measured instead of conductivity. If TDS is measured, use the following chart for an approximation of the conductivity level and calibrate to the conductivity level that is closest to the ppm level that is measured. Remember this is just an approximation because the ions that make up the conductivity may be different than the particles that make up the ppm reading.

Conductivity vs. PPM Table

| $\mu\text{S/cm}$ | ppm | $\mu\text{S/cm}$ | ppm | $\mu\text{S/cm}$ | ppm |
|------------------|------|------------------|-----|------------------|------|
| 2 | 1 | 120 | 68 | 900 | 560 |
| 4 | 2.1 | 140 | 80 | 950 | 600 |
| 6 | 3.2 | 160 | 91 | 1000 | 630 |
| 8 | 4.2 | 180 | 100 | 1500 | 970 |
| 10 | 5.2 | 200 | 115 | 2000 | 1300 |
| 12 | 6.4 | 220 | 127 | 2500 | 1700 |
| 14 | 7.4 | 240 | 139 | 3000 | 2000 |
| 16 | 8.5 | 260 | 150 | 3400 | 2400 |
| 18 | 9.6 | 280 | 164 | 4000 | 2750 |
| 20 | 11.0 | 300 | 176 | 4500 | 3150 |
| 25 | 13.5 | 350 | 210 | 5000 | 3500 |
| 30 | 16.0 | 400 | 240 | 5500 | 3900 |
| 35 | 19.0 | 450 | 270 | 6000 | 4300 |
| 40 | 22.0 | 500 | 300 | 6500 | 4700 |
| 45 | 24.5 | 550 | 335 | 7000 | 5000 |
| 50 | 27.5 | 600 | 370 | 7500 | 5400 |
| 60 | 33.0 | 650 | 400 | 8000 | 5800 |
| 70 | 39.0 | 700 | 435 | 8500 | 6200 |
| 80 | 45.0 | 750 | 470 | 9000 | 6600 |
| 90 | 51.0 | 800 | 500 | 9500 | 7000 |
| 100 | 56.0 | 850 | 530 | 10,000 | 7400 |

6.4 Main Menu

The **MAIN MENU** of the 1575e looks like this:

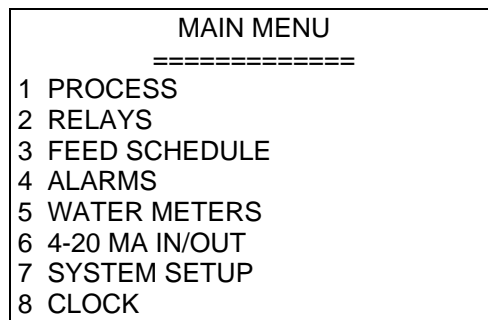

The **MAIN MENU** can be accessed from the **PROCESS** screen by pressing “**CLR**”. If “**CLR**” is pressed and the **MAIN MENU** does not appear, the controller is probably in the **VIEW ONLY** security mode. If the controller is in the **VIEW ONLY** security mode, enter the **TECHNICIAN** security password to be able to access the **MAIN MENU**.

To move about in the menu screen use the **↑** and **↓** keys to highlight the desired option and press “**ENT**” or simply press the number key for the desired option.

Use the “**ENT**” key to accept a setting or to enter a screen. Use the “**CLR**” key to reject a setting or to exit a screen. From anywhere in the menu, pressing “**CLR**” will take you one step closer to the **MAIN MENU**.

Each of the **MAIN MENU** options are discussed in detail later in this manual.

6.5 Configuring the Relays

To access the relay configuration screen from the **MAIN MENU**, press “**2**” or highlight **RELAYS** and press “**ENT**”. The following screen will appear.

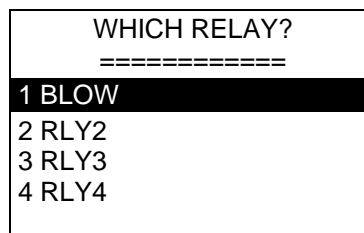

Select the relay that you want to configure.

6.5.1 Configuring the Blowdown Relay

The blowdown relay can be configured to operate based on a setpoint, cycles of concentration, or based on a water meter input. When the blowdown relay is selected for programming the following screen will appear.

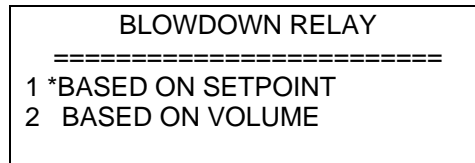

Blowdown can be configured based on a setpoint, cycles of concentration, or based on volume.

6.5.1.1 Based On Setpoint

To set up the blowdown relay to operate based on a setpoint or cycles of concentration, select based on setpoint. The following screen will appear.

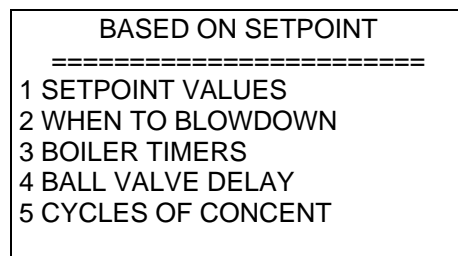

NOTE: Cycles of Concentration will only appear in this menu when the secondary 4-20mA input is enabled as conductivity.

6.5.1.1.1 SETPOINT VALUES

In the **SETPOINT VALUES** screen you will set the **SETPOINT**, the **DEADBAND** and the **EXCESS BLOWDOWN TIME** alarm.

The **SETPOINT** is the conductivity value that you are trying to maintain. Check with your water treatment engineer to determine the conductivity setpoint for your system needs.

Follow these instructions to establish the controller's setpoint:

- Press "1" or highlight **SETPOINT VALUES** and press "ENT".

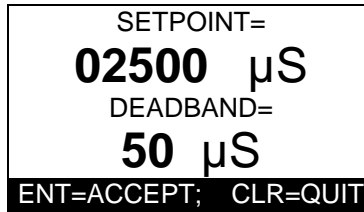

SETPOINT=
02500 μS
DEADBAND=
50 μS
ENT=ACCEPT; CLR=QUIT

- Use the keypad numbers to enter the proper conductivity setpoint and press "ENT". When finished, you will automatically be moved down to the deadband.

6.5.1.1.2 DEADBAND

After the setpoint is established, the controller's deadband must also be set. "**Deadband**" refers to the amount of conductivity above and below the setpoint—a range within which the controller will not react. Due to continuous fluctuations in the conductivity level, it is necessary to have this deadband range or stable readings will be difficult to obtain. The Deadband should be a small percentage of the setpoint. Half the deadband amount will be automatically put above the setpoint, and the other half below it.

For example, a conductivity setpoint of 1,000 μS with a deadband of 100 μS would result in the BLOWDOWN relay opening at 1,050 μS and closing at 950 μS .

- Use the keypad numbers to enter the proper deadband setpoint and press "ENT". When finished, you will automatically be switched to the **EXCESS BLOWDOWN TIME** alarm screen.

6.5.1.1.3 EXCESS BLOWDOWN TIME

The **EXCESS BLOWDOWN TIME** alarm is designed to notify the operator of a problem in the blowdown system such as, a clogged strainer or the blowdown valve did not open. The blowdown timeout function is strictly a visual alarm feature displayed on the 1575e series controller—it **will not close the blowdown valve**. If a relay is configured as an alarm relay, the **EXCESS BLOWDOWN TIME** alarm will energize the alarm relay. To disable this function, simply program 0 hours, 0 minutes.

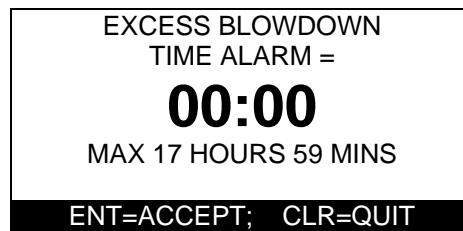

EXCESS BLOWDOWN
TIME ALARM =
00:00
MAX 17 HOURS 59 MINS
ENT=ACCEPT; CLR=QUIT

- Use the keypad numbers to enter the time in hours and minutes before this alarm will appear and press "ENT".

6.5.1.2 WHEN TO BLOWDOWN

Most applications for cooling towers and boilers will blowdown *above* the setpoint. There are some chill loop systems, however, where a reverse setpoint method is preferred. That is, blowdown occurs *below* the setpoint. In these applications the user will apply a chemical pump to the bleed outlet and feed a chemical to raise the conductivity of a chiller loop. If using this method be sure that the high conductivity alarm is set as high as possible.

- From the Based On Setpoint screen select **"2" WHEN TO BLOWDOWN**

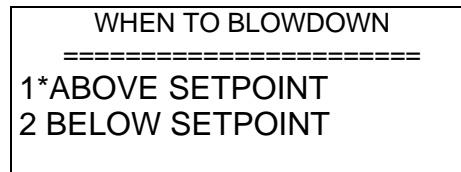

- In the **WHEN TO BLOWDOWN** screen, select **"1" ABOVE SETPOINT** to cause the blowdown relay to activate when the conductivity reading rises above the conductivity setpoint or **"2" BELOW SETPOINT** to cause the blowdown relay to activate when the conductivity reading falls below the conductivity setpoint.

6.5.1.3 BOILER TIMERS

For cooling tower, condensate and continuous sample boiler applications, these timers must remain at zero. In boiler applications where the sample/cycle method is used, times will be entered. A typical sample time is 2 minutes with a cycle time of 1 hour. A short sample time is desired to prevent excessive loss of water and heat. Once the sample time is set, it should never have to be changed again. The cycle time may need to be adjusted based on the steaming rate and make-up water quality.

If in the sample/cycle mode, the conductivity does not rise to the setpoint, the cycle time is probably set for too short of a time and will need to be adjusted to a longer period of time. If the conductivity is always above the setpoint, the cycle time is probably set at too long of a time and will need to be adjusted to a shorter period of time.

The sample time is set in minutes and seconds and the cycle time is set in hours and minutes. Lakewood Instruments recommends that you consult your water treatment professional for more information on using these settings.

To set the Sample and Cycle times:

- From the Based On Setpoint screen select “3” **BOILER TIMERS**

| | | |
|----------------------|----|----|
| SAMPLE TIME = | | |
| 00:00 | | |
| CYCLE TIME = | | |
| 00:00 | | |
| HH | MM | SS |
| ENT=ACCEPT; CLR=QUIT | | |

NOTE: For cooling tower, condensate and continuous sample boiler applications, these timers must remain at zero.

- Use the keypad numbers to enter the Sample Time in minutes and seconds and press “ENT”.
- Use the keypad numbers to enter the Cycle Time in hours and minutes and press “ENT”.

6.5.1.4 Ball Valve Delay

Motorized ball valves require a few seconds to open and close. If the valve is commanded to close before it completes the process of opening, it may enter a state where it is half-open. The ball valve delay feature prevents this from occurring. To use this feature, determine how many seconds it takes to open and close the valve. Use the longest time and round up 1 second. Use this value as your Ball valve delay time. This delay time will also be observed when manually operating the BLOWDOWN relay.

Recommended Delay Times

| Valve | Delay Time |
|--------------------|------------|
| Solenoid | 0 Seconds |
| Worcester Actuator | 8 Seconds |

6.5.1.5 Cycles of Concentration

The blowdown relay can be configured to operate based on cycles of concentration when the secondary 4-20mA input is configured as a conductivity input. When “**5**” **Cycles of Concent** is selected in the BASED ON SETPOINT menu, the following screen will appear:

USE CYCLES OF
CONCENTRATION INSTEAD
OF BLOWDOWN
SETPOINT?
=====

1 YES
2 NO

- Press “**1**” **Yes** to change the operation of the blowdown relay to Cycles of Concentration control or press “**2**” **NO** to return to the BASED of SETPOINT screen.

CYCLES OF CONCENT=
03.0
MIN = 1.0
MAX = 99.9

ENT=ACCEPT CLR=QUIT

- Use the keypad to enter the desired Cycles of Concentration setpoint and press “**ENT**” to accept or press “**CLR**” to return to the BASED on SETPOINT screen.

The next screen to appear is the Minimum Makeup Conductivity and Deadband screen. The minimum makeup conductivity is the lowest makeup conductivity that you expect to see during normal operation. This value will be used to calculate the cycles of concentration setpoint if the secondary 4-20mA input conductivity value drops below this setting. This is used to prevent the tower conductivity from being reduced below a desired minimum value. **NOTE:** If the secondary 4-20mA input conductivity value drops below this setting, this value will be displayed on the display Process screen instead of the actual secondary 4-20mA input conductivity value and the MIN MAKEUP CONDUCTIVITY alarm will be displayed.

MIN MAKEUP COND =
1000 μS
DEADBAND=
50 μS

ENT=ACCEPT CLR=QUIT

- Use the keypad to enter the minimum makeup conductivity value and press “**ENT**”.
- Use the keypad to enter a deadband value and press “**ENT**”. The controller will go to the EXCESS BLOWDOWN TIME ALARM screen.

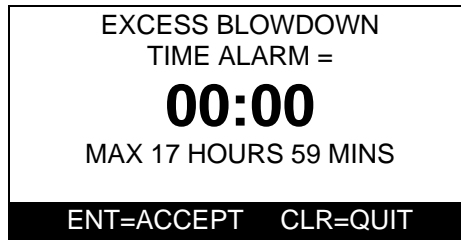

- Use the keypad numbers to enter the time in hours and minutes before this alarm will appear and press "ENT". NOTE: This alarm does not turn off the blowdown relay. To disable this function, set time alarm to 00:00.

6.5.1.6 Based on Volume

To program the blowdown to be based on volume, select "2" **BASED ON VOLUME** in the **BLOWDOWN RELAY** screen. The following screen will appear.

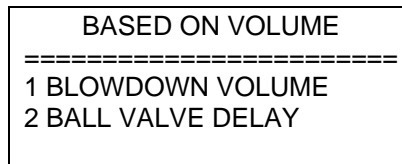

There are two methods available to blowdown based on volume, **TIME LIMITED** and **VOLUME LIMITED**.

With **TIME LIMITED**, the blowdown relay will be on for a specified amount of time after a specified amount of make-up has been received.

With **VOLUME LIMITED**, the blowdown relay will be on until a specified amount of blowdown is met.

After selecting **BLOWDOWN VOLUME**, another screen appears. This screen is the **HOW TO BLOWDOWN** screen. The two choices are: **1 TIME LIMITED** and **2 VOLUME LIMITED**.

If **TIME LIMITED** is selected:

- Select the water meter you want to base blowdown on by pressing "1" for **MTR1**, pressing "2" for **MTR2**, or pressing "3" for the sum of **BOTH** water meters.
- Use the keypad numbers to enter the proper water volume and press "ENT". You will automatically be moved down to the amount of time to blow down in minutes and seconds. Enter the amount of time to blowdown and press "ENT".

If **VOLUME LIMITED** is selected:

- The next screen that appears is **MAKEUP WATER METER?** Select the meter to which your makeup meter is wired and press **"ENT"**.
- Use the keypad to enter the volume of makeup after which you want to blowdown then press **"ENT"**
- Input the volume of blowdown that you want to blow down then press **"ENT"**.
- The next screen is the **EXCESS BLOWDOWN TIME ALARM** screen. Enter the amount of blowdown time before the **EXCESS BLOWDOWN TIME ALARM** will occur then press **"ENT"**. **This alarm will close the blowdown valve** and it will give an alarm indication on the display. The alarm time is set in hours and minutes. To disable this feature, enter **"00:00"**.

Ball Valve Delay

Refer to the section 6.5.1.4 for an explanation on the Ball Valve Delay feature.

6.5.2 Configuring Relays 2,3,4

Below is the **RELAY OPTIONS** screen for relays 2, 3, and 4. The asterisk (*) next to one of the options tells you how that relay is configured to feed. Relays 2, 3, and 4 can be programmed in each of the methods shown on the RELAY OPTIONS screen.

```

          RLY2
=====
1*DISABLED
2 SETPOINT
3 WATER METER
4 PERCENT BLOWDOWN
5 PERCENT OF TIME
6 FEED SCHEDULE
7 ALARM RELAY

```

6.5.2.1 Disabled

Relays 2, 3, and 4 can be disabled. When a relay is disabled, it will not energize.

- From the **RELAY OPTIONS** screen press **"1" Disabled** to disable the relay.

```

          DISABLED
          PRESS ANY KEY

```

6.5.2.2 By Setpoint

Relays 2, 3, and 4 can be configured to operate based on a conductivity setpoint, secondary input setpoint, or based on Trace Chemistry control setpoint. Refer to section 6.5.1.1.1 and 6.5.1.1.2 for a description of the setpoint and deadband.

When relays 2, 3, or 4 are configured for setpoint control, **the timeout alarm will shut off the relay when the timeout time expires.**

6.5.2.2.1 Setpoint Values – Select Input

- From the **RELAY OPTIONS** screen press **“2” SETPOINT** to configure the relay as a setpoint relay. If the Secondary Input is enabled, the following screen will appear:

| | |
|--------------|--------------|
| SELECT INPUT | |
| ===== | |
| 1* | CONDUCTIVITY |
| 2 | SECONDARY |

NOTE: The screen above will only appear if the secondary input has been enabled.

- Press **“1” CONDUCTIVITY** to set the relay to operate based on a conductivity setpoint or press **“2” SECONDARY** to set the relay to operate based on the secondary setpoint. If **SECONDARY** is selected the following screen will appear:

| | |
|---|-----|
| USE SECONDARY INPUT SETPOINT INSTEAD OF CONDUCTIVITY SETPOINT? | |
| ===== | |
| 1 | YES |
| 2 | NO |

- Press **“1” YES** to select the secondary input as the setpoint or **“2” NO** to return to the previous screen. If **“1” YES** is selected the following screen will appear if the secondary input is configured as either **ppm** or **ppb**.

| | |
|-------------------------------------|----------|
| SECONDARY INPUT MEASUREMENT TYPE | |
| ===== | |
| == | |
| 1* | STANDARD |
| 2 | TRACE |

- Press **“1” STANDARD** for standard setpoint control and press **“2” TRACE** for Trace Chemistry control. Refer to section 6.5.2.2.4 for more information on Trace Chemistry control setpoint.

6.5.2.2.2 Setpoint Values - Based on Setpoint

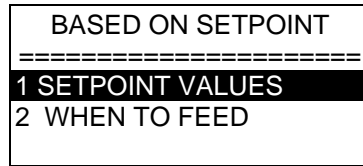

- Press "1" **SETPOINT VALUES** to enter the Setpoint Values screen.

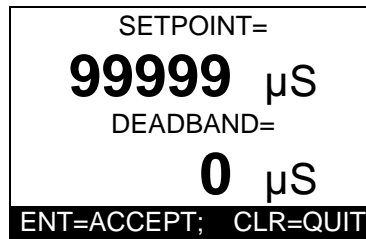

- Use the keypad to enter the **SETPOINT**, press "ENT". Enter the **DEADBAND** value, press "ENT". This will take you to the **TIMEOUT** screen.

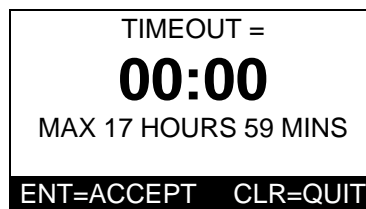

- Enter a time for the **TIMEOUT** alarm. The **TIMEOUT** alarm will turn off the relay. Enter "00:00" to disable this feature.

6.5.2.2.3 Setpoint Values - When to Feed

- From the **BASED ON SETPOINT** screen press "2" **WHEN TO FEED**.

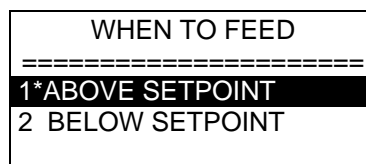

- **Select "1" ABOVE SETPOINT** to cause the relay to activate when the input reading rises above the setpoint or **"2" BELOW SETPOINT** to cause the relay to activate when the input reading falls below the setpoint.

6.5.2.2.4 Setpoint Values -Trace Chemistry Control

Trace Chemistry Control is available when the 4-20 mA input is configured as a secondary input and select to either ppm or ppb. The model 1575e will accept the 4-20 mA output from a fluorometer and use a correction factor to correct the reading for system induced errors. This corrected value is displayed and used to control relays. Relays 2, 3, and 4 can be used to control based on a trace setpoint.

To configure a relay for a trace setpoint, select the relay to activate as a trace setpoint:

- From the **RELAY OPTIONS** screen press “**2**” **SETPOINT** to configure the relay as a setpoint relay. The following screen will appear:

| |
|-----------------------|
| SELECT INPUT |
| ===== |
| 1*CONDUCTIVITY |
| 2 SECONDARY |

NOTE: The screen above will only appear if the secondary input has been enabled.

- Press “**2**” **SECONDARY** to set the relay to operate based on the secondary setpoint. The following screen will appear:

| |
|---|
| USE SECONDARY INPUT SETPOINT INSTEAD OF CONDUCTIVITY SETPOINT? |
| ===== |
| 1 YES |
| 2 NO |

- Press “**1**”**YES** to select the secondary input as the setpoint. The following screen will appear if the secondary input is configured as either **ppm** or **ppb**.

| |
|-------------------------------------|
| SECONDARY INPUT MEASUREMENT TYPE |
| ===== |
| 1*STANDARD |
| 2 TRACE |

- Press “**2**” **TRACE** for Trace Chemistry setpoint control.

| |
|-----------------------------|
| TRACE SETPOINT= |
| 999.9 ppb |
| TRACE DEADBAND= |
| 0.0 ppb |
| ENT=ACCEPT; CLR=QUIT |

- Use the keypad to enter the **TRACE SETPOINT**, press “**ENT**”. Enter the **TRACE DEADBAND** value, press ”**ENT**”. This will take you to the **TRACE TIMEOUT** screen. NOTE: The units (ppb or ppm) displayed are configured in the 4-20 mA setup section 6.5.6.2.1.

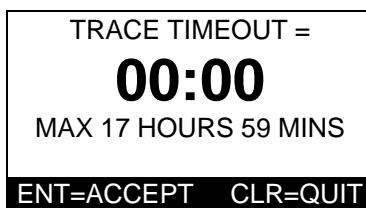

- Enter a time for the **TIMEOUT** alarm. The **TIMEOUT** alarm will turn off the relay. Enter ”**00:00**” to disable this feature. This will take you to the correction factor screen.

6.5.2.2.5 Setpoint Values -Trace Chemistry Control -Correction Factor

The Correction Factor is used to correct the Trace reading for system caused errors and is specific to the chemical that is fed. Contact Lakewood Instruments to help determine your correction factor. The normal correction for PTSA is 007.

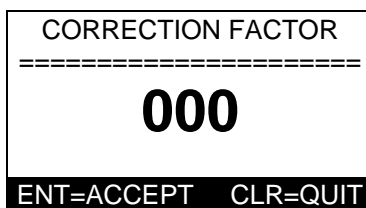

- Use the keypad to enter the **CORRECTION FACTOR** and press “**ENT**”. You will be taken to the FEED by % ON-TIME screen:

6.5.2.2.6 Setpoint Values -Trace Chemistry Control –Percent of Time

Since the trace reading does not immediately change when feeding a traced chemical, Lakewood has added a percent of on-time feature to the trace setpoint control scheme. It works just like the normal Percent On-Time setting but with a setpoint override.

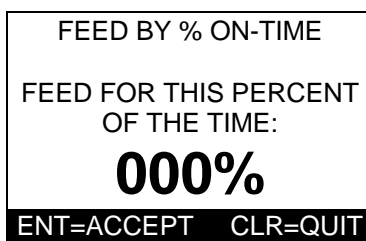

- Use the keypad to enter the **Percentage On-Time** and press “**ENT**”. You will be taken back to the BASED on SETPOINT screen to set the setpoint direction.

This relay control scheme works in patterns of 20-second time blocks. The relay will be off for some multiple of 20 seconds and then on for some multiple of 20 seconds depending on the percentage of time selected. The relay will repeat the 20 second time block sequence until the reading satisfies the setpoint. Below is a chart showing some of the operation times for Percent of Time.

| Percent | On Time | Off Time |
|---------|------------------------|------------------------|
| 1% | 20 Sec | 1980 Sec (33m) |
| 5% | 20 Sec | 380 Sec (6m20S) |
| 10% | 20 Sec | 180 Sec (3 m) |
| 25% | 20 Sec | 60 Sec |
| 33% | 20 Sec | 40 Sec |
| 50% | 20 Sec | 20 Sec |
| 66% | 40 Sec | 20 Sec |
| 75% | 60 Sec | 20 Sec |
| 90% | 180 Sec (3 m) | 20 Sec |
| 95% | 380 Sec (6m20S) | 20 Sec |
| 99% | 1980 Sec (33m) | 20 Sec |

Refer to section 6.5.2.5 for a further discussion of Percent of Time.

6.5.2.2.7 Setpoint Values -Trace Chemistry Control –When to Feed

Traced chemistry can be fed either Above the Setpoint or Below the Setpoint. Normally, it is fed Below the Setpoint.

| |
|--|
| BASED ON SETPOINT ===== 1 SETPOINT VALUES 2 WHEN TO FEED |
|--|

- From the **BASED ON SETPOINT** screen, press **"2" WHEN TO FEED**.

| |
|--|
| WHEN TO FEED ===== 1*ABOVE SETPOINT 2 BELOW SETPOINT |
|--|

- Select **"1" ABOVE SETPOINT** to cause the relay to activate when the input reading rises above the setpoint or **"2" BELOW SETPOINT** to cause the relay to activate when the input reading falls below the setpoint. **BELOW SETPOINT** is usually selected for Trace Chemistry control.

6.5.2.3 By Water Meter

Relays 2, 3, and 4 can be configured to operate for a specified amount of time based on a specified amount of flow through the water meter inputs. MTR1, MTR2 or the sum of BOTH water meter inputs can activate the relay.

- From the **RELAY OPTIONS** screen press **"3" WATER METER**.

| |
|-----------------------------|
| WHICH WATER METER? ===== |
| 1*MTR1 |
| 2 MTR2 |
| 3 BOTH |

- Select either **MTR1** or **MTR2** or **BOTH** as the trigger for the relay.

| |
|--|
| FEED BY WATER METER AFTER GALS/LTRS= 00000.0 MINS:SECS TO FEED= 00:00 ENT=ACCEPT CLR=QUIT |
|--|

- Use the keypad to enter the amount of flow before the relay is activated. Press **"ENT"**.
- Enter the amount of time that the relay will be activated. Press **"ENT"**.

6.5.2.4 By Percent of Blowdown Time

Relays 2, 3, and 4 can be activated by a percent of the time that the blowdown was on. The relay will activate after the blowdown shuts off. For example, if 50% is entered and the blowdown relay is on for 10 minutes, the relay will be energized for 5 minutes after the blowdown turns off.

- From the **RELAY OPTIONS** screen, press **"4" PERCENT BLOWDOWN**.

| |
|--|
| FEED BY BLOWDOWN AFTER BLOWDOWN GOES OFF. FEED FOR THIS PERCENT OF TIME THAT BLOWDOWN WAS ON: 00% ENT=ACCEPT CLR=QUIT |
|--|

- Use the keypad to enter a percent of blowdown time to activate this relay. Press **"ENT"**.

6.5.2.5 By Percent of Time

The Percent of Time feature allows you to feed chemical strictly based by a percent of time. This relay control scheme works in patterns of 20-second time blocks. A relay is on for some multiple of 20 seconds and off for some multiple of 20 seconds. Below is a chart showing some of the operation times for Percent of Time.

| Percent | On Time | Off Time |
|---------|------------------------|------------------------|
| 1% | 20 Sec | 1980 Sec (33m) |
| 5% | 20 Sec | 380 Sec (6m20S) |
| 10% | 20 Sec | 180 Sec (3 m) |
| 25% | 20 Sec | 60 Sec |
| 33% | 20 Sec | 40 Sec |
| 50% | 20 Sec | 20 Sec |
| 66% | 40 Sec | 20 Sec |
| 75% | 60 Sec | 20 Sec |
| 90% | 180 Sec (3 m) | 20 Sec |
| 95% | 380 Sec (6m20S) | 20 Sec |
| 99% | 1980 Sec (33m) | 20 Sec |

Note: In the case of “33%”, once every 66 minutes, the “off” time would extend an extra 20 seconds to make up for the accumulation of the odd % value vs. a 24 hour clock, since the percent of time is based on a 24HR clock in 20 second increments. The same could be said for the “66%” timer, except it will remain “ON” for the additional 20 seconds every 66 minutes.

To determine the total amount of chemical fed over a 24 hour period, multiply the percent of time by the number of hours a day that your controller is operating, then multiply by your chemical pump flow rate per hour.

For example:

We select 10% of the time, our controller operates 24 hours a day and our chemical pump flow rate is 1 gallon per hour.

$$10\% \times \frac{24 \text{ hours}}{\text{Day}} \times \frac{1 \text{ gallon}}{\text{Hour}} = \frac{2.4 \text{ Gallons}}{\text{Day}}$$

- From the **RELAY OPTIONS** screen press **”5” PERCENT OF TIME**.
- Use the keypad to enter the percentage of time desired. Press **”ENT”**.

6.5.2.6 By Feed Schedule

The feed schedule is used to feed chemicals such as biocides on a time of day basis. Setting up the feed schedule is a two-part process. The first part is to configure the relay so that it will operate by feed schedule. The second part of the process is to configure the feed schedule. The feed schedule is covered in section 6.5.3.

- From the **RELAY OPTIONS** screen press "6" **FEED SCHEDULE**.

The controller will respond with the following screen.

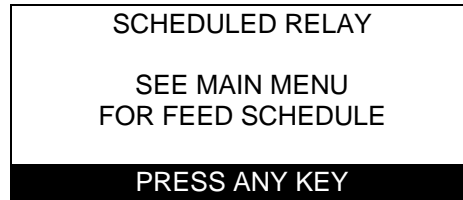

The relay has been configured to operate based on a feed schedule but, the relay will not activate because the feed schedule has not been programmed yet.

6.5.2.7 As an Alarm Relay

Relays 2, 3, and 4 can be configured as alarm relays. Any alarm will cause the relay to activate. These alarms include: HIGH CONDUCTIVITY, LOW CONDUCTIVITY, HIGH SECONDARY, LOW SECONDARY, MIN MAKEUP COND, OPENED TC, SHORTED TC, DRUM LEVEL #1, DRUM LEVEL #2, BLOWDOWN TIMEOUT, RELAY #2 TIMEOUT, RELAY #3 TIMEOUT, RELAY #4 TIMEOUT, and the NO FLOW alarm.

- From the **RELAY OPTIONS** screen press "7" **ALARM RELAY**. The controller will respond with the following screen.



NOTE: A relay that is configured as an alarm relay will be activated any time any alarm including the "NO FLOW" alarm is present.

6.5.3 Setting Up the Feed Schedule

Refer to section 6.5.2.6 to configure a relay to feed based on the feed schedule before continuing with this section.

To get to the feed schedule menu:

- From the **MAIN MENU** press "**3**" **FEED SCHEDULE**. You will see the following screen:

```
FEED SCHEDULE
=====
1*BY WEEKDAY
2 BY CYCLE CALENDAR
3 LIST SCHEDULE
```

The feed schedule can be programmed to feed chemicals by either **WEEKDAY** or by a **CYCLE CALENDAR** basis.

BY WEEKDAY is used to feed chemicals by the weekday name, i.e. Monday, Tuesday, Wednesday etc.. This is a seven-day schedule. At the end of the week, the schedule starts over again. To configure the feed schedule to feed by weekday:

- From the **FEED SCHEDULE** screen, press "**1**" **BY WEEKDAY**.

BY CYCLE CALENDAR is used to feed chemicals by a schedule other than one that is seven days long. **BY CYCLE CALENDAR** can be used to feed the same chemical every day or up to 28 days between feedings. The operator specifies the number of days in the cycle calendar. After the cycle calendar is completed, the schedule starts over again. This method of feeding is particularly useful when feeding two biocides on alternating weekly basis. To configure the feed schedule to feed by cycle calendar:

- From the **FEED SCHEDULE** screen, press "**2**" **BY CYCLE CALENDAR**.
- Use the keypad to enter the number of days in your cycle then press "**ENT**". Remember the maximum number of days allowed is 28.
- Use the keypad to enter which day today is in your cycle. E g. today is day number 5 in my 14 day cycle. Then press "**ENT**".

After selecting whether the feed schedule will be fed by **WEEKDAY** or by **CYCLE CALENDAR** it is time to actually program the schedule. To enter the actual feed schedule or to edit the feed schedule from the feed schedule screen above:

- Press "**3**" **LIST SCHEDULE**. This will take you to a list of all scheduled feeds as shown in the screen on the next page.

NOTE: The maximum number of scheduled feeds is 12 (twelve) total.
NOTE: ALL TIMES ARE IN HOURS AND MINUTES

| FEED SCHEDULE | | | |
|---------------|----|-------|------|
| ===== | | | |
| 1 | 01 | 03:00 | RLY2 |
| 2 | 00 | 00:00 | |
| 3 | 00 | 00:00 | |
| 4 | 00 | 00:00 | |
| 5 | 00 | 00:00 | |
| 6 | 00 | 00:00 | |

- If there are no scheduled feeds, select the first schedule and press "ENT". If you are editing the schedule, select the schedule that you want to edit and press "ENT".

Below is an example screen for programming a chemical feed. Before programming a chemical feed, you need to configure Relay 2, 3, or 4 to be a feed schedule relay.

| | |
|--|---------|
| RELAY (ARROWS): | NONE |
| CYCLE DAY | : 0 |
| START TIME | : 00:00 |
| COND SETPOINT | : 0 |
| BLOW DURATION | : 00:00 |
| FEED DURATION | : 00:00 |
| LOCKOUT TIME | : 00:00 |
| <UP><DOWN>ENT: ACCEPT | |

- To program the schedule use the keypad to enter the values in the above screen. Press "ENT" to move to the next item.

RELAY is which relay you want to program (you must configure a relay to be a feed schedule relay first). Use the arrow keys to select the available relays.

CYCLE DAY or DAY is the day you wish to actuate the feed schedule relay.

START TIME is the time you want to start the feed schedule sequence.

COND SETPOINT is a pre-bleed setpoint. This would typically be lower than the normal conductivity setpoint. Because the bleed valve will be disabled during a scheduled feed, a pre-bleed will help prevent a build up of tower conductivity. 0 µS will disable this feature. **This feature has no effect when conductivity is disabled.**

BLOW DURATION if the COND SETPOINT is not met within this time, the blowdown will stop and the feed schedule relay will be actuated. **If conductivity is disabled, this is the amount of time the controller will blow down during the pre-bleed sequence.** Inputting 0:00 will disable this feature. Lakewood Instruments recommends that some time be entered if pre-bleed is used.

FEED DURATION is the amount of time the feed schedule relay will be on.

LOCKOUT TIME after the feed schedule relay is done, an additional lockout time for the **BLOW, 2, 3, and 4** relays can be programmed. The lockout time prevents the other relays from operating until this time expires. Setting this time to 0:00 will disable this feature.

6.5.4 Alarms

The Model 1575e is equipped with both high and low conductivity alarms and secondary high and low alarms if the secondary 4-20mA input is enabled. This menu option allows you to program the specific values for these alarms. When a high or low alarm is received, it will appear as a flashing message in the middle of the display and any configured alarm relays will be activated. Consult your water treatment specialist when determining the proper High and Low Alarm values for your system.

To set the alarm settings:

- From the **MAIN MENU** press "4" **ALARMS**.

NOTE: If the secondary 4-20 mA input is enabled the following screen will appear:

```
SET ALARMS FOR
WHICH INPUT?
=====
1 ON-BRD CONDUCTIVITY
2 SECONDARY INPUT
```

- Press "1" **ON-BRD CONDUCTIVITY** to set the conductivity alarms or press "2" **SECONDARY INPUT** to set the secondary input alarms.

```
HIGH ALARM=
05000 µS

LOW ALARM=
100 µS

ENT: ACCEPT CLR:QUIT
```

- Use the keypad to enter a value for the high alarm and press "ENT".
- Use the keypad to enter a value for the low alarm and press "ENT".

NOTE: The on-board high conductivity alarm will override the normal conductivity setpoint and force a blowdown to occur.

6.5.5 Water Meters

The 1575e series controllers will work directly with the following types of meters: dry contacting head meters, Seametrics open collector output meters, Signet 2535 and 2540 paddle wheel meters, and the Autotrol 1 inch and 2 inch meters. Contact Lakewood Instruments for other types of water meters.

Both water meter inputs are programmed in the same manner.

To get to the water meter configuration screen:

- From the **main menu**, press **"5"** **WATER METERS**. This will take you to the **WHICH WATER METER SCREEN**.
- Press **"1"** for **MTR1** or press **"2"** for **MTR2**.
- The water meters can be configured for gallons or liters. Press **"1"** for **GALLONS** or press **"2"** for **LITERS**.
- This will take you to the **WATER METER TYPES** screen as shown below.

```
WATER METER TYPES
=====
1 CONTACTING HEAD
2 PADDLE WHEEL
3 AUTOTROL TURB 1 IN.
4 AUTOTROL TURB 2 IN.
```

- Use the keypad to select the type of water meter that you are using.

If **CONTACTING HEAD** is selected:

- You will be taken to the **GALLONS OR LITERS PER CONTACT** screen. Use the keypad to enter the number of gallons or liters per contact for your specific meter then press **"ENT"**. You will then be asked if you want to reset the total count for that meter to zero. Press **"1"** for **YES** or press **"2"** for **NO**.

If **PADDLE WHEEL** is selected:

- You will be taken to the **K-FACTOR** screen. Use the keypad to enter the K-factor for your particular water meter then press **"ENT"**. You will then be asked if you want to reset the total count for that meter to zero. Press **"1"** for **YES** or press **"2"** for **NO**.

If **AUTOTROL TURB 1 IN.** is selected:

- The controller will confirm that the **AUTOTROL TURB 1 IN.** has been selected and you will be asked if you want to reset the total count for that meter to zero. Press **"1"** for **YES** or press **"2"** for **NO**.

If the **AUTOTROL TURB 2 IN.** is selected:

- The controller will confirm that the **AUTOTROL TURB 2 IN.** has been selected and you will be asked if you want to reset the total count for that meter to zero. Press "1" for **YES** or press "2" for **NO**.

6.5.6 4-20 mA IN/OUT

The model 1575e has one 4-20 mA output that is configured for the conductivity.

The model 1575e has a 4-20 mA input that can be used as a remote conductivity input to the controller or as a secondary input to the controller.

6.5.6.1 Set Up of the 4-20 mA Output

To set up the 4-20 mA output:

- From the **Main Menu**, press "6" **4-20 mA IN/OUT**.
- Press "1" **4-20 mA OUT SETUP**.

The **4-20 mA Out Setup** screen allows the operator to; set the 4-20 mA range, take manual control of the 4-20 mA output and calibrate the 4-20 mA output. Below is the **4-20 mA Setup** screen.

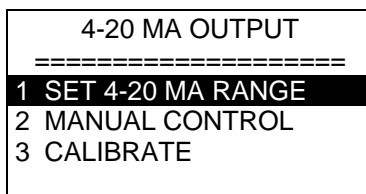

Set the 4-20 mA Output Range

The 4-20 mA output range must be set for the output to be useful.

- From the **4-20 mA Setup** screen, press "1" **Set the 4-20 mA RANGE**.

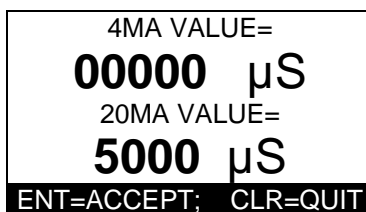

- Use the keypad to enter a conductivity value for the 4-mA point. Press "ENT".
- Use the keypad to enter a conductivity value for the 20-mA point. Press "ENT".

Manual 4-20 mA Output Control

Manual control is used to temporarily change the 4-20 mA output.

- From the **4-20 mA Setup** screen, press **"2"** **MANUAL CONTROL**.

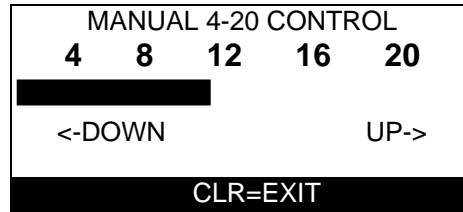

- Use the up and down arrow keys to raise or lower the 4-20 mA output. To exit this screen press **"CLR"**.

Calibrate the 4-20 mA Output

The 4-20 mA needs to be calibrated to the actual output to be accurate. A milliamp meter is necessary to calibrate the 4-20 mA output. Connect the milliamp meter in-line with one leg of the 4-20 mA output. Refer to the drawing in the back of this manual for wiring instructions.

- From the **4-20 mA Setup** screen, press **"3"** **CALIBRATE**.

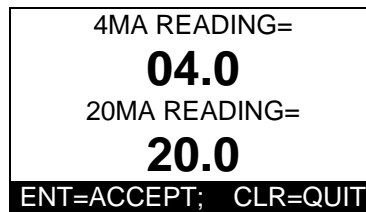

- Use the keypad to enter the milliamp reading from the milliamp meter for the **4-mA** point. Press **"ENT"**.
- Use the keypad to enter the milliamp reading from the milliamp meter for the **20-mA** point. Press **"ENT"**.

6.5.6.2 Set Up of the 4-20 mA Input

The 4-20 mA input can be used for a remote conductivity application where the conductivity sensor will be mounted greater than 20 feet from the controller. It can also be used as a secondary input for makeup conductivity, pH, ORP, percentage, pressure, milliamps, flow rates, or traced chemistry control. An external 4-20 mA device and an analog signal conditioner are required. Contact the factory for recommended analog signal conditioners.

NOTE: Certain parts of the menu are accessible only after the 4-20 mA input has been enabled.

To set up the 4-20 mA input:

- From the Main Menu press "6" **4-20 mA IN/OUT**.
- Press "2" **4-20 mA IN SETUP**.

There are three things items in the **4-20 mA IN Setup** screen; enable or disable the 4-20 mA input, set the 4-20 mA range, and calibrate the 4-20 mA input. Below is the **4-20 mA INPUT** setup screen.

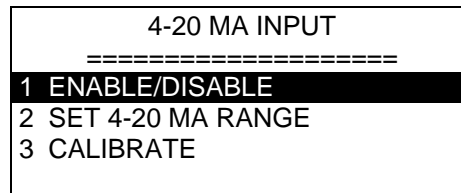

6.5.6.2.1 Enable/Disable the 4-20 mA Input

To use the 4-20 mA input, it must be enabled. It can be enabled as the primary conductivity input or as a secondary input. When enabled as the primary conductivity input, the on-board conductivity input will be disabled and the conductivity input will be supplied to the controller via a 4-20 mA signal. When used as a secondary input, it will act as a second input to the controller.

- From the **4-20 mA INPUT** setup screen, press "1" **ENABLE/DISABLE**.

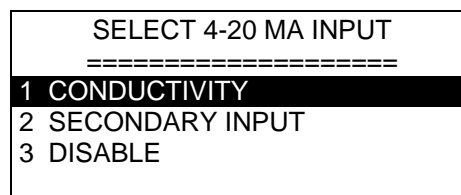

- Press "1" to enable the 4-20 mA input as the primary conductivity input in place of the on board conductivity input.
- Press "2" to enable the 4-20 mA input as a secondary input used along with the primary conductivity input.
- Press "3" to disable the 4-20 mA input.

When “1” **CONDUCTIVITY** is selected above, the controller will respond with the following screen:

```
4-20 MA CONDUCTIVITY
      ENABLED

ON-BOARD CONDUCTIVITY
      DISABLED

PRESS ANY KEY
```

When “2” **SECONDARY INPUT** is selected, you will be directed to select an input type and an input format for the 4-20 mA input:

```
SECONDARY INPUT TYPE
=====
1 *MICROSIEMENS
2 pH
3 MILLIVOLTS
4 PPM
5 PPB
6 PERCENT
7 PSI
8 MILLIAMPS
9 GPM
10 LPM
```

Use the arrow keys to highlight your desired selection and press “**ENT**” to select.

When “1” **MICROSIEMENS** is selected, the 4-20 mA input will act as a second conductivity input to the controller and may be used as MAKEUP CONDUCTIVITY. The BLOWDOWN relay will have an added feature to control by cycles of concentration. When “3” **PPM** or “4” **PPB** are selected, relays 2, 3, and 4 have an added feature for Trace Chemistry Control.

When any other selection is made, relays 2, 3, and 4 will have an added feature to control based on the secondary input setpoint.

Once the Secondary Input Type is selected, the controller will go to the **Secondary Input Format** screen. This screen allows the user to select the display format for the secondary input by changing the number of significant digits. It is recommended that the minimum number of significant digits be selected:

```
SECONDARY INPUT FORMAT
=====
999.9 μS

PRESS DSP TO CHANGE
ENT=SAVE      CLR =QUIT
```

Use the **DSP** key to change the number of significant digits and press “**ENT**” to save.

The controller will respond with the following screen:



Press any key to return to the 4-20 MA INPUT screen.

6.5.6.2.2 Set the 4-20 mA Input Range

The 4-20 mA input range must be set to the exact same 4-20 mA output range of the 4-20 mA transmitter to be useful. To set the range of the 4-20 mA input:

- From the **4-20 mA IN** setup screen, press **"2"** **Set 4-20 mA RANGE**.

A screen will appear to set the secondary 4 and 20 mA values, for example:

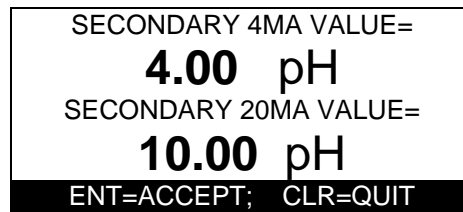

- Use the keypad to enter a value for the 4-mA point. Press **"ENT"**.
- Use the keypad to enter a value for the 20-mA point. Press **"ENT"**. The controller will return to the 4-20 MA INPUT screen.

6.5.6.2.3 Calibrate the 4-20 mA Input

The 4-20 mA input needs to be calibrated to the actual input to be accurate. A milliamp meter is necessary to calibrate the 4-20 mA input. Connect the milliamp meter in-line with one leg of the 4-20 mA input. Refer to the drawing in the back of this manual for wiring instructions.

- From the **4-20 mA Input** screen, press **"3"** **CALIBRATE**.



- Use the keypad to enter the milliamp reading from the milliamp meter. Press **"ENT"**. The controller will respond with a **"CALIBRATION COMPLETE"** message and return to the 4-20 MA IN/OUT SETUP screen.

6.5.7 The System Setup Menu

The system setup menu is used to set up the cell constant, temperature compensation, anti-flashing, enable or disable the conductivity input, initialize the controller, change the security password, check the firmware version and check the diagnostics.

| SYSTEM SETUP | |
|--------------|--------------------|
| ===== | |
| 1 | PROCESS PARAMETERS |
| 2 | INITIALIZATION |
| 3 | SECURITY |
| 4 | FIRMWARE VERSION |
| 5 | DIAGNOSTICS |

6.5.7.1 Process Parameters

The process parameters screen is used to set up the cell constant, temperature compensation, anti-flashing, and enable or disable the conductivity input.

6.5.7.1.1 Cell Constant

The conductivity sensor has a cell constant associated with it. The cell constant must be set up for the default conductivity value to be close to the actual conductivity.

To set up the cell constant:

- From the Main Menu press "7" **SYSTEM SETUP**.
- Press "1" **PROCESS PARAMETERS**.
- Press "1" **CELL CONSTANT**.
- Use the keypad to enter the cell constant for your conductivity sensor.

Below is a table of the Lakewood Instruments conductivity sensor cell constants that can be used with the model 1575e:

Table #1: Sensor Identification per Application

| Application | Sensor P/N's | Description | Cell Constant | Temp Comp. |
|---------------|--------------|----------------------------|---------------|------------|
| Cooling Tower | 1167157 | Sensor with 2 ft of cable | 1.000 | 500 NTC |
| Cooling Tower | 1167158 | Sensor with 20 ft of cable | 1.000 | |
| Boiler (SR) | 1168374 | Sensor with 20 ft of cable | 0.100 | NONE |
| Condensate | 1104591 | 540K.1-4-10I-10-TC500 | 0.100 | 500 NTC |
| Condensate | 1168617 | 540K.1-4-10R-18-TC500 | 0.100 | |
| Condensate | 1104592 | 540K.01-4-10I-10-TC500 | 0.010 | |
| Condensate | 1169642 | 540K.01-4-10R-18-TC500 | 0.010 | |

6.5.7.1.2 Temperature Compensation

All Lakewood Instruments conductivity sensors are temperature compensated with the exception of the SR type boiler sensor. The temperature compensation for your sensor must be set in the model 1575e controller. Refer to the table above for the temperature compensation values for the Lakewood Instruments conductivity sensors.

To set up the temperature compensation:

- From the Main Menu press "7" **SYSTEM SETUP.**
- Press "1" **PROCESS PARAMETERS.**
- Press "2" **TEMP COMPENSATION**
- Press "1" for **500 NTC.** Press "2" for **NONE.**

6.5.7.1.3 Anti-flashing

The anti-flashing menu selection inserts a damping circuit value into the conductivity circuit to slow down the rate of change of the conductivity when steam flashing is occurring. The anti-flashing should only be used when the model 1575e is used with the boiler sensor in a hot sample application.

To set up the anti-flashing:

- From the **Main Menu** press "7" **SYSTEM SETUP.**
- Press "1" **PROCESS PARAMETERS.**
- Press "3" **ANTI-FLASHING.**
- Press "1" **YES** to enable anti-flashing, press "2" **NO** to disable anti-flashing.

6.5.7.1.4 Enable or Disable the Conductivity Input

The Model 1575e can be used with or without the conductivity input. If conductivity is not being used, disable the conductivity input.

- From the **Main Menu** press "7" **SYSTEM SETUP.**
- Press "1" **PROCESS PARAMETERS.**

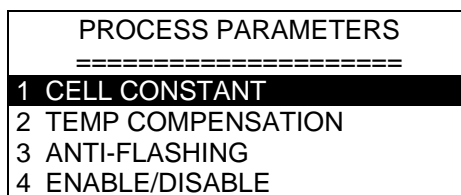

- Press "4" **ENABLE/DISABLE.**

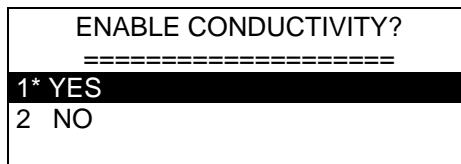

- Press "1" **YES** to enable the conductivity input or press "2" **NO** to disable the conductivity input.

6.5.7.2 Initialization

Initialization restores the factory default settings to the controller. The whole controller can be initialized or just the calibration of the conductivity or the secondary input. It is suggested that you initialize the whole controller before you program the controller. This will clear any random settings that may be in the controller. To do so, follow these instructions:

- From the **Main Menu**, press "7" **SYSTEM SETUP**.
- Press "2" **INITIALIZATION**.

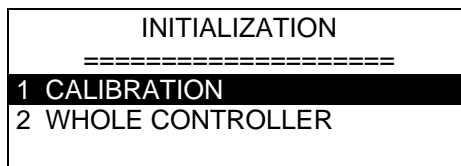

- Press "2" **WHOLE CONTROLLER** and press "ENT". A warning will appear on the screen (see below). Press "1" to proceed, "2" to cancel.

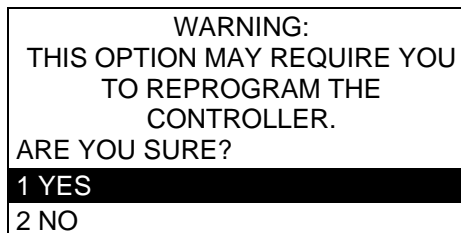

To initialize either of the calibrations:

- Press "1" **CALIBRATIONS** instead of "2" **WHOLE CONTROLLER** in the procedure above. A warning screen will appear:

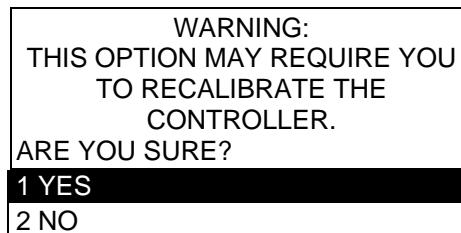

- Press “**1**” **YES** to enter the Initialize Calibration Screen below or press “**2**” **NO** to return to the Initialization screen.

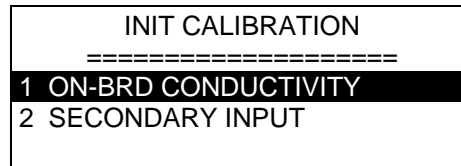

NOTE: The Secondary Input selection will only appear in this screen if the Secondary 4-20 mA input is enabled.

- Press “**1**” **ON-BRD CONDUCTIVITY** to initialize the conductivity input or press “**2**” **SECONDARY INPUT** to initialize the secondary input. The controller will respond with an “INITIALIZATION COMPLETE” message.

6.5.7.3 Change the Security Password

The security password can be changed from the factory default setting of 2222 to any four-digit value that you desire.

To change the security password:

- From the **Main Menu**, press “**7**” **SYSTEM SETUP**.
- Press “**3**” **SECURITY**.
- Use the keypad to enter the old password. If the password has not been changed before, the old password is **2222**.
- Use the keypad to enter the new password.
- Use the keypad to enter the new password a second time for verification

If you lose your password, contact Lakewood Instruments for assistance.

6.5.7.4 Firmware Version

Sometimes it is necessary to verify the firmware version of the controller for troubleshooting purposes. To get to the firmware version:

- From the **Main Menu**, press “**7**” **SYSTEM SETUP**.
- Press “**4**” **FIRMWARE VERSION**.
- The firmware version will be displayed along with a checksum value. The checksum value is used to verify that the program has not been corrupted. To exit this screen, press any key.

6.5.7.5 Diagnostics

The diagnostics screen is used for troubleshooting purposes. Contact Lakewood Instruments for assistance.

6.5.8 Setting the Clock

The clock uses the 24 hour or military time. 06:00:00 is 6 a.m. 18:00:00 is 6 p.m. To set the clock:

- From the **Main Menu** press **"8" CLOCK**. The following screen will appear:

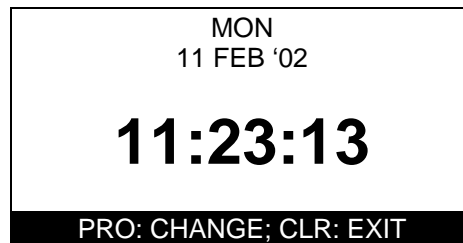

- Press **"PRO"** to change the clock settings.
- Use the up and down arrow keys to change the day of the week. Press **"ENT"**.
- Use the number keys to change the date. Press **"ENT"**.
- Use the arrow keys to change the month. Press **"ENT"**.
- Use the number keys to change the year. Press **"ENT"**.
- Use the number keys to change the hour. Press **"ENT"**.
- Use the number keys to change the minutes. Press **"ENT"**.
- Use the number keys to change the seconds. Press **"ENT"**.
- Press **"CLR"** to exit this screen.

You must press **"ENT"** all the way through this menu for the settings to take affect.

6.5.9 Changing the Security Levels

The security level can be change to prevent any unwanted tampering of the controller. To change the security level from **Technician** to **View-Only**:

- From the **Main Menu**, press **"0"**. (*Note that "0" does not appear on the menu screen.*)

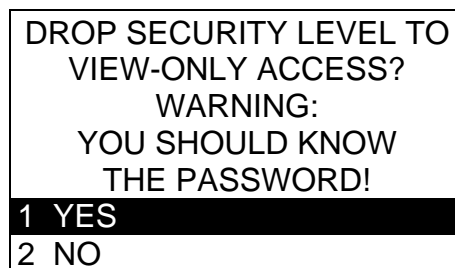

- Select **YES** to change the security level.



The controller menu now functions at the VIEW-ONLY security level.

To return to the **Technician** security level:

- Press the numeric password from the **Process** screen:



Remember that following the first power-up the Technician password is 2222. You may change the passwords in the SYSTEM SETUP menu.

7.0 Maintenance

Periodic maintenance is required to ensure trouble free operation of the model 1575e controller. The following sections cover the required maintenance.

7.1 Sensor Maintenance

Routine maintenance is necessary in order to maximize the efficiency and accuracy of your sensor. Clean the electrode end of the conductivity sensor at least once per month. Cleaning of the conductivity sensor may need to be performed more frequently if it is in a high fouling environment.

- Remove power from the controller and shut off the sample flow.
- Remove the sensor from its plumbing.
- Use a wire brush to lightly brush the sensor tips. Do not use cloth to clean the sensor tips. Cloth has oils that will foul the sensor.
- If there is oil on the sensor tips, use isopropyl alcohol to clean the tips.
- If there is scale on the sensor tips use a 10% Muriatic or HCL acid to clean the sensor.
- Wash the sensor off with tap water.
- Install the sensor in its plumbing.
- Restore sample flow and check for leaks.
- Restore power to the controller.
- Perform a calibration of the conductivity.

7.2 Flow Switch Maintenance

If you have the flow switch plumbing assembly, you may need to periodically clean the wetted parts in this assembly.

- Shut off the inlet flow and the power to the controller.
- Turn the red lock ring for the flow switch counterclockwise.
- Pull out the clear flowsight tube and remove the float with your fingers.
- Use a bottlebrush on the float, flowsight and the flow switch assembly to remove any residue.
- Clean and lubricate the “O” ring with a silicone-based lubricant (petroleum-based lubricants will cause the O-ring to swell).
- Lock down the red lock ring after you replace the components.
- Turn the inlet flow back on and check for leaks.

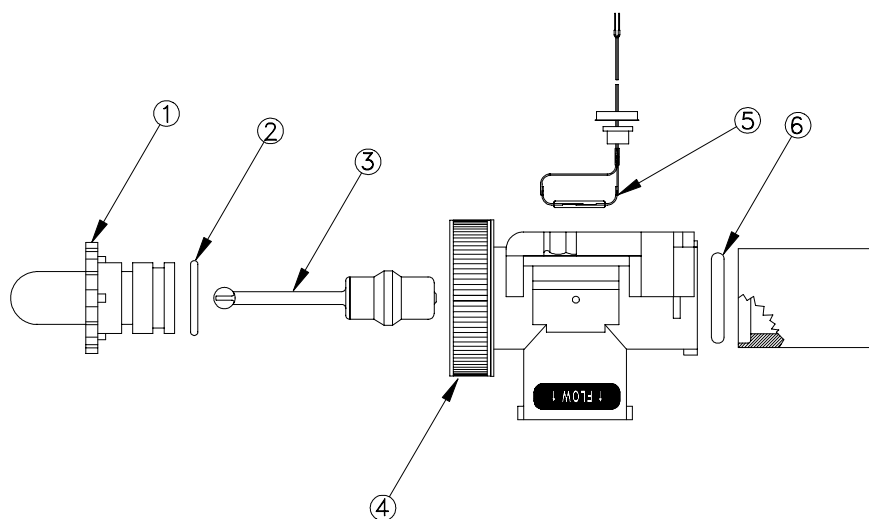

FlowSwitchAssembly, P/N 1107003

| Find No. | Part No. | Part Description |
|-----------------|-----------------|-------------------------|
| 1 | 1167266 | Flowsight |
| 2 | 1166418 | O-Ring (flow sight) |
| 3 | 1167234 | Flow Magnet |
| 4 | 1169740 | Red Locking Ring Kit |
| 5 | 1107004 | Reed Switch |
| 6 | 1166417 | O-Ring (check valve) |

Replacing the Reed Switch

If you ever need to replace the reed switch for the flow switch, follow the procedure below.

- Remove the power to the controller and shut off the sample flow.
- Disconnect the flow switch wires from the controller.
- Remove the screws holding the flow switch plumbing assembly.
- Move the flow switch plumbing assembly away from the wall.
- Pull hard on the wires that go to the reed switch assembly to remove the reed switch.
- Push the new reed switch into the plumbing assembly and wire the new reed switch to the controller.
- Re-install plumbing.
- Restore flow to the plumbing assembly and check for leaks.
- Restore power to the controller.

7.3 Replacing the Fuses

The Model 1575e contains a two 5 x 20 mm, European-style fuse. Replacement fuses must be a Schurter 0034.1526, Littlefuse 217.010, or equivalent 10A, 250V, fast blow type for Fuse F1 and a Littlefuse 218.100, Schurter 0034.3107, or equivalent 100mA, slow blow for Fuse F2. If a fuse is blown, the display will be blank when the unit is connected to power. Refer to the troubleshooting section of this manual for more information about blank displays.

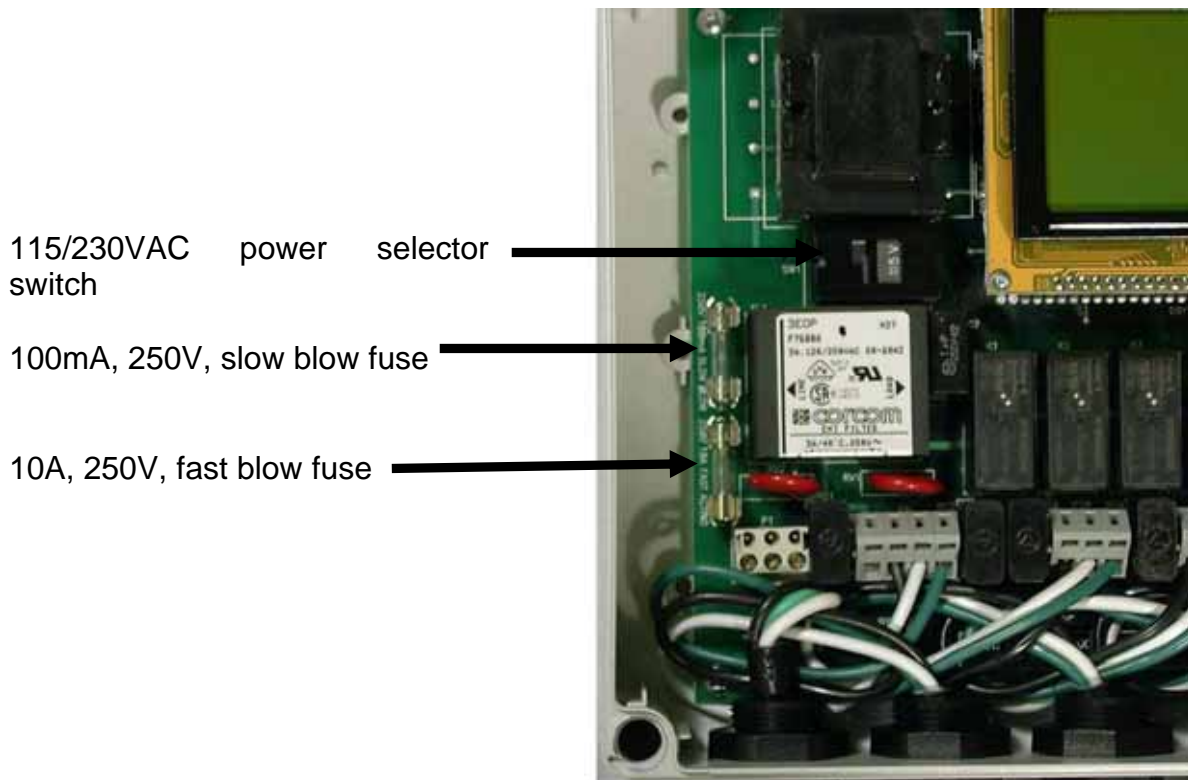

8.0 Troubleshooting

8.1 Error Messages

This section discusses some of the more common questions with the Model 1575e. These notes are not intended to be all-inclusive—only to cover the most common situations. If you have other questions or are need support, contact the Lakewood Instruments Technical Service Department toll free at (800) 228-0839.

| PROBLEM | WHAT THIS MEANS | CORRECTIVE ACTION |
|---|--|---|
| {Alarm Flashing} “CONDUCTIVITY HIGH”. | Conductivity is too high with respect to the high alarm setpoint. Also opens up Bleed Valve (useful during FEED SCHEDULE lockout). | <ol style="list-style-type: none"> 1. See {BLOWDOWN TIMEOUT}. 2. Change the High Alarm Value. |
| {Alarm Flashing} “CONDUCTIVITY LOW”. | Conductivity is too low with respect to the low alarm setpoint. | <ol style="list-style-type: none"> 1. Check blowdown setpoint and deadband. 2. Verify blowdown valve is not stuck open. 3. Change the Low Alarm Value. 4. Insure the system is not overflowing. |
| Water meters not accumulating. | <p>There may be a problem with the wiring or the reed switch in the meter may be bad.</p> <p>For water meters other than the contacting head type, check the manufacturer’s user manual for that particular water meter.</p> | <ol style="list-style-type: none"> 1. Approximately 5 volts DC should be present at the input terminal when the water meter contact is closed. That should change to zero VDC when the contact opens. Check these voltages and for correct wiring. 2. Is the controller configured for your type of water meter? |
| {Alarm Flashing} “FEED SEQUENCE ACTIVE”. | This simply indicates that a feed schedule relay is active. | No action necessary. |
| Display is blank. | There may be a problem with the incoming power, the fuses or the circuit board. Open the front panel to troubleshoot. | <ol style="list-style-type: none"> 1. Check the fuse F1. Replace with 5 x 20 mm, 10A, 250V, fast blow fuse. 2. Check the fuse F2. Replace with 5 x 20 mm, 100mA, 250V, slow blow fuse. 3. Does the unit have power? 4. If there is power to terminals AC and ACC on P1, call Lakewood Instruments Technical Service for more information. |
| “NO FLOW” alarm. | Flow input switch is not closed. | <ol style="list-style-type: none"> 1. The flow switch float may be stuck or no flow is present. 2. Flow switch may be bad. Replace reed switch in plumbing assembly. <p>If no flow switch is used, a jumper wire should be installed across the flow switch input. Removing the jumper disables all relay outputs.</p> |

| PROBLEM | WHAT THIS MEANS | CORRECTIVE ACTION |
|---|--|---|
| <p>{Alarm Flashing} “BLOWDOWN TIMEOUT”.</p> | <p>This indicates that the controller has been trying to reduce the conductivity for longer than the user-programmed time and is unable to reach the setpoint.</p> | <ol style="list-style-type: none"> 1. Check for proper operation of the blowdown valve. Use the manual relay control to help. 2. Check that the blowdown valve is not stuck closed or restricted. 3. Check for proper makeup flow. 4. Verify blowdown timeout time is properly set for your application (see item #2 or RELAYS in MAIN menu). |
| <p>{Alarm Flashing} “OPENED TC”.</p> | <p>Temperature compensator not being properly read.</p> | <ol style="list-style-type: none"> 1. Check wiring. 2. Replace conductivity sensor. |
| <p>{Alarm Flashing} “SHORTED TC”.</p> | <p>Temperature compensator not being properly read.</p> | <ol style="list-style-type: none"> 1. Check wiring. 2. Replace conductivity sensor. |
| <p>Motorized ball valve functions, but will not remain “open” or “closed” as expected.</p> | <p>The motorized ball valve is not indicating to the 1575e that it has actually reached the open or closed position.</p> | <p>Adjust the limit switch for the motorized ball valve.</p> |

9.0 Factory Service



Technical Support for Lakewood Instruments can be reached by calling (800) 228-0839 or faxing (414) 355-3508, Monday through Friday, 7:30 a.m. - 5:00 p.m. CST.

NOTE: IF YOU CALL FOR TROUBLESHOOTING HELP, PLEASE HAVE THE MODEL NUMBER, SERIAL NUMBER, AND ANY OPTIONS PERTAINING TO YOUR UNIT AVAILABLE FOR REFERENCE.



Mail and returns should be sent to:

**Lakewood Instruments
7838 North Faulkner Road
Milwaukee, WI 53224 USA**

When any merchandise is to be returned to the factory, please call and obtain a Return Goods Authorization (RGA) number and have the following information available:

- Customer's name, address, telephone and fax numbers (shipping and billing).
- A hard copy purchase order number for cases where repairs or parts are required that are not under warranty.
- A contact person's name and telephone number to call if the equipment is beyond repair or to discuss any other warranty matter.
- Equipment model and serial numbers.
- Reason for return, e.g., repair, warranty, incorrect part, etc.

We will then fax to your attention an RGA form that must accompany the returned item.

NOTE: THE RGA NUMBER MUST BE CLEARLY WRITTEN ON THE OUTSIDE OF THE PACKAGE(S) BEING RETURNED.

**ANY ITEMS SENT BACK TO THE FACTORY
WITHOUT AN RGA NUMBER WILL BE REFUSED
AND RETURNED TO SENDER**

Parts List and Service Guide

When calling Lakewood Instruments, please have your controller's complete model number and serial number available, together with the firmware version so that the Technician can better assist you.

Refer to the Ordering Information section of this manual for part numbered replacement parts.

Write your controller's complete model number, serial number, and firmware version here so that you will have them available if you wish to contact a Lakewood Instruments technician.

Model Number:

Serial Number:

Firmware Version:

10.0 Drawings

| REVISION | | REVISION HISTORY | | | |
|----------|------|------------------|------|-------------|-----------|
| DWG | PART | DESCRIPTION | ECO | DWN/DATE | APVD/DATE |
| A | A | RELEASE | 6975 | DGK/8/15/02 | |

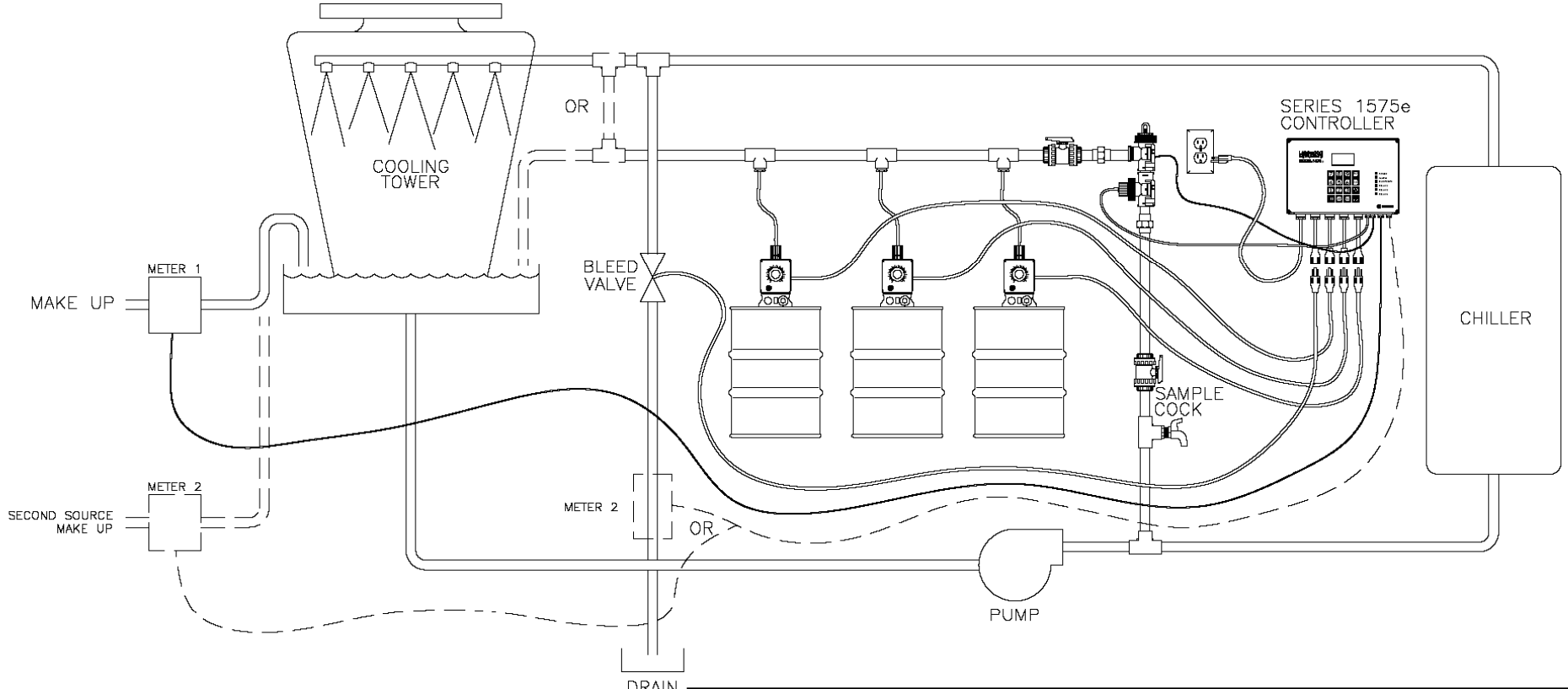

| | | | |
|---|--|--|---------------------------------|
| <p>NOTICE ON REPRODUCTIONS THIS DRAWING, THE DESIGN AND THE PATENTS IT COVERS, ARE THE PROPERTY OF USMONICS INC. THEY ARE LOANED MERELY AND ON THE BORROWER'S EXPRESS AGREEMENT THAT THEY WILL NOT BE REPRODUCED, COPIED, LOANED, EXHIBITED, NOR USED EXCEPT IN THE LIMITED WAY AND THE PRIVATE USE PERMITTED BY WRITTEN CONSENT GIVEN BY THE LENDER TO THE BORROWER.</p> | | | |
| <p>DIMENSIONING AND TOLERANCING PER ASME Y14.5M-1994</p> | | <p>TITLES</p> <p>INSTALLATION DRAWING COOLING TOWER,1575e</p> | |
| <p>MATERIAL</p> <p>N/A</p> | <p>TOLERANCES UNLESS NOTED</p> <p>DECIMALS ± .X ± .XX ± .XXX ±</p> <p>ANGLES ± SURFACE ±</p> | <p>SIZE</p> <p>B</p> | <p>PN</p> <p>1229239</p> |
| <p>FINISH</p> <p>N/A</p> | <p>DWN DGK DATE 8/15/02</p> <p>CHKD DATE</p> | <p>THIRD ANGLE</p> | <p>REV</p> <p>A</p> |
| <p>PROJECT: N/A</p> | <p>APVD DATE</p> | <p>SCALE</p> <p>NTS</p> | <p>DWG NO</p> <p>1229239-1a</p> |
| <p>LIBRARY: N/A</p> | <p>PART VERSION N/A</p> | <p>SHEET</p> <p>1 OF 1</p> | <p>REV</p> <p>A</p> |

| REVISION | | REVISION HISTORY | | | |
|----------|------|------------------|------|-------------|-----------|
| DWG | PART | DESCRIPTION | ECD | DWN/DATE | APVD/DATE |
| A | A | RELEASE | 6975 | DGK/8/15/02 | |

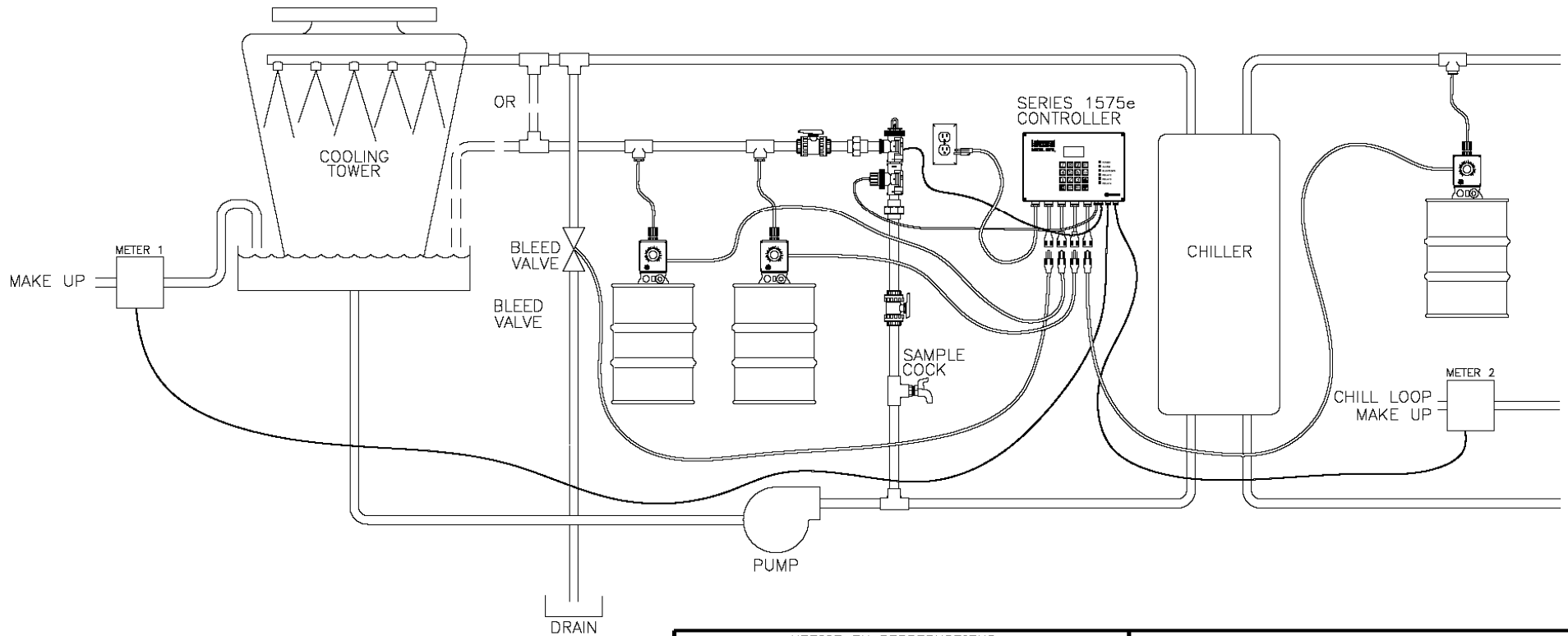

| | | | | | | | | | | | |
|---|---|--|---------|------|---------|--|---|--|------------------------------------|--|------------------------------------|
| <p align="center">NOTICE ON REPRODUCTIONS</p> <p>THIS DRAWING, THE DESIGN AND THE PATENTS IT COVERS, ARE THE PROPERTY OF DISMUNICS INC. THEY ARE LOANED MERELY AND ON THE BORROWER'S EXPRESS AGREEMENT THAT THEY WILL NOT BE REPRODUCED, COPIED, LOANED, EXHIBITED, NOR USED EXCEPT IN THE LIMITED WAY AND THE PRIVATE USE PERMITTED BY WRITTEN CONSENT GIVEN BY THE LENDER TO THE BORROWER.</p> | | | | | | | | | | | |
| <p align="center">DIMENSIONING AND TOLERANCING PER ASME Y14.5M-1994</p> | | <p align="center">TITLE</p> <p align="center">INSTALLATION DRAWING CHILL LOOP/COOLING TOWER, 1575e</p> | | | | | | | | | |
| <p>MATERIAL</p> <p align="center">N/A</p> | <p>TOLERANCES UNLESS NOTED</p> <table border="0"> <tr> <td>DECIMALS</td> <td>ANGLES</td> </tr> <tr> <td>X ±</td> <td>±</td> </tr> <tr> <td>.XX ±</td> <td>SURFACE</td> </tr> <tr> <td>.XXX ±</td> <td>✓</td> </tr> </table> | DECIMALS | ANGLES | X ± | ± | .XX ± | SURFACE | .XXX ± | ✓ | <p>SIZE</p> <p align="center">B</p> <p>THIRD ANGLE</p> | |
| DECIMALS | ANGLES | | | | | | | | | | |
| X ± | ± | | | | | | | | | | |
| .XX ± | SURFACE | | | | | | | | | | |
| .XXX ± | ✓ | | | | | | | | | | |
| <p>FINISH</p> <p align="center">N/A</p> | <table border="0"> <tr> <td>DWN</td> <td>DGK</td> <td>DATE</td> <td>8/15/02</td> </tr> <tr> <td>CHKD</td> <td></td> <td>DATE</td> <td></td> </tr> </table> | DWN | DGK | DATE | 8/15/02 | CHKD | | DATE | | <p>PN</p> <p align="center">1229239</p> | <p>REV</p> <p align="center">A</p> |
| DWN | DGK | DATE | 8/15/02 | | | | | | | | |
| CHKD | | DATE | | | | | | | | | |
| <p>PROJECT: N/A</p> <p>LIBRARY: N/A</p> | <table border="0"> <tr> <td>APVD</td> <td>DATE</td> </tr> <tr> <td></td> <td></td> </tr> </table> | APVD | DATE | | | <p>SCALE</p> <p align="center">NTS</p> | <p>SHEET</p> <p align="center">1 OF 1</p> | <p>DWG NO</p> <p align="center">1229239-2a</p> | <p>REV</p> <p align="center">A</p> | | |
| APVD | DATE | | | | | | | | | | |
| | | | | | | | | | | | |

NOTES: UNLESS OTHERWISE SPECIFIED;

1. ORIFICE UNIONS MUST BE INSTALLED TO PREVENT STEAMFLASH. REFER TO USER MANUAL 1106840 FOR PROPER ORIFICE SIZING.

2. SENSOR MUST BE MOUNTED HORIZONTALLY AND MUST BE AT LEAST 2 FEET BELOW THE WATER LEVEL OF THE BOILER. THE DISTANCE FROM THE SENSOR TO THE ORIFICE UNION MUST BE 5 FEET OR LESS.

3. THE 1575e MUST BE LOCATED WITHIN 20 FEET OF THE BOILER SENSOR AND AS FAR FROM HEAT AS POSSIBLE.

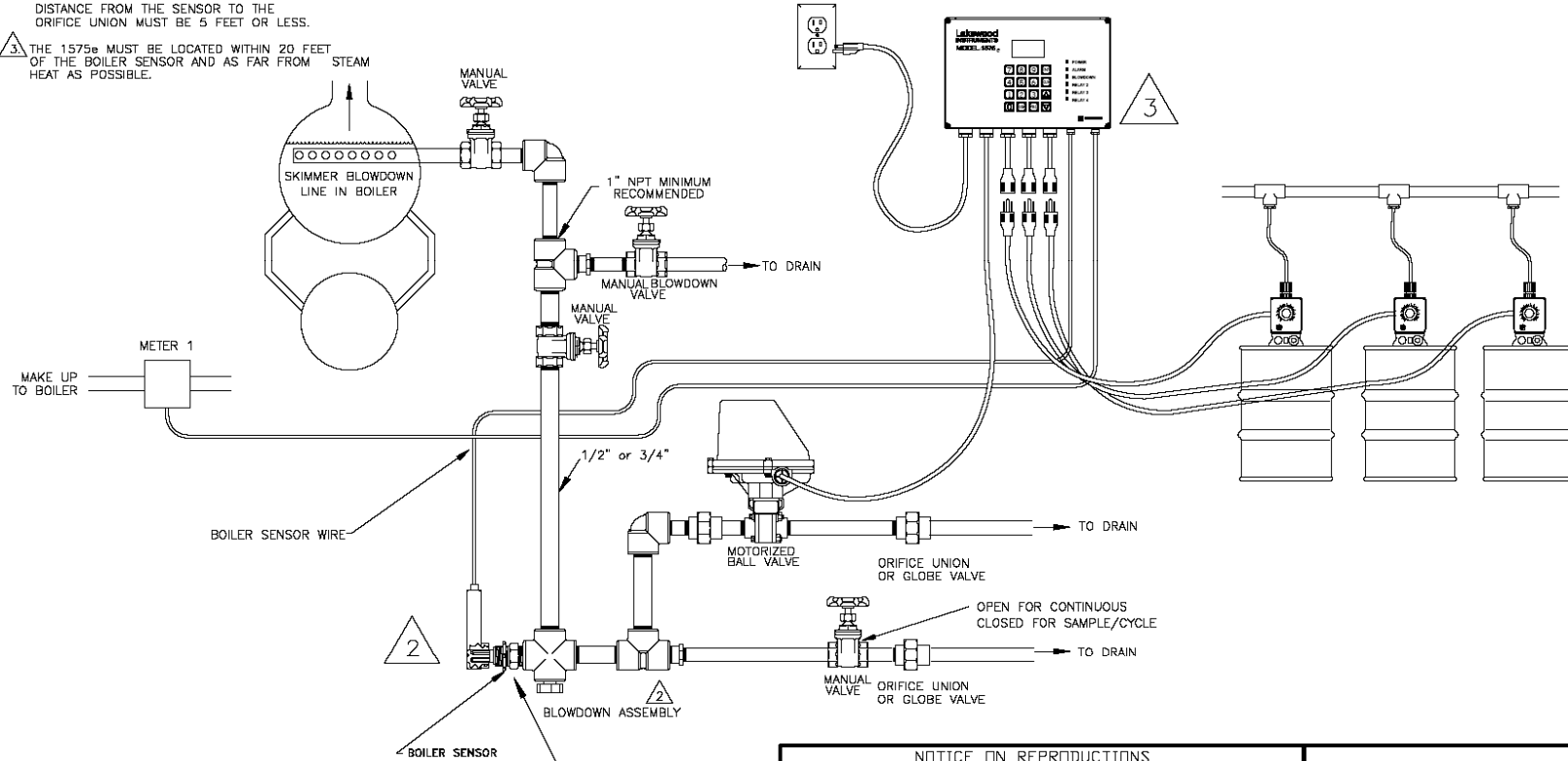

SENSOR MUST BE MOUNTED HORIZONTALLY AND MUST BE AT LEAST 2 FEET BELOW THE WATER LEVEL OF THE BOILER. THE DISTANCE FROM THE SENSOR TO THE ORIFICE UNION MUST BE 5 FEET OR LESS.

| REVISION | | REVISION HISTORY | | | |
|----------|------|------------------|------|-------------|-----------|
| DWG | PART | DESCRIPTION | ECD | DWN/DATE | APVD/DATE |
| A | A | RELEASE | 6975 | DGK/9/16/02 | |

NOTICE ON REPRODUCTIONS
THIS DRAWING, THE DESIGN AND THE PATENTS IT COVERS, ARE THE PROPERTY OF OSMONICS INC. THEY ARE LOANED MERELY AND ON THE BORROWER'S EXPRESS AGREEMENT THAT THEY WILL NOT BE REPRODUCED, COPIED, LOANED, EXHIBITED, NOR USED EXCEPT IN THE LIMITED WAY AND THE PRIVATE USE PERMITTED BY WRITTEN CONSENT GIVEN BY THE LENDER TO THE BORROWER.

| DIMENSIONING AND TOLERANCING PER ASME Y14.5M-1994 | |
|---|---|
| MATERIAL N/A | TOLERANCES UNLESS NOTED DECIMALS .X ± .XX ± .XXX ± ANGLES ± SURFACE ✓ |
| FINISH N/A | DWN DGK DATE 9/16/02 CHKD DATE |
| PROJECT: N/A | APVD DATE |
| LIBRARY: N/A | PART VERSION N/A |



| TITLE | |
|---|-----------------|
| INSTALLATION LAYOUT CONTINUOUS OR SAMPLE/CYCLE, M-1575e | |
| SIZE B | PN 1229239 |
| SCALE NTS | SHEET 1 OF 1 |
| DWG NO 1229239-3a | |
| REV A | REV A |

| REVISION | | REVISION HISTORY | | | |
|----------|------|------------------|------|-------------|---------|
| DWG | PART | DESCRIPTION | ECO | DWDATE | APVDATE |
| A | A | RELEASE | 6377 | DGK/23JAN02 | |

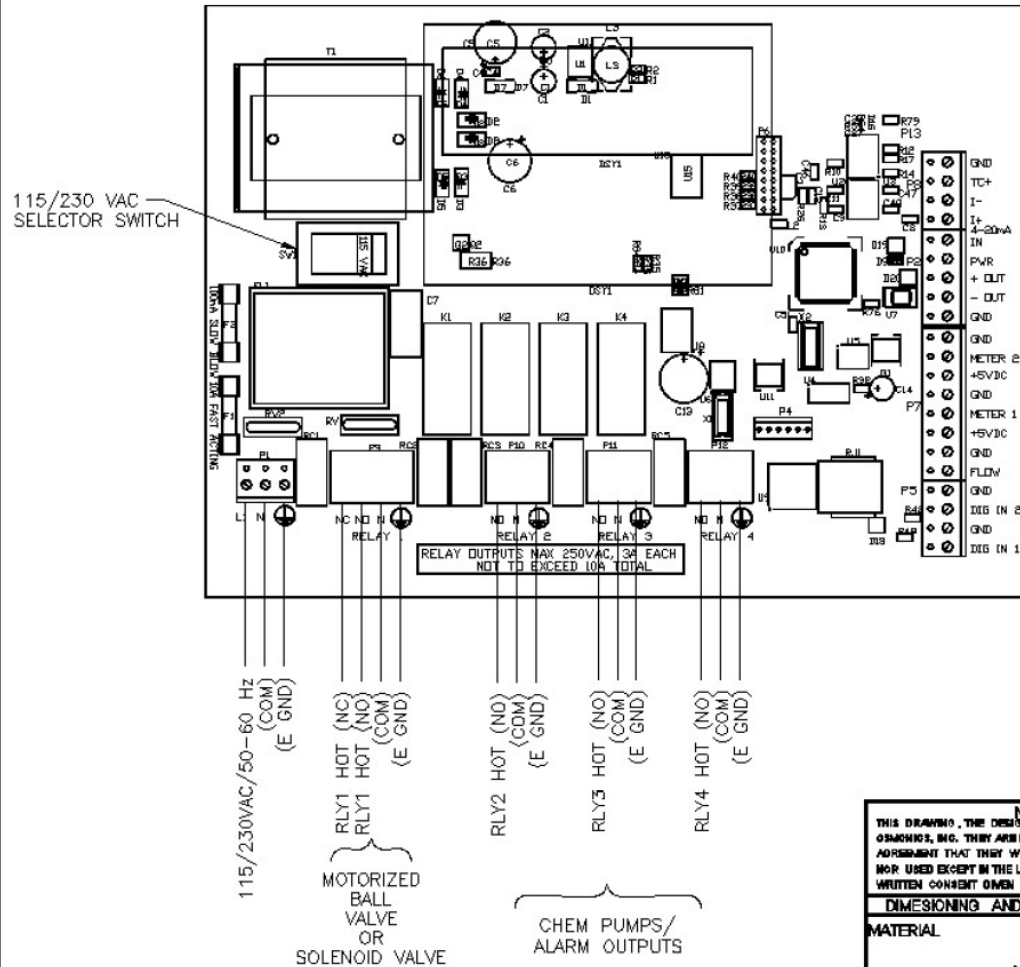

| NOTICE ON REPRODUCTIONS | | | | Lakewood INSTRUMENTS | |
|--|-----|-------------------------|--------------|------------------------------|--------------------|
| THIS DRAWING, THE DESIGN AND THE NAMES OF TOOLS ARE THE PROPERTY OF OSBORN, INC. THEY ARE LOANED LIBRALLY AND ON THE BORROWER'S EXPRESS AGREEMENT THAT THEY WILL NOT BE REPRODUCED, COPIED, LOANED, QUOTED, NOR USED EXCEPT IN THE LIMITED WAY AND THE PRIVATE USE PERMITTED BY WRITTEN CONSENT GIVEN BY THE LENDER TO THE BORROWER. | | | | | |
| DIMENSIONING AND TOLERANCING PER ASME Y14.5M - 1994 | | | | | |
| MATERIAL | N/A | TOLERANCES UNLESS NOTED | | TITLE | |
| | | DECIMALS | ANGLES | WIRING DIAGRAM FOR THE 1575e | |
| | | .X ± | ± | POWER CONNECTIONS | |
| | | .XX ± | SURFACE | SIZE | PN |
| FINISH | N/A | DWN D.GK | DATE 23JAN02 | B | 1229239 |
| | | CHKD | DATE | THIRD ANGLE | |
| PROJECT | | APVD | DATE | SCALE | DWG NO. 1229239-4a |
| LIBRARY: | | PART VERSION | | SHEET | REV |
| | | | | 1 OF 1 | A |

NOTES: UNLESS OTHERWISE SPECIFIED;
 ⚠ IF NO FLOW SWITCH IS USED, SHORT OUT PINS 1 & 2 WITH WIRE.

| REVISION | | REVISION HISTORY | | | |
|----------|------|------------------|------|-------------|-----------|
| DWG | PART | DESCRIPTION | ECO | DWN/DATE | APVD/DATE |
| A | A | RELEASE | 6377 | DGK/23JAN02 | |

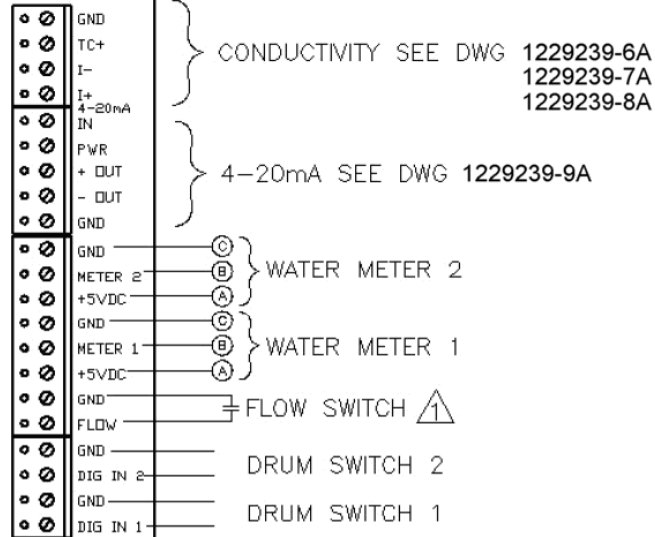
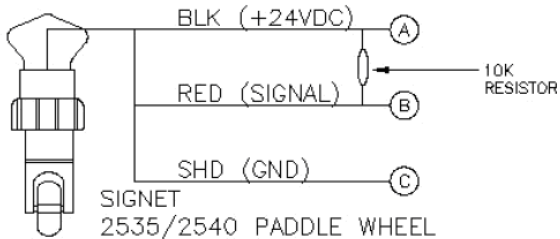
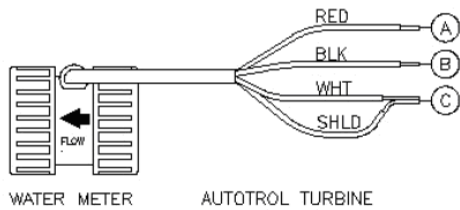
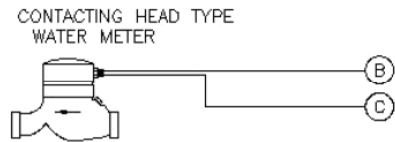

| NOTICE ON REPRODUCTIONS | | Lakewood INSTRUMENTS | | |
|---|---------------------|---|----------------------|------------|
| THIS DRAWING, THE DESIGN AND THE PATENTS IT COVERS, ARE THE PROPERTY OF GEMCONICS, INC. THEY ARE LOANED MERELY AND ON THE BORROWER'S EXPRESS AGREEMENT THAT THEY WILL NOT BE REPRODUCED, COPIED, LOANED, SOLETTED, NOR USED EXCEPT IN THE LIMITED WAY AND THE PRIVATE USE PERMITTED BY WRITTEN CONSENT GIVEN BY THE LENDER TO THE BORROWER. | | TITLE WIRING DIAGRAM FOR WATER METER INPUTS ON THE 1575e | | |
| DIMENSIONING AND TOLERANCING PER ASME Y14.5M - 1994 | | REV A | | |
| MATERIAL | N/A | TOLERANCES UNLESS NOTED DIM: .X ± .XX ± .XXX ± | ANGLE ± SURFACE ✓ | PN 1229239 |
| FINISH | N/A | DWN: DGK CHKD: _____ | DATE: 23JAN02 | SCALE: B |
| PROJECT: | APVD: _____ | DATE: _____ | SHEET: 1 OF 1 | REV A |
| LIBRARY: | PART VERSION: _____ | DWG NO. 1229239-5a | | |

NOTES: UNLESS OTHERWISE SPECIFIED;
 ⚠ MAXIMUM DISTANCE FROM SENSOR TO CONTROLLER IS 20 FEET.

| REVISION | | REVISION HISTORY | | | |
|----------|------|------------------|------|-------------|-------------|
| DWG | PART | DESCRIPTION | ECO | DWN/DATE | APVD/DATE |
| A | A | RELEASE | 6377 | DGK/23JAN02 | LRS/23JAN02 |

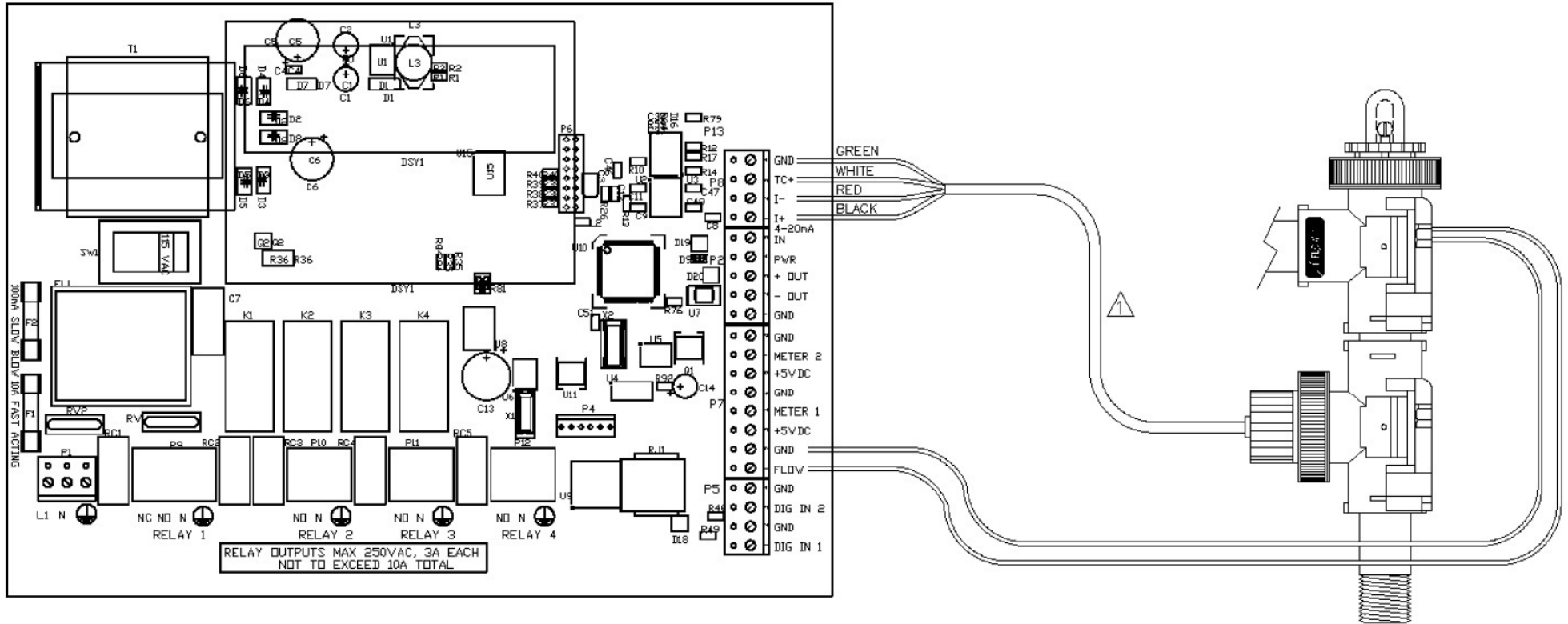

| NOTICE ON REPRODUCTIONS | | | | Lakewood INSTRUMENTS | | |
|---|-----|-------------------------|---------|--|------------|--------------------|
| THIS DRAWING, THE DESIGN AND THE PATENT IT COVERS, ARE THE PROPERTY OF OSMOND, INC. THEY ARE LOANED MERELY AND ON THE BORROWER'S EXPRESS AGREEMENT THAT THEY WILL NOT BE REPRODUCED, COPIED, LOANED, DOWNGRADED, NOR USED EXCEPT IN THE LIMITED WAY AND THE FRAME USE PERMITTED BY WRITTEN CONSENT GIVEN BY THE LENDER TO THE BORROWER. | | | | | | |
| DIMENSIONING AND TOLERANCING PER ASME Y14.5M-1994 | | | | TITLE COOLING TOWER SENOR WIRING FOR THE 1575e | | |
| MATERIAL | N/A | TOLERANCES UNLESS NOTED | | SIZE | PN 1229239 | REV A |
| | | DECIMALS | ANGLES | B | | |
| | | .X ± | ± | | | |
| | | .XX ± | SURFACE | | | |
| | | .XXX ± | | | | |
| FINISH | N/A | DWN | DGK | DATE | 23JAN02 | SCALE NTS |
| | | CHKD | REP | DATE | 23JAN02 | |
| PROJECT: | | APVD | LRS | DATE | 23JAN02 | DWG NO. 1229239-6a |
| LIBRARY: | | PART VERSION | | | | REV A |

| REVISION | | REVISION HISTORY | | | |
|----------|------|----------------------------|-------|-------------|-----------|
| DWG | PART | DESCRIPTION | ECO | DWN/DATE | APVD/DATE |
| C | A | RELEASE | 10127 | PSG 5-24-11 | |
| D | A | REMOVED TERMINAL BLOCK P13 | | PSG 8/18/11 | |

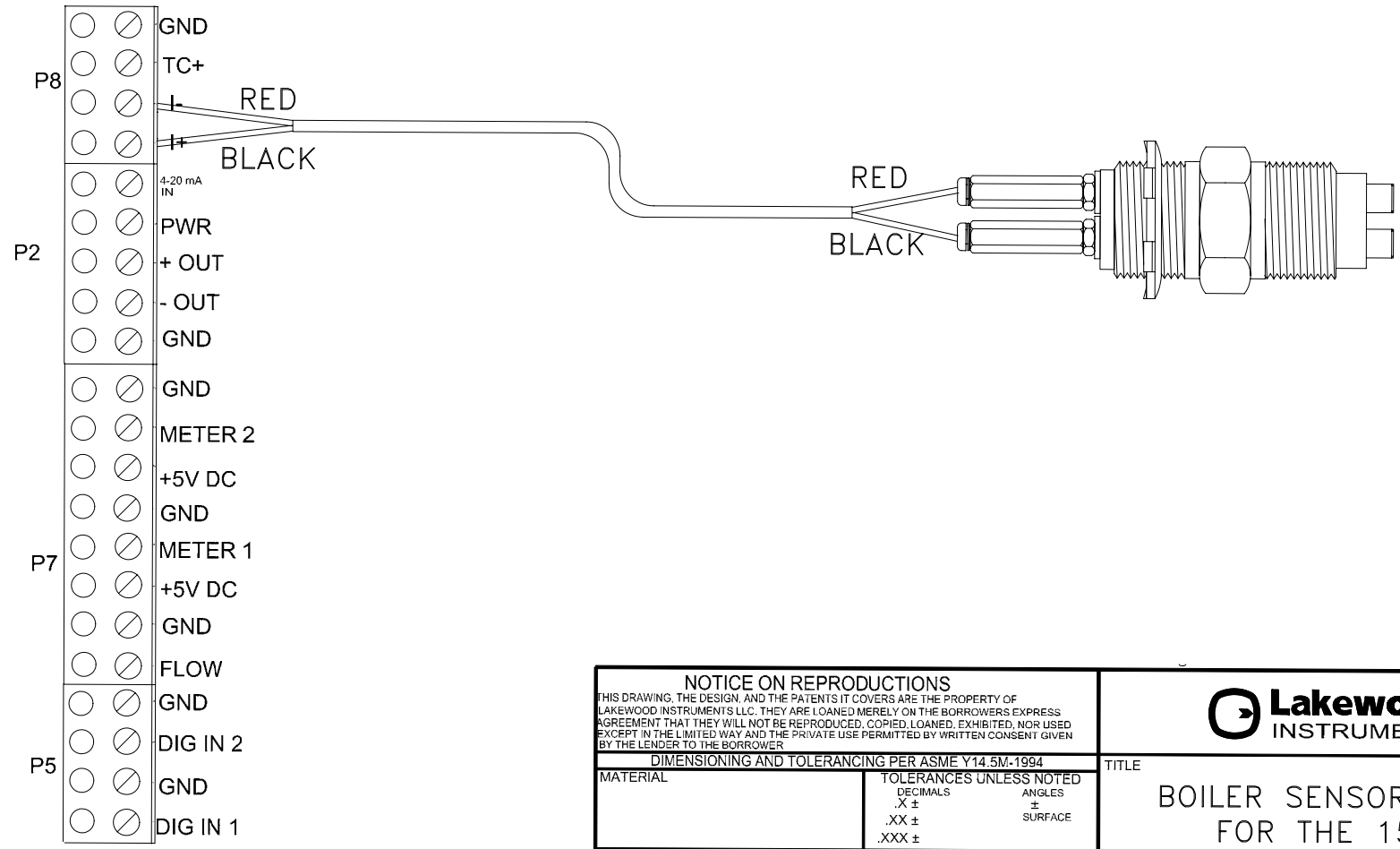

| | | | | | | | |
|---|--|------|----------|---|--|--------------------------|---------------------|
| <p align="center">NOTICE ON REPRODUCTIONS</p> <p>THIS DRAWING, THE DESIGN, AND THE PATENTS IT COVERS ARE THE PROPERTY OF LAKEWOOD INSTRUMENTS LLC. THEY ARE LOANED MERELY ON THE BORROWERS EXPRESS AGREEMENT THAT THEY WILL NOT BE REPRODUCED, COPIED, LOANED, EXHIBITED, NOR USED EXCEPT IN THE LIMITED WAY AND THE PRIVATE USE PERMITTED BY WRITTEN CONSENT GIVEN BY THE LENDER TO THE BORROWER.</p> | | | | | | | |
| <p align="center">DIMENSIONING AND TOLERANCING PER ASME Y14.5M-1994</p> | | | | <p align="center">TITLE</p> <p align="center">BOILER SENSOR WIRING FOR THE 1575e</p> | | | |
| MATERIAL | <p>TOLERANCES UNLESS NOTED</p> <p>DECIMALS ANGLES</p> <p>.X ± ±</p> <p>.XX ± SURFACE</p> <p>.XXX ±</p> | | FINISH | <p>DWN PSG DATE 1-23-07</p> <p>CHKD DATE</p> | <p>SIZE</p> <p>B</p> <p>THIRD ANGLE</p> | <p>PN</p> <p>1229239</p> | <p>REV</p> <p>A</p> |
| PROJECT: | APVD | DATE | LIBRARY: | SCALE | SHEET | DWG NO | REV |
| | | | | NTS | 1/1 | 1229239_7d | D |

NOTES: UNLESS OTHERWISE SPECIFIED;

△ MAXIMUM DISTANCE FROM SENSOR TO CONTROLLER IS 20 FEET.

| REVISION | | REVISION HISTORY | | | |
|----------|------|------------------|------|-------------|-----------|
| DWG | PART | DESCRIPTION | ECO | DW/DATE | APVD/DATE |
| A | A | RELEASE | 6377 | DGK/23JAN02 | |

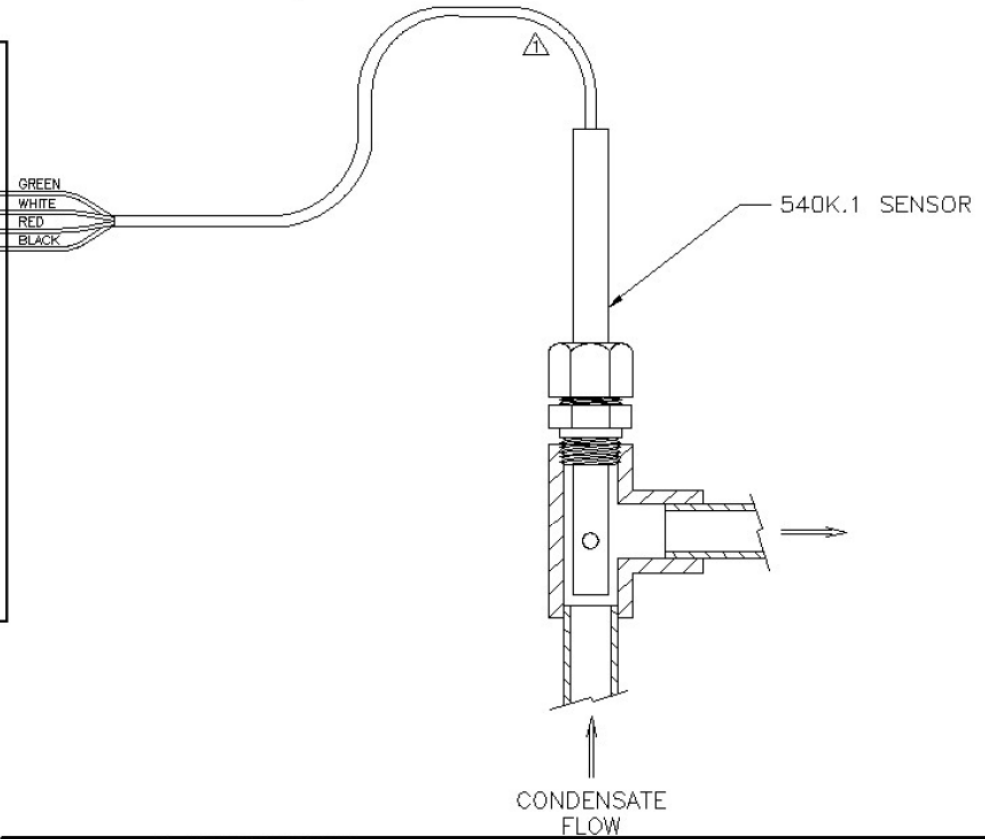
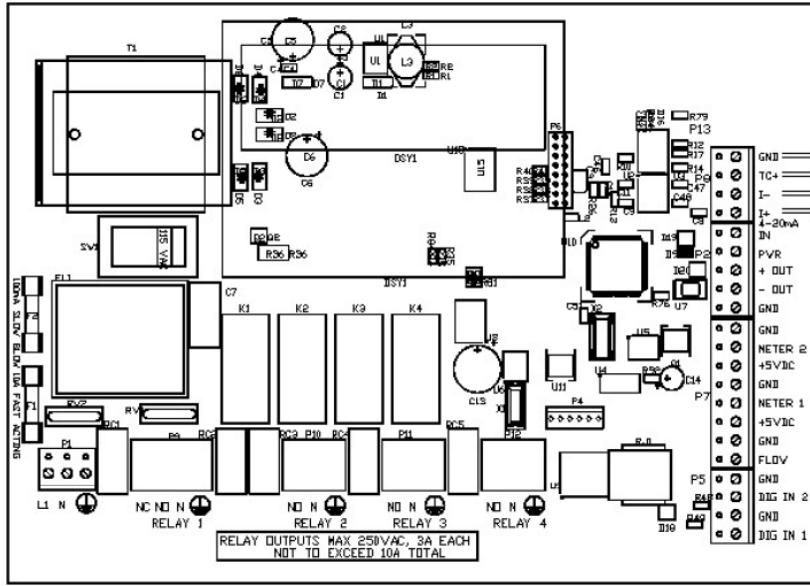

| NOTICE ON REPRODUCTIONS | | | | Lakewood INSTRUMENTS | | |
|---|-----|-------------------------|---------|---|--------------------|-----|
| THIS DRAWING, THE DESIGN AND THE FIGURES IF ANY, ARE THE PROPERTY OF OSBORNE, INC. THEY ARE LOANED LIBRALLY AND ON THE BORROWER'S EXPRESS AGREEMENT THAT THEY WILL NOT BE REPRODUCED, COPIED, LOANED, REHITED, NOR USED EXCEPT IN THE LIMITED WAY AND THE PRIVATE USE PERMITTED BY WRITTEN CONSENT GIVEN BY THE LENDER TO THE BORROWER. | | | | TITLE 540K.1 SENSOR WIRING FOR THE 1575e | | |
| DIMENSIONING AND TOLERANCING PER ASME Y14.5M - 1994 | | | | | | |
| MATERIAL | N/A | TOLERANCES UNLESS NOTED | | SIZE | PN | |
| | | DECIMALS | ANGLES | B | 1229239 | |
| | | .X ± | ± | THIRD ANGLE | | REV |
| | | .XX ± | SURFACE | SCALE | A | |
| | | .XXX ± | | NTS | 1 OF 1 | |
| FINISH | N/A | DWN DGK | DATE | 23JAN02 | DWG NO. 1229239-8a | |
| | | CHKD | DATE | | REV | |
| PROJECT | | APVD | DATE | | A | |
| LIBRARY | | PART VERSION | | | | |

NOTES: UNLESS OTHERWISE SPECIFIED;
 FOR INTERNAL 24VDC JUMPER WIRE IS REQUIRED.

| REVISION | | REVISION HISTORY | | | |
|----------|------|------------------|------|-------------|-----------|
| DWG | PART | DESCRIPTION | ECC | DW/DATE | APVD/DATE |
| A | A | RELEASE | G377 | DGK/23JAN02 | |

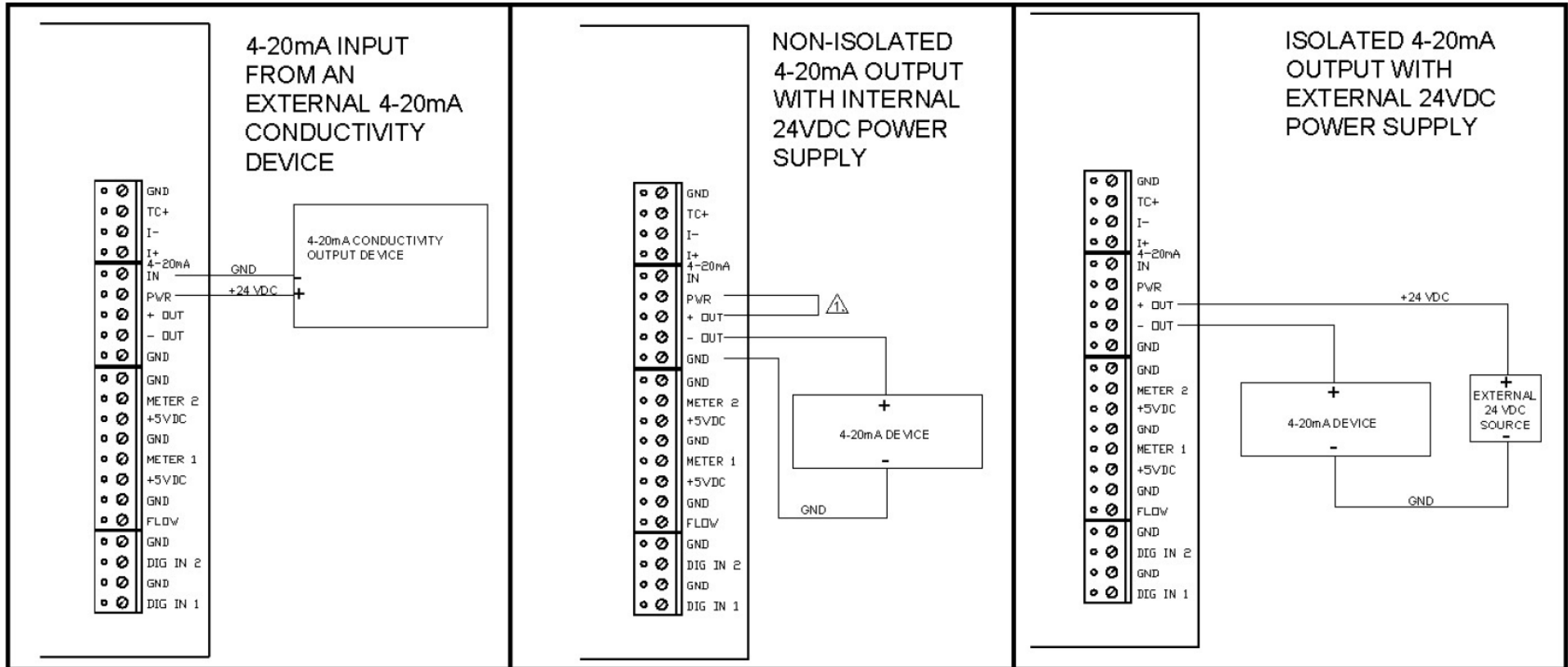

NOTICE ON REPRODUCTIONS
 THIS DRAWING, THE DESIGN AND THE PATENT RIGHTS HEREIN, ARE THE PROPERTY OF OMBRONICS, INC. THEY ARE LOANED LIBERALLY AND ON THE BORROWER'S EXPRESS AGREEMENT THAT THEY WILL NOT BE REPRODUCED, COPIED, LOANED, REPRODUCED, NOR USED EXCEPT IN THE LIMITED WAY AND THE PRIVATE USE PERMITTED BY WRITTEN CONSENT GIVEN BY THE LENDER TO THE BORROWER.



DIMENSIONING AND TOLERANCING PER ASME Y14.5M - 1994

| | | |
|----------|-----------------------------------|----------------|
| MATERIAL | TOLERANCES UNLESS NOTED OTHERWISE | |
| N/A | DECIMALS | ANGLES SURFACE |
| | .X ± | ± |
| | .XX ± | |
| | .XXX ± | |
| FINISH | DWG | DATE |
| N/A | DGK | 23JAN02 |
| PROJECT: | CHKD | DATE |
| | APVD | DATE |
| LIBRARY: | PART | VERSION |

| | | | | | |
|-----------------------------|---|------------|-----|-----|--|
| TITLE | | | | REV | |
| 4-20mA WIRING FOR THE 1575e | | | | A | |
| SIZE |  | PN | REV | | |
| B | | 1229239 | A | | |
| SCALE | SHEET | DWG NO. | REV | | |
| NTS | 1 OF 1 | 1229239-9a | A | | |

NOTES

- (A) RED (V+)
 - (B) BLACK (V-)
 - (C) ORANGE
 - (D) BROWN
- FLUOROMETER WIRING

- (E) BLACK
 - (F) RED
- 4-20 mA WIRING TO 1575e

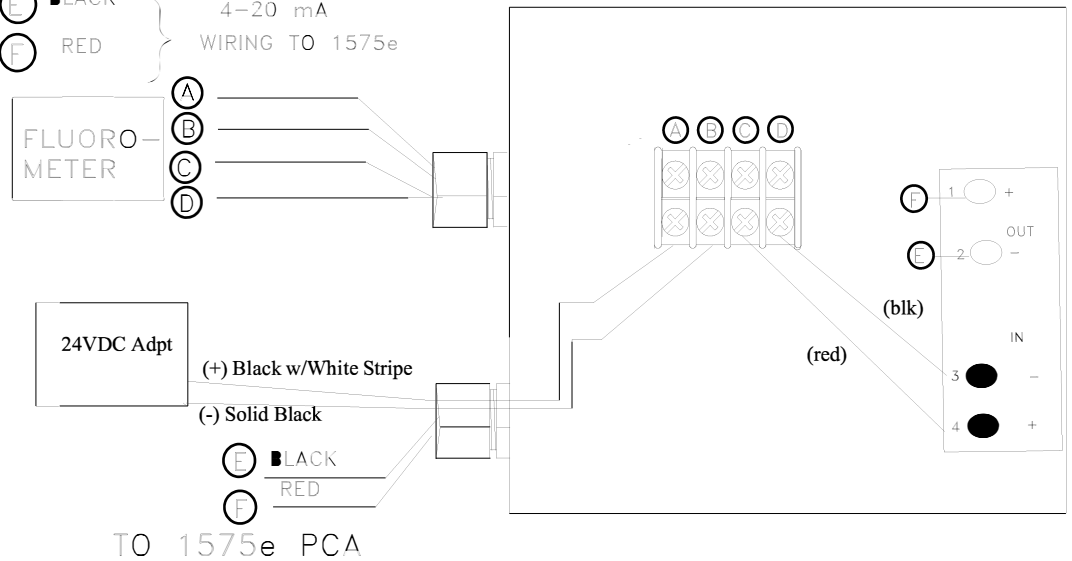

TO 1575e PCA

| REVISION | | REVISION HISTORY | | | |
|----------|------|------------------|-----|-------------|-----------|
| DWG | PART | DESCRIPTION | ECO | DWN DATE | APVD/DATE |
| A | | RELEASE | | PSG 10/2/12 | |

| | | |
|-----|-----------------|-----------|
| P13 | REF | |
| | SOLUTION GROUND | |
| | GND | |
| | pH TC+ | |
| | GND | |
| P8 | TC+ | |
| | I- | |
| | I+ | |
| | 4-20 mA | RED (F) |
| | PWR | |
| P2 | + OUT | |
| | - OUT | BLACK (E) |
| | GND | |
| | GND | |
| | METER 2 | |
| | +5V DC | |
| P7 | GND | |
| | METER 1 | |
| | +5V DC | |
| | GND | |
| | FL OW | |
| P5 | GND | |
| | DIG IN 2 | |
| | GND | |
| | DIG IN 1 | |

| | | | |
|--|-------------------------|--|-------------|
| <p>NOTICE ON REPRODUCTIONS</p> <p>THIS DRAWING, THE DESIGN AND THE PATENT'S IT COVERS, ARE THE PROPERTY OF LAKEWOOD INSTRUMENTS, LLC. THEY ARE LOANED MERELY AND ON THE BORROWERS EXPRESS AGREEMENT THAT THEY WILL NOT BE REPRODUCED, COPIED, LOANED, EXHIBITED NOR USED EXCEPT IN THE LIMITED WAY AND THE PRIVATE USE PERMITTED BY WRITTEN CONSENT GIVEN BY THE LENDER TO THE BORROWER</p> | | <p>Lakewood INSTRUMENTS</p> | |
| <p>DIMENSIONING AND TOLERANCING PER ASME Y14.5M-1994</p> | | <p>TITLE</p> <p>WIRING DIAGRAM FLUOROMETER SENSOR, M1575e</p> | |
| MATERIAL: | TOLERANCES UNLESS NOTED | SIZE | PN |
| | DECIMALS | C | 1229239 |
| | ANGLES | THRU ANGLE | |
| | X ± | | |
| | XX ± | | |
| | XXX ± | SCALE | DWG NO |
| FINISH | DWN PSG DATE 10-2-12 | SHEET | 1229239_11a |
| CHKD | DATE | | |
| PROJECT: | APVD DATE | | |
| LIBRARY: | | | |
| | | | REV |
| | | | A |
| | | | D |

For more information call toll free in the USA (800) 228-0839

Manufactured in the USA

Lakewood Instruments

7838 North Faulkner Road, Milwaukee, WI 53224 USA

Phone (800) 228-0839 • Fax (414) 355-3508

<http://www.lakewoodinstruments.com>