

Pyxis®

DW-2100P Series

Multi-Parameter Inline Analyzers for Drinking Water



Pyxis Lab® Inc.
21242 Spell Circle
Tomball, TX 77375
www.pyxis-lab.com

USER MANUAL

DW-2100P Series

Multi-Parameter Inline Analyzers for Drinking Water

User Manual

September 7, 2022
Rev. 1.11

Pyxis Lab, Inc.
21242 Spell Circle
Tomball TX, 77375
www.pyxis-lab.com

© 2017 Pyxis Lab, Inc.
Pyxis Lab Proprietary and Confidential

Confidentiality

The information contained in this manual may be confidential and proprietary and is the property of Pyxis Lab, Inc. Information disclosed herein shall not be used to manufacture, construct, or otherwise reproduce the goods described. Information disclosed herein shall not be disclosed to others or made public in any manner without the express written consent of Pyxis Lab, Inc.

Standard Limited Warranty

Pyxis Lab warrants its products for defects in materials and workmanship. Pyxis Lab will, at its option, repair or replace instrument components that prove to be defective with new or remanufactured components (i.e., equivalent to new). The warranty set forth is exclusive and no other warranty, whether written or oral, is expressed or implied.

Warranty Term

The Pyxis warranty term is thirteen (13) months ex-works. In no event shall the standard limited warranty coverage extend beyond thirteen (13) months from original shipment date.

Warranty Service

Damaged or dysfunctional instruments may be returned to Pyxis for repair or replacement. In some instances, replacement instruments may be available for short duration loan or lease.

Pyxis warrants that any labor services provided shall conform to the reasonable standards of technical competency and performance effective at the time of delivery. All service interventions are to be reviewed and authorized as correct and complete at the completion of the service by a customer representative, or designate. Pyxis warrants these services for 30 days after the authorization and will correct any qualifying deficiency in labor provided that the labor service deficiency is exactly related to the originating event. No other remedy, other than the provision of labor services, may be applicable.

Repair components (parts and materials), but not consumables, provided during a repair, or purchased individually, are warranted for 90 days ex-works for materials and workmanship. In no event will the incorporation of a warranted repair component into an instrument extend the whole instrument's warranty beyond its original term.

Warranty Shipping

A Repair Authorization (RA) Number must be obtained from Pyxis Technical Support before any product can be returned to the factory. Pyxis will pay freight charges to ship replacement or repaired products to the customer. The customer shall pay freight charges for returning products to Pyxis. Any product returned to the factory without an RA number will be returned to the customer. To receive an RMA you can generate a request on our website at <https://pyxis-lab.com/request-tech-support/>.

Pyxis Technical Support

Contact Pyxis Technical Support at +1 (866) 203-8397, service@pyxis-lab.com, or by filling out a request for support at <https://pyxis-lab.com/request-tech-support/>.

Related Statements

Safety Information

Please read this manual completely before unpacking, installing, and operating this equipment. In particular, pay attention to all dangers, warnings and precautions, otherwise, it may cause serious personal injury to the operator or damage to the equipment.

Use of Danger Information

 Danger
Indicates a potentially or urgent dangerous situation that, if not avoided, will cause death or serious injury.

 Warning
Indicates a potentially or very dangerous situation that, if not avoided, may cause serious personal injury or death.

 Warning
Indicates a potentially dangerous situation that may cause a certain degree of personal injury.

Attention
Indicates conditions that if not avoided, will cause damage to the instrument. This is information that needs special emphasis.

Warning Label

Please read all labels and marks attached to the instrument. Failure to follow the instructions on these safety labels may result in personal injury or damage to the instrument.





	If this symbol appears in the instrument, it means refer to the operation and/or safety information in the instruction manual.
	If there is this mark on the instrument housing or insulator, it means there is a risk of electric shock or death from electric shock.
	Static electricity can damage the delicate internal electronic components, resulting in reduced performance or eventual failure of the instrument.
	Electrical equipment marked with this symbol cannot be disposed of through the European public waste system after August 12, 2005. In order to comply with European regional and national regulations (EU Directive 2002 / 98 / EC), European electrical equipment users must now return abandoned or expired equipment to the manufacturer for disposal without any cost.

Table of Contents

Confidentiality	3
Standard Limited Warranty.....	3
Warranty Term.....	3
Warranty Service	3
Warranty Shipping.....	3
Pyxis Technical Support.....	3
1. Specifications.....	6
2. Unpackaging	7
3. System Layout and Features	7
4. Dimension and Mounting.....	9
5. Installation	11
5.1. Installation Requirements	11
5.2. Tube connection	11
5.3. Terminal Wiring.....	13
6. Touch Screen Operation	15
6.1. Main Screen.....	15
6.2. User Login.....	15
6.3. Real-Time Monitoring	16
6.4. Menu Bar.....	17
6.5. Configurable Parameters	18
6.5.1. Cleaning Parameters Setting - Using FRP-200 Optional Automatic Cleaning Module.....	18
6.5.2. Alarm Parameters Setting	19
6.5.3. Diagnostic Parameters.....	20
6.5.4. 4-20mA Output Parameters Setting	21
6.5.5. Communication Setting.....	21
6.6. Calibration.....	22
6.6.1. pH Calibration.....	22
6.6.2. Residual Chlorine Calibration.....	24
6.6.3. Turbidity Calibration	27
6.7. Recovering Data.....	32
6.8. Alarm View.....	32
6.9. Historical Data	33
6.10. Historical Data Curves.....	35
6.11. User Management	38
7. Daily Maintenance	40
7.1. Correspondence Address	40
7.2. Operation and Maintenance.....	41
7.3. Instrument Alarms and Descriptions.....	42
8. Replacing pH and Oxidizer Electrode Head	43
9. Updating Date, Time and firmware.....	44
9.1. Setting Time and Date.....	44
9.2. Firmware Update Procedure.....	46
10. Order Information.....	49

Specifications

Item	DW-2100P-US	DW-2100P-EU	DW-2100P-US-G	DW-2100P-EU-G
P/N	42135	42136	42137	42138
Turbidity Wavelength	Warm White	860 nm	Warm White	860 nm
Light Source	LED			
Turbidity Dual Range	0.001 – 10 / 10 - 40.00 NTU			
Turbidity Accuracy	+ 0.005 NTU or 2% <10NTU			
Turbidity Repeatability	+ 0.001 NTU or 0.5% <10NTU			
Free Chlorine Method	Bare Gold - Electrochemical Method			
Free Chlorine Range	0.01 –5.00 ppm as FCl ₂			
Selectivity	Non-Selective, cross sensitivity to other oxidizing species			
pH Range	0.01 – 14.00 pH			
Measurement Accuracy	0.001NTU or ± 1% Full Scale ±0.01 ppm or 1% Full Scale w/pH compensation to 9.0 ±0.01 pH			
Minimum Resolution	0.001 NTU / 0.01 ppm FCl / 0.01 pH			
Response time	4s – Turbidity / T95≤60s – FCl / T95≤5s - pH			
Compliance	EPA-180.1/334.0	ISO-7027/7393	EPA-180.1/334.0	ISO-7027/7393
Measurement Interval	Continuous Measurement			
Display	7-inch LCD Color Industrial Capacitive Touch Screen			
Storage Capacity	Built-In 4GB of Ram for Storing up to 1-Million Data/Event Records			
Power Requirement	96-260VAC / 50-60 Hz; 10A Fuse; 200 W			
Output	2 x 4-20 mA / RS-485 Modbus - RTU / Modbus TCP			
Input	2 x 4-20 mA / RS-485 Modbus - RTU			
USB	1 x USB host, for data downloading and screen upgrade			
Internet	RJ-45 socket, Modbus-TCP			
Panel Operational Temperature	40 – 113°F (4-45 °C)			
Storage Temperature	Instrument: -4 – 131°F (-20 – 55°C) / Sensors 32 – 122°F (0 – 50°C)			
Sample Water Temperature	40 – 104°F (4-40°C)			
Sample Water Pressure	7.25 – 30 psi (0.05 – 0.2MPa)			
FR-200 Sample Water Flow Rate	1,200-1,800mL / Minute			
FR-200 Line Size	¼-inch Inlet / ⅜-inch Overflow / 20mm Outlet / ½-inch Drain			
Rating	IP-65 Panel-Display / IP-67 Sensors			
Regulation	CE / RoHS			
Relative Humidity	20% - 90% (No Condensation)			
Altitude	<6,561 feet (<2,000 Meter)			
Dimensions (HxWxD)	Panel (DW-2100P) 790H x 450W x 235D mm			
Approximate Product Weight	DW-2100P ~ 20 kg			
Pyxis 4G CloudLink™	NA		Included	
CloudLink™ Bands	NA		Global B1/2/3/4/5/7/12/13/14/20/28/66/7	
CloudLink™ Protocols	NA		IP/TCP/UDP/HTTP/HTTPS/Modbus	

NOTE - Pyxis Lab is consistently updating technologies, as such, specifications may change without notice. Technical specifications on the LT-739/B and ST-765SS-FCL sensors can also be found in their respective Operation Manuals. Contact info@pyxis-lab.com for details or www.pyxis-lab.com.

Unpacking

The package includes the following items:

- One DW-2100P Drinking Water Panel Assembled and Complete with 110VAC Power Supply Cord
- 2.
- UC-100A Touch Screen Display/Data Logger with Pyxis Sensors Prewired in RS-485 (RTU)
 - FR-200 Dual Sensor Flow Reservoir
 - LT-739 (Warm White Light) or LT-739B (InfrRed) Ultra-Low Turbidity Sensor (as selected)
 - ST-765SS-FCL – Free Chlorine / pH / Temperature Sensor
 - Pyxis CloudLink™ – 4G Gateway (as selected models ending in “G”)

System Layout and Features

3. The DW-2100P series are multi-parameter inline water analyzers specifically designed as a ‘Turn-Key’ monitoring solution for clean water applications including drinking water networks, secondary water supply and decorative/swimming water applications. The DW-2100P series offers highly accurate, real-time measurement, display and data-logging of Ultra-Low Turbidity, Free Chlorine, pH and Temperature utilizing proprietary Pyxis Lab smart sensor technology, coupled with a Pyxis touch screen display and data logging terminal. The DW2100P series is offered in a convenient and easy to integrate panel mounted format for rapid installation and simple maintenance.

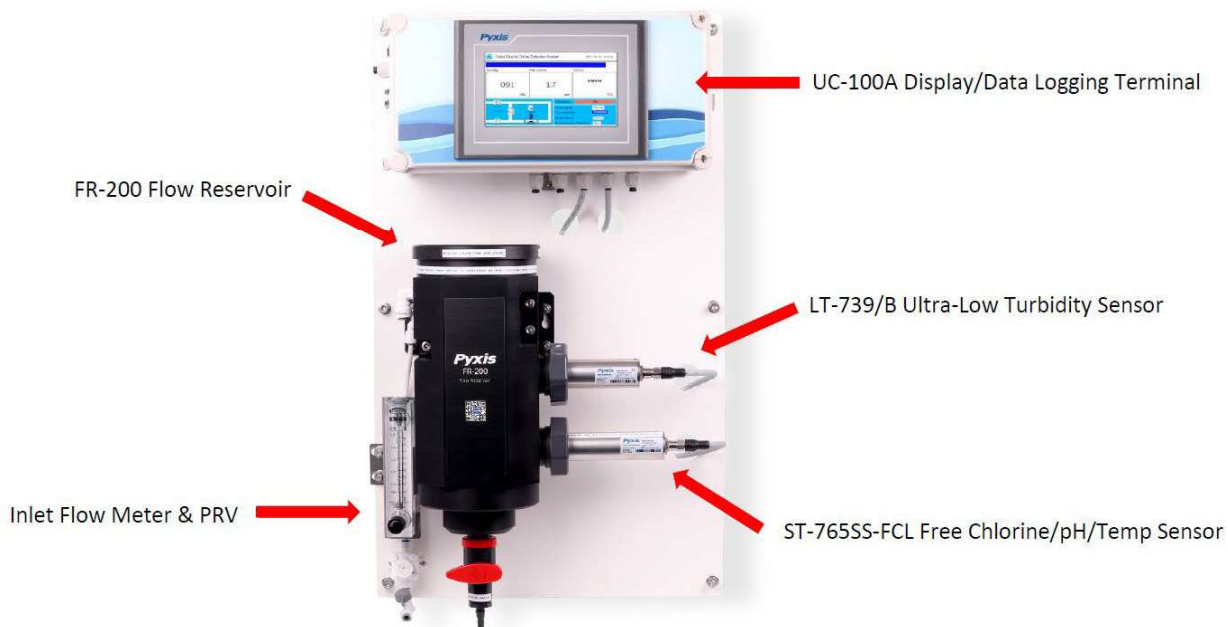

Figure 1 DW-2100P

DW-2100P Features

- Pyxis Lab's advanced research and development sensor technologies to achieve highly accurate and stable measurement of Turbidity, Free Chlorine, pH and Temperature.
- Pyxis LT-739 (EPA) and LT-739B (ISO) ultra-low resolution turbidity sensors offer a detection light source using warm white LED in 90-degree surface scatter format in accordance with USEPA 180.1 standards or Infra-Red 860nm in accordance with ISO-7027.1 standards. The turbidity sensors are mounted in the unique Pyxis FR-200 dual sensor flow reservoir enabling the highest resolution possible of 0.001NTU with unmatched stability. The LT-739 and LT-739 offers simple calibration with the L-CAL Portable Liquid Turbidity Calibration Kit (uses 500mL per calibration).
- Pyxis ST-765SS-FCL three-parameter composite sensor is used for the measurement residual free chlorine, pH and temperature in compliance with USEPA 334.0 and ISO-7393 guidelines. The sensors advanced PCB offers built-in temperature and pH parameter compensation (up to pH 9.0) algorithms eliminating the need for a supplemental pH sensor and controller. Unique Bare-Gold electrode technology for residual chlorine measurement eliminates membranes and electrode solution replenishment commonly associated with conventional sensors. The ST-765SS-FCL has a uniquely designed flat bubble pH electrode design for reduced fouling potential. Reduce your maintenance and cost versus colorimetric chlorine measurement or conventional electrochemical sensors by utilizing Pyxis replaceable Electrode Head (EH-765) for this sensor allowing for years of reliable service. The ST-765SS-FCL may be calibrated in-situ after cleaning via DPD Free Chlorine wet chemistry test measurement of active sample.
- Pyxis FR-200 Dual-Sensor flow reservoir provides sample calming for dissipation of air-bubbles and settling of suspended solids, foam or other impurities commonly observed in drinking water influent with a recommended flow range of 1,200-1,800mL/minute. This unique flow reservoir design results in the highest level of turbidity resolution on the market and greatly extends the maintenance cycle of the sensor while providing a large buffer capacity to mitigate pressure fluctuations. The minimum inlet pressure of FR-200 flow reservoir is only 7.5 psi (0.05mpa) making it highly suitable for the end of pipe networks and secondary supply influent sampling.
- Both sensors offer a self-cleaning flat electrode design making them easy to maintain and clean.
- Simple sensor removal and replacement. Both sensors are connected to the display/data logger via RS-485 Modbus (RTU) allowing for integrated sensor calibration interface and diagnostics within the display touch screen.
- Convenient and simple to install Back-Panel (DW-2100P) for rapid and easy installation. Truly a plumb and power to go platform with intense factory setup, testing and sensor calibration prior to shipment.
- Touch screen display/data logger interface with sensor calibration integrated. Display/data logger offers 2x 4-20mA I/O as well as RS-485 and TCP-IP with remote diagnosis and parameter adjustment. Pyxis CloudLink™ 4G Gateway version available.

Dimension and Mounting

DW-2100P Series Panel Dimensions (mm)

4.

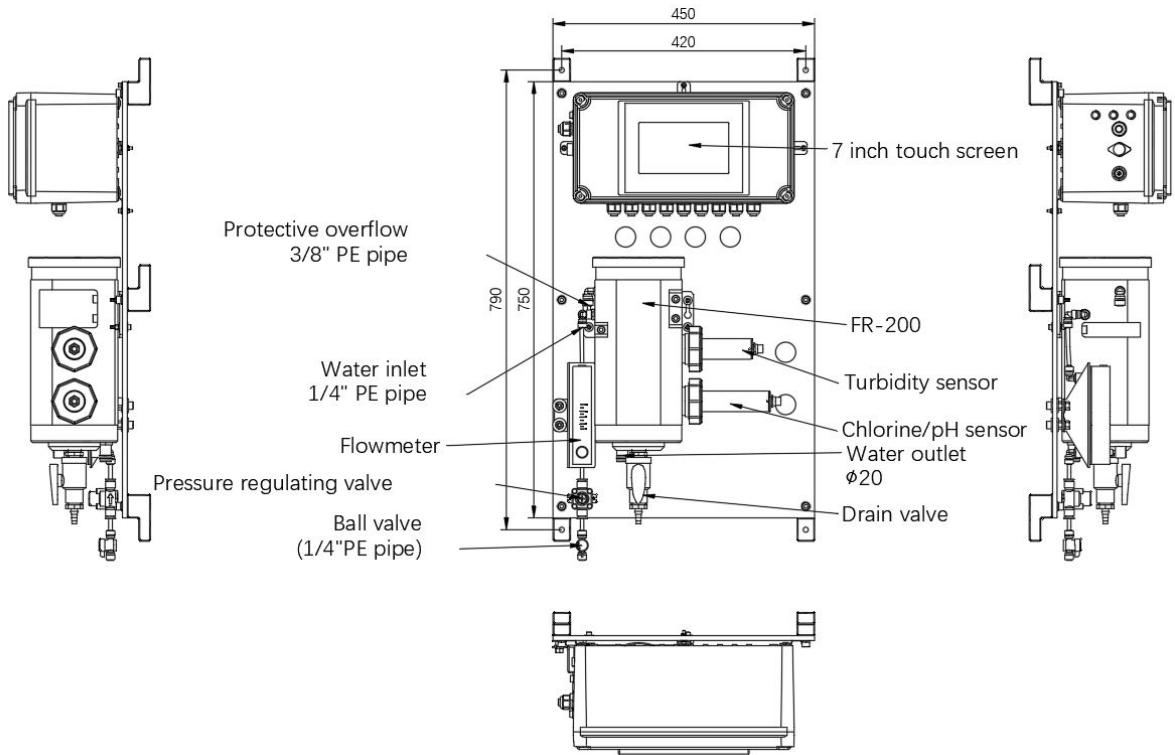

DW-2100P Series UC-100A Controller Dimensions (mm)

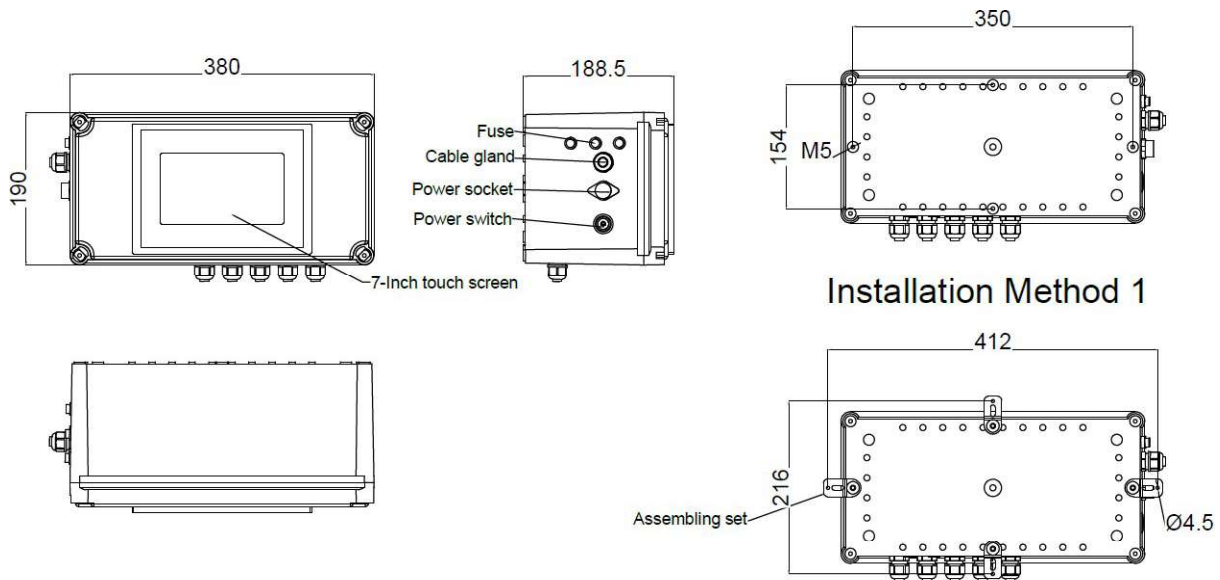

DW-2100P Series FR-200 Flow Reservoir Dimensions (mm)

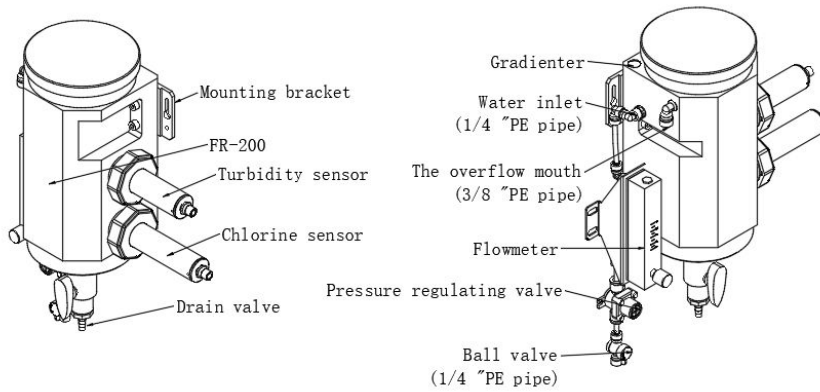
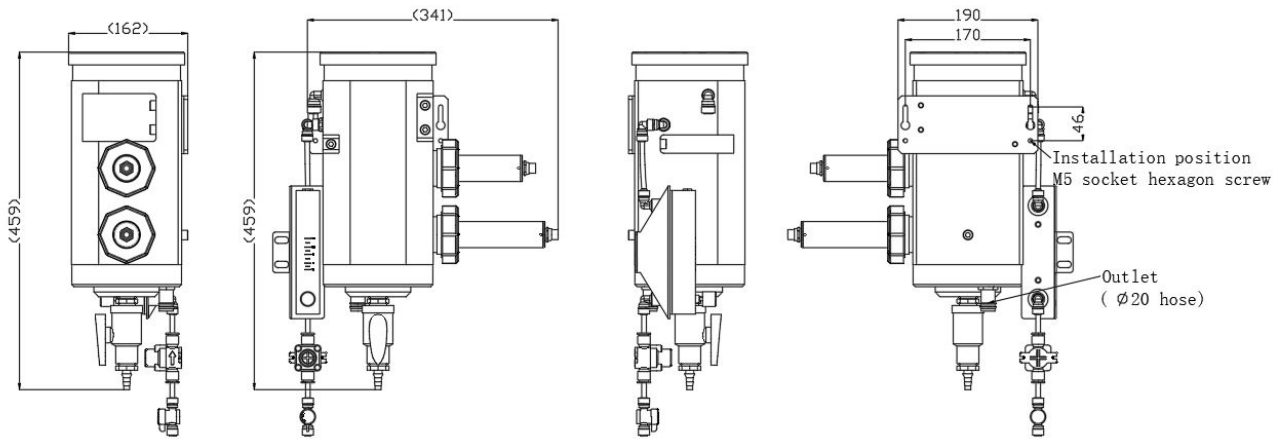

DW2100P Series Sensor Dimensions (mm)

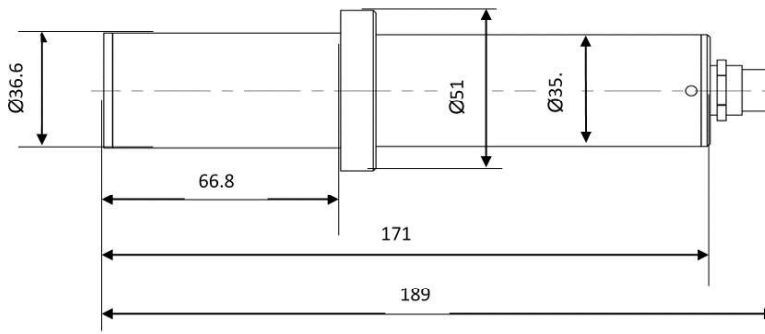

LT-739 / LT-739B Turbidity Sensor

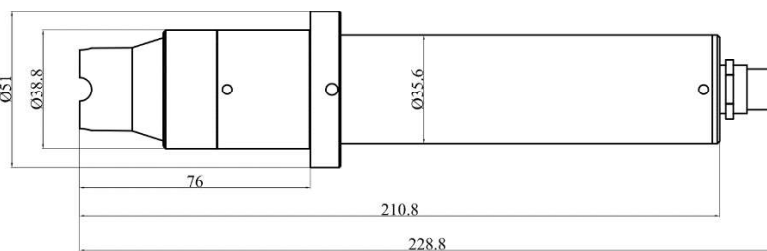

ST-765SS-FCL Free Chlorine + pH Sensor

5 Installation

5.1. Installation Requirements

Power Supply: 100~240VAC 50/60Hz

Water Supply: Inlet water pressure should be from 7.25 – 30 psi (0.05-0.2MPa) with an inlet feedwater line diameter of ¼-inch O.D. Tubing. The DW-2100P is provided with an inlet Rotameter and PRV for sample water inlet flow control and limited pressure regulation. Depending on sample water quality, these items may be installed on the application needs and user desire. The range of inlet flow for the FR-200 should be consistently maintained between 1,200-1,800 mL per minute.

Drainage: The FR-200 outlet tube (20mm Tubing) located on the bottom of the FR-200, as well as the FR-200 weir overflow (3/8-inch O.D. Tubing) located on the top of the FR-200, should both be connected to a discharge drain via gravity flow.

Wall Mount Space: The DW-2100P analyzer panel size is roughly 790H x 450W x 235D (mm) in dimension. Please accommodate sufficient space for mounting.

Wall Mount Weight: Approximately 20kg. Please use appropriate mounting hardware.

3G/4G Network: Make sure your mobile network is a CMCC/CUCC 3G/4G compatible network. Ensure the signal strength is sufficient in the installation area.

5.2. Tube connection

- Inlet Water:** Connect the ¼-inch inlet water tubing to the quick adapter provided. ****NOTE*** The inlet flow meter is shipped as a loose item and may be installed as desired by the user. If feedwater water quality is poor, users may desire to not install this flow meter. Consistent flow of 1,200-1,800mL is required.*
- Weir Overflow:** Connect the ¾-inch weir overflow tubing to the quick adapter provided. This line must be diverted to drain.
- Outlet Line:** Connect 20mm tubing to the outlet drain. This is the sample water outlet flow. This line must be diverted to drain.

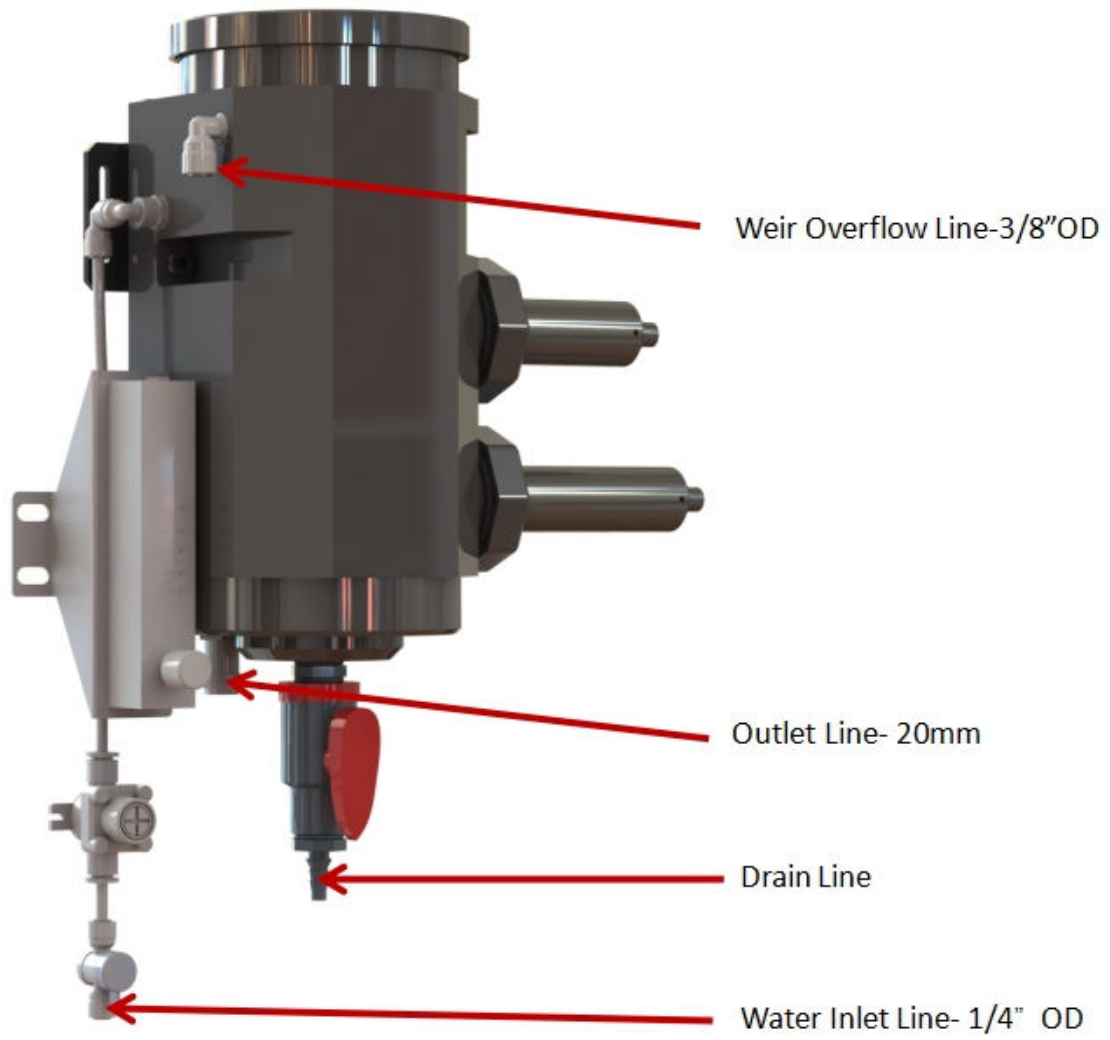

Figure 2 FR-200 Connections

5.3. Terminal Wiring

The DW-2100P analyzer has universal AC power supply equipment allowing users simply to plug the power supply into a 100~240V AC 50/60Hz power outlet for normal operation.

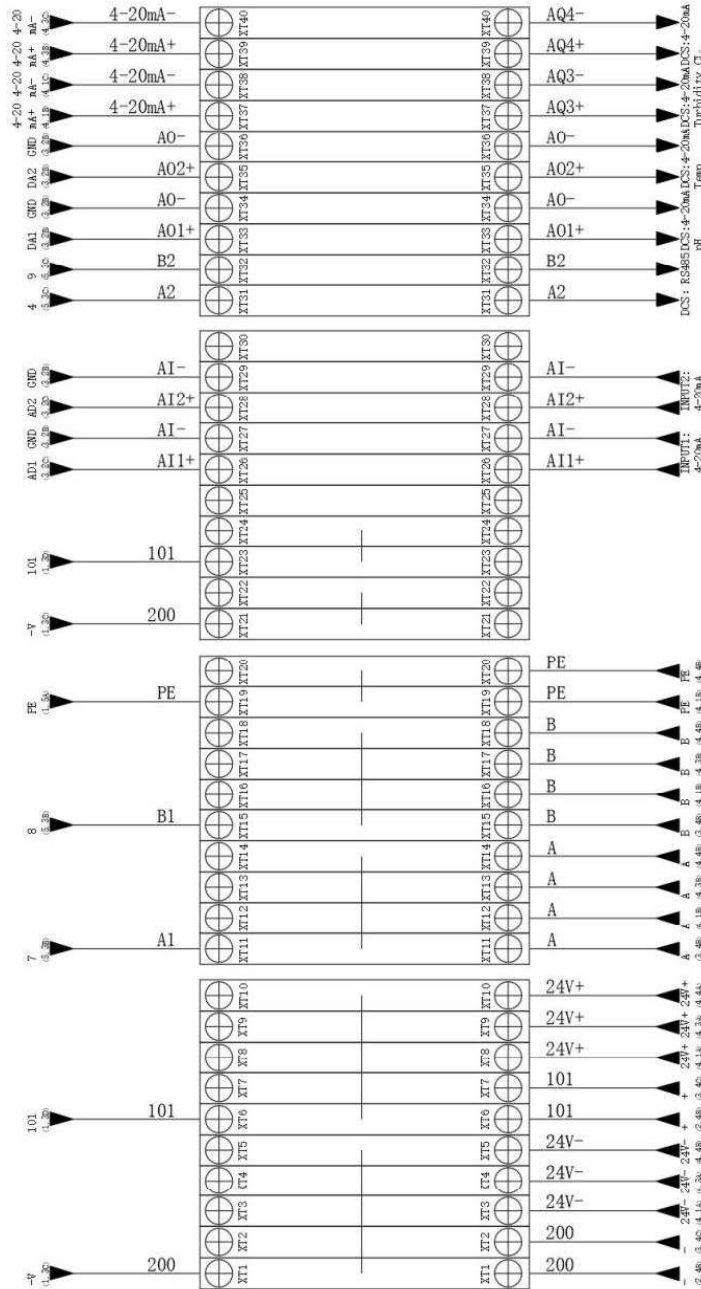

Figure 3 Terminal Wiring Diagram

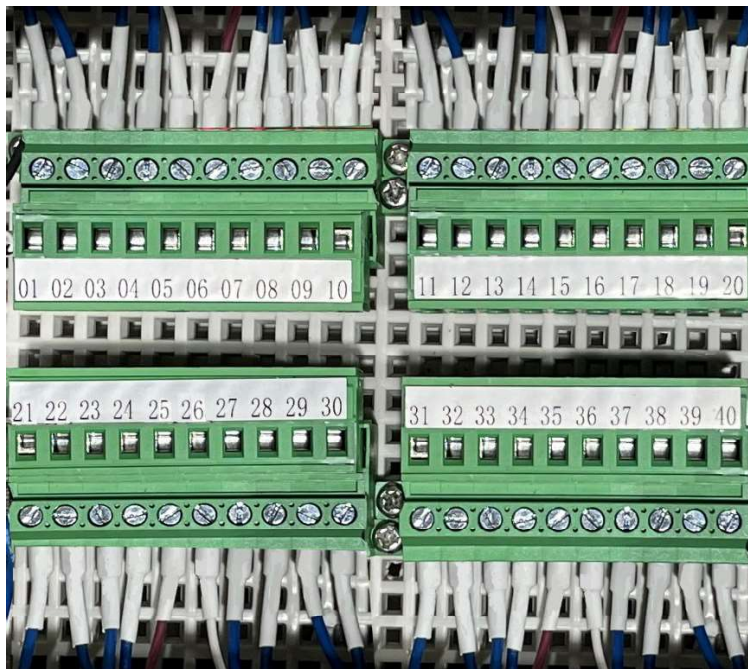

Figure 4 Terminal Physical Diagram

Warning

The process of electrical connection to contact the 220V single-phase power supply, should be operated by personnel with an electrician's license. Failure to operate according to the electrical code of practice may result in electric shock injury or even death.

Touch Screen Operation

6.1. Main Screen

After the system is powered on an initial screen allows the user to log into the system.



Figure 4 Main Screen

6.2. User Login

After powering on the system, log in with the username and password to be able to change system settings. Click the "User Login" button, select the user "**pyxis**", enter the password: "**888888**" in the user password field. A new user can be added via "User Management" in interface of the menu.

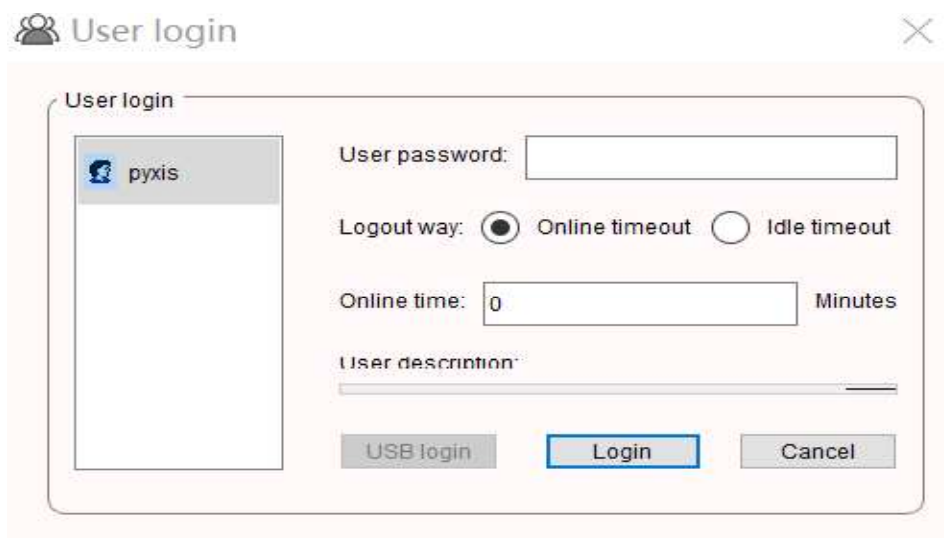

Figure 5 User Login Screen

If you do not need a password, or want to change the user, you can enter the system and "Manage" in the "User Management" screen of the menu. See 6.11 for details.

6.3. Real-Time Monitoring

Click the "Enter System" button on the main interface to enter the real-time monitoring screen of the system. The data detected by the Pyxis sensors will be displayed in real-time. See a functional overview of each section of this screen highlighted below. (numbers 1-4)

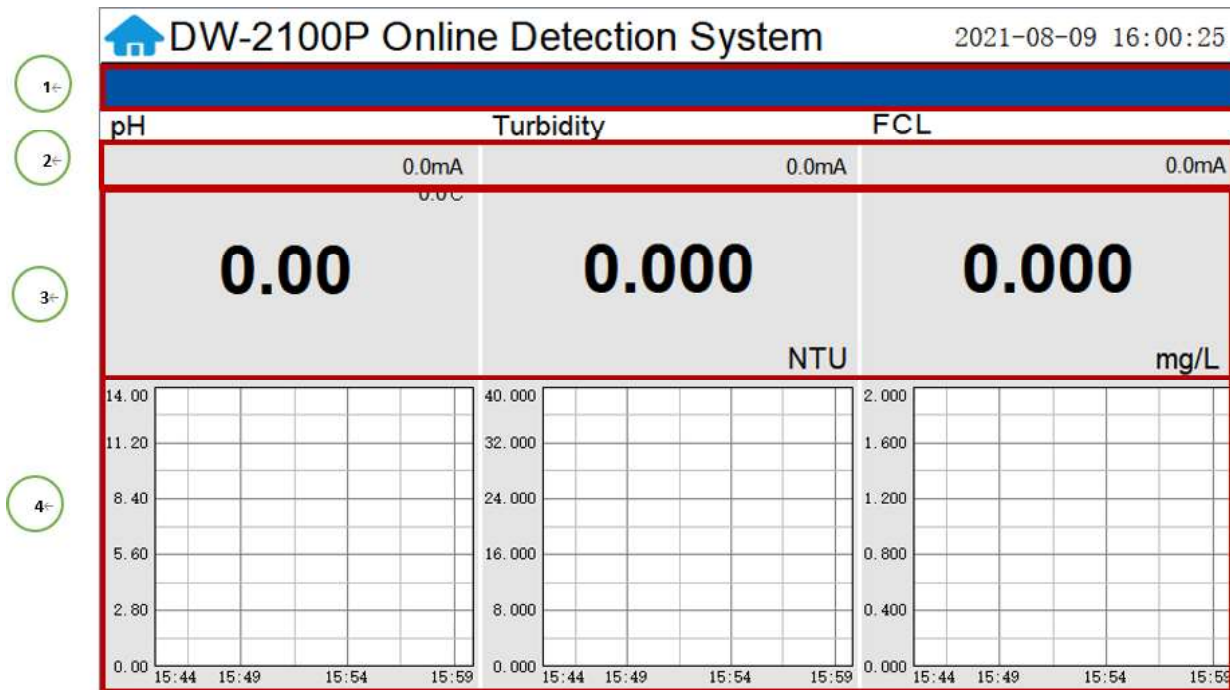

Figure 6 Real-time monitoring screen

Section Number	Functional Overview
1	The blue area will scroll any alarm information in real time until the alarm is cleared.
2	Real-time display of the current sensor's 4-20mA signal value.
3	Real-time display of current sensor measurement value.
4	Historical data is recorded as a live curve, with the horizontal coordinate being the time and the vertical coordinate being the measured value.

Table 1 - Main interface functional overview

Press and hold the curve area for 2 seconds and then let go, the Y-axis curve range setting dialog box will appear. Users may change the display value range of Y-axis for each measurement index curve. Click the outer area of the screen to save and exit the setting screen after modifications are made.

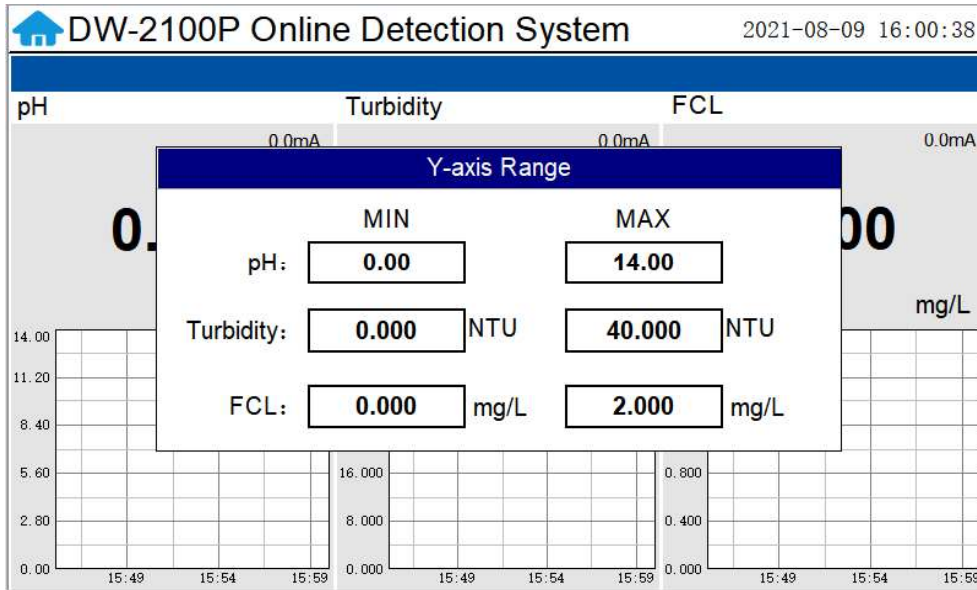



Figure 7 Curve Range Setting

6.4. Menu Bar

Click the  button in the upper left corner of the screen to enter the system's menu interface, where the user can select to enter the desired operation interface.

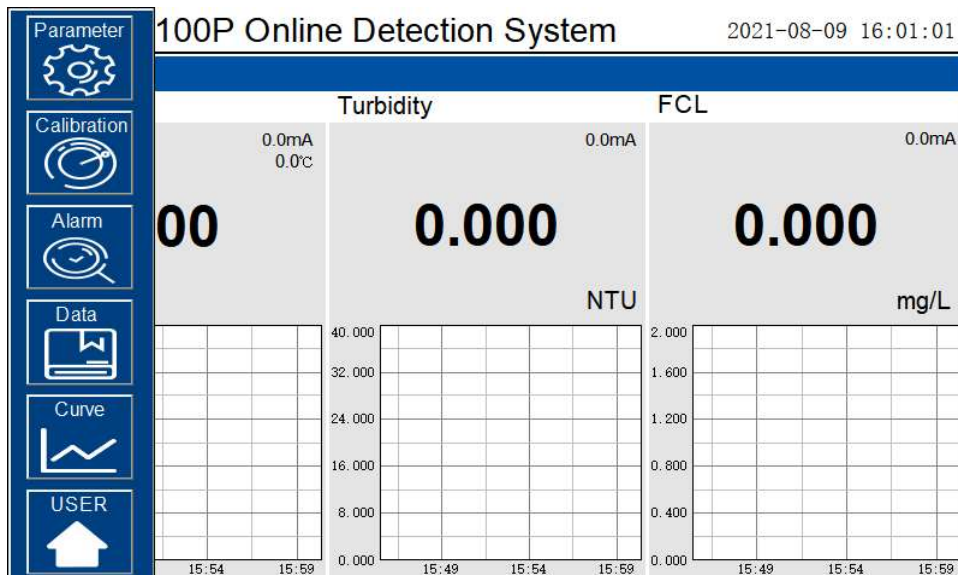

Figure 8 Menu Bar

6.5. Configurable Parameters

Click the "Parameter" button in the menu bar. Here you can select to enter "Alarm Parameters" and "4-20mA Output" setting interface etc.

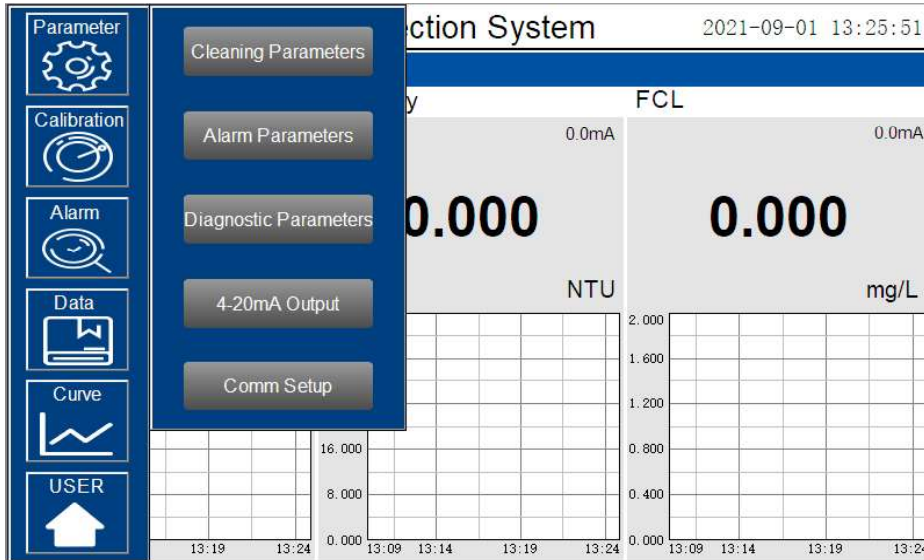

Figure 9 Parameter Settings

6.5.1. Cleaning Parameters Setting - Using FRP-200 Optional Automatic Cleaning Module

When entering the cleaning control parameter setting interface for the first time, a reminder screen will pop up. After confirming that the cleaning control module (FRP-200 optional accessory) is installed, click Enable to enter the parameter setting interface.

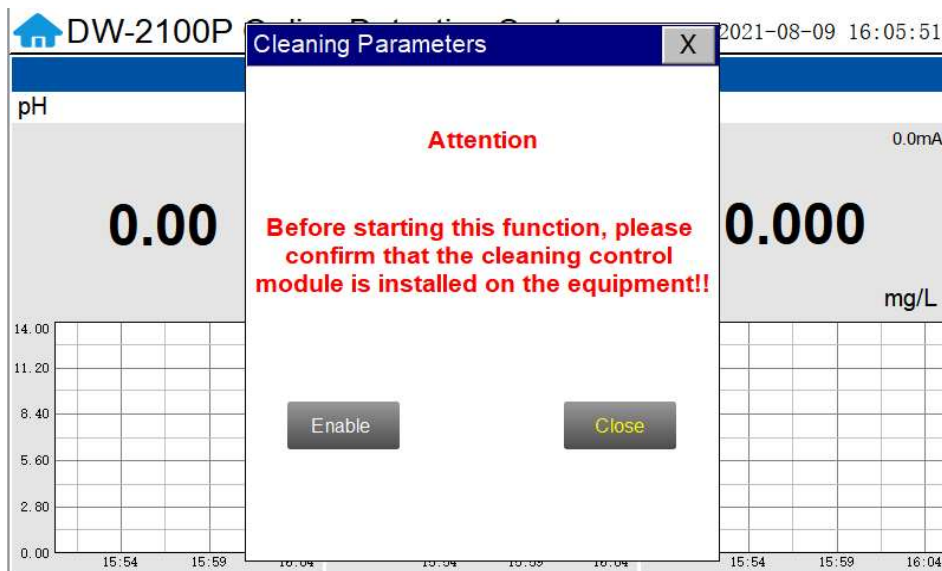

Figure 10 Cleaning module confirmation interface

On the parameter setting interface, you can set the automatic cleaning cycle time and cleaning frequency (FRP-200 brush rotation once is 1 time); Brush orientation and manual mode can also be set. Contact Pyxis Lab for details on purchasing the FRP-200 optional automatic cleaning module.

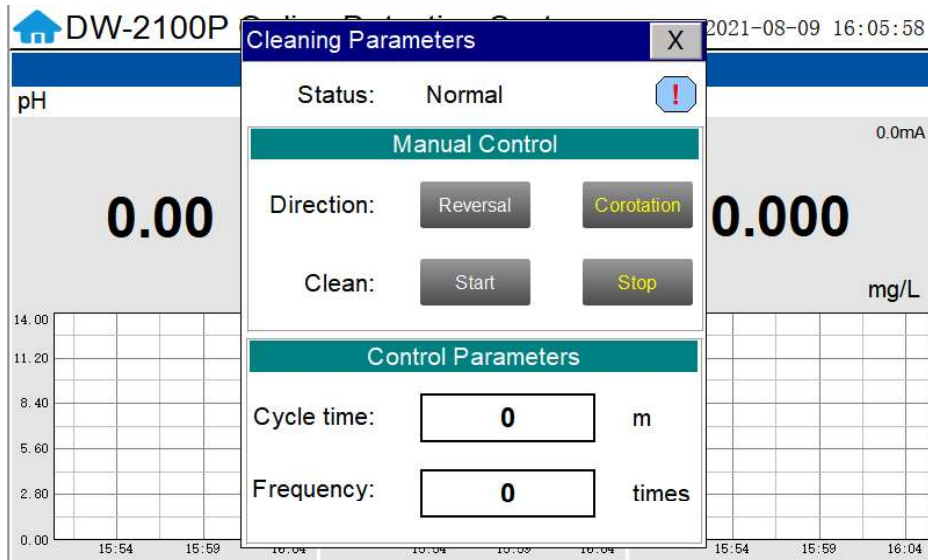

Figure 11 Automatic Cleaning Parameters Setting with Optional FRP-200 Module

6.5.2. Alarm Parameters Setting

Users can set the upper and lower alarm limits. Click "Alarm Parameters" to enter the alarm parameter settings. When the measured sensor value is lower than the set lower limit (the XX lower limit alarm) or when the measured value is higher than the set upper limit (the XX upper limit alarm), the corresponding sensor alarm will be displayed on the real-time monitoring screen. The user can also choose to turn the alarm display on or off at the top left of the corresponding parameter list.

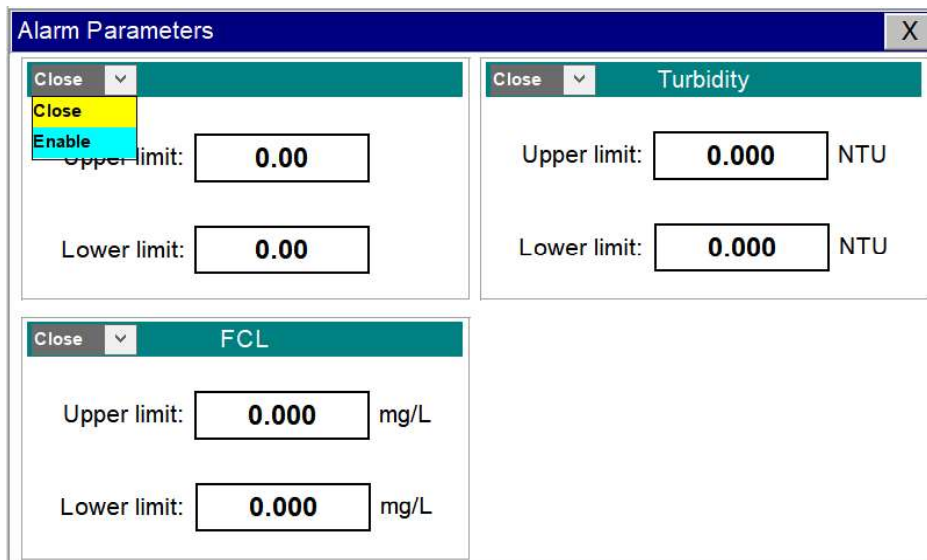

Figure 12 Alarm Parameter Setting

6.5.3. Diagnostic Parameters

Click “Diagnostic Parameters” to the diagnosis page. In the diagnosis page, the raw data measured by the sensor is displayed. To help troubleshooting possible issues with the sensor, please save an image of this data when the sensor is placed in a clean water sample (tap water or deionized water), in a standard, and in the sample that the sensor is intended for.



The screenshot shows a window titled "Diagnostic Parameters" with a close button (X) in the top right corner. The window is divided into two columns: "FCL" and "Turbidity".

FCL		Turbidity	
It_WorkCurrentnA:	0.000nA	s365DiLow:	0.000
pH_Voltage:	0.000V	s365DiHigh:	0.000
RTDValue:	0.000Ω	s365Low:	0
Offset:	0.000	s365High:	0
		intercept:	0.000
		SlopeLow:	0.000
		SlopeHigh:	0.000
		dark:	0
		t365:	0

Figure 13 Diagnostic Parameters

6.5.4. 4-20mA Output Parameters Setting

Click "4-20mA Output " to enter the 4-20mA output parameter setting interface. The 4mA and 20mA output values should corresponds to the lower and upper limits of the sensor range. ***NOTE*** *The closer the value is set to the measurement value the more accurate the data. It is recommended to set according to the range of the sensor.*

Parameter	4mA output	20mA output	Unit
pH	0.00	0.00	
Turbidity	0	0.000	NTU
Temp	0.0	0.0	°C
FCL	0	0.000	mg/L

Figure 14 4-20mA Output Setting

6.5.5. Communication Setting

DCS communication parameters generally do not need to be changed. If the DCS communication station number and other parameters need to be changed on site, they can be changed on this interface.

DW-2100P Online Detection System 2021-09-01 13:26:17

Modbus RTU

Address: 100

Baudrate: 9600

Databit: 8

Parity: Even Parity

Stopbit: 1

Read Write

Figure 15 Communication Parameters Setting

6.6. Calibration

Click on the "Calibration" button in the menu bar and select the sensor to be calibrated.

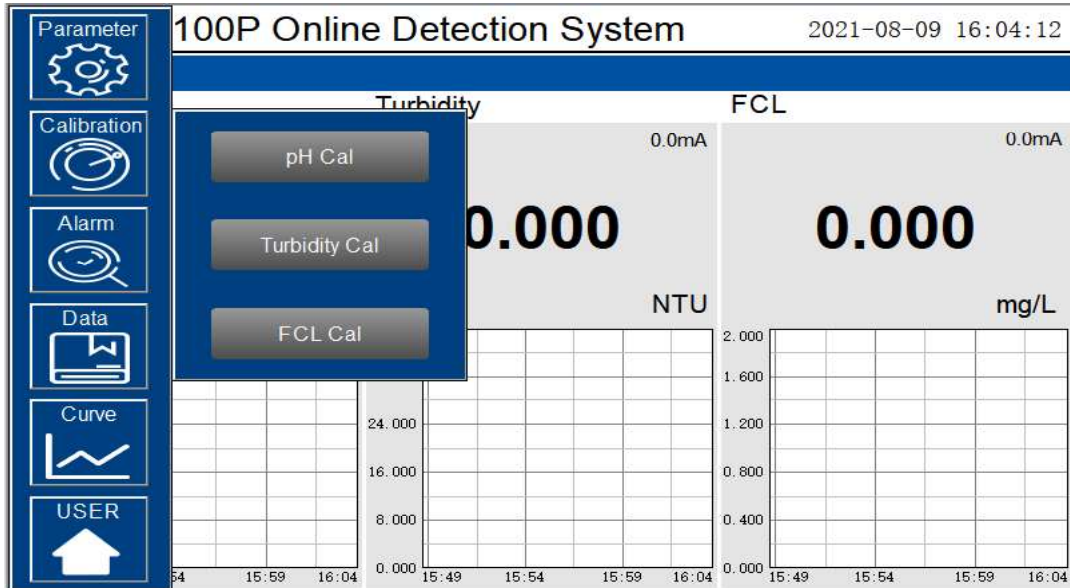

Figure 16 Sensor Calibration

6.6.1. pH Calibration

The pH function is thoroughly calibrated at the Pyxis Lab factory. After checking with a pH standard buffer solution, if the sensor value has shifted, then the user may choose from single-point, two-point or three-point calibration to re-calibrate the pH portion of the ST-765SS-FCL sensor as desired.

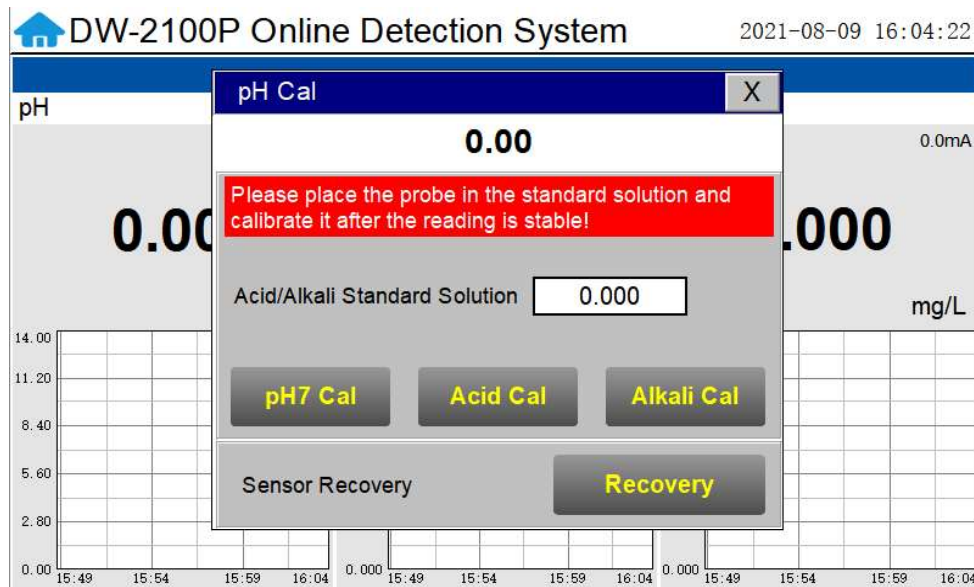

Figure 17 pH Calibration

Single Point pH Calibration

Remove the ST-765SS-FCL sensor and rinse 3x with DI water. Submerge the sensor into a beaker with pH=7 buffer solution. Click "pH7 calibration". A dialog box will pop up to confirm whether to perform this operation, click "OK" if the calibration operation is confirmed, if the calibration is successful the dialog box will show "calibration success".

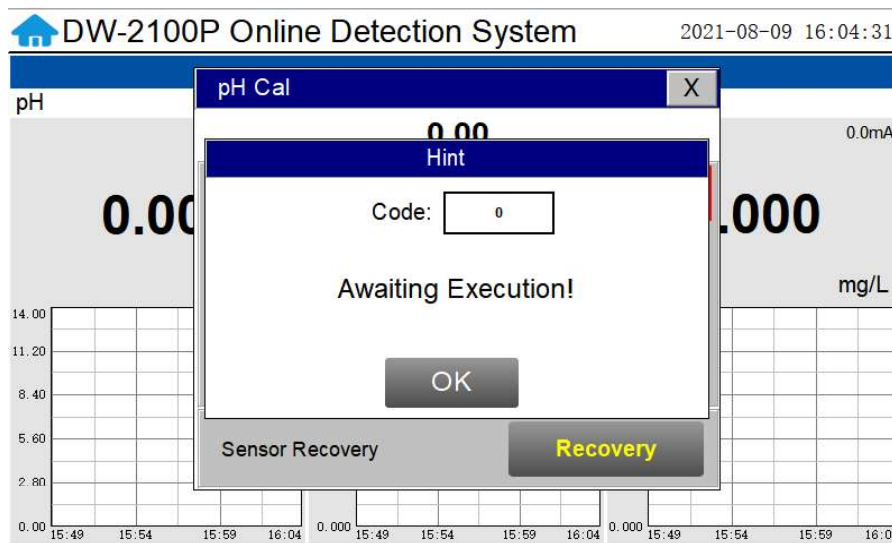

Figure 18 pH Calibration Success Prompt

Two Point pH Calibration

Remove the ST-765SS-FCL sensor and rinse 3x with DI water. Submerge the sensor into a beaker with pH=7 buffer solution. Click "pH7 calibration". A dialog box will pop up to confirm whether to perform this operation, click "OK" if the calibration operation is confirmed, if the calibration is successful the dialog box will show "calibration success".

After pH7 is successfully calibrated, you can choose acid calibration or alkali calibration for the second calibration point. If you choose acid calibration, clean beaker 3x with deionized water. Fill the beaker with pH=4 buffer solution. Enter the value 4 in the calibration value dialog box, and click "Acid Calibration", then a dialog box will pop up to confirm whether to perform this operation. Click "OK" if the calibration operation is confirmed and the dialog box will show "Calibration Successful" if the calibration is successful. Similarly a pH=10 buffer solution can be selected for the second point calibration if desired.

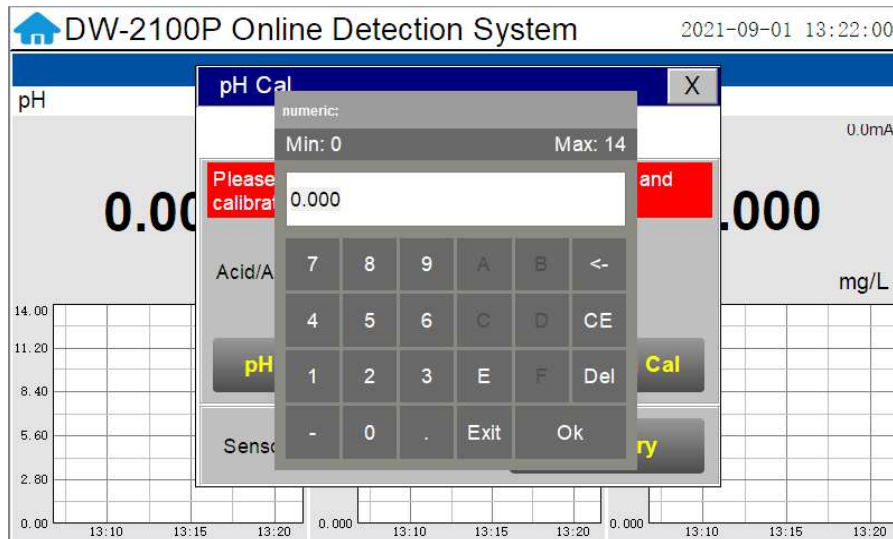

Figure 19 pH Calibration Value Input

Three Point pH Calibration

Remove the ST-765SS-FCL sensor and rinse 3x with DI water. Submerge the sensor into a beaker with pH=7 buffer solution. Click "pH7 calibration". A dialog box will pop up to confirm whether to perform this operation, click "OK" if the calibration operation is confirmed, if the calibration is successful the dialog box will show "calibration success".

After pH7 is successfully calibrated, you can choose acid calibration or alkali calibration for the second calibration point. If you choose acid calibration, clean the beaker 3x with deionized water. Fill the beaker with pH=4 buffer solution. Enter the value 4 in the calibration value dialog box, and click "Acid Calibration", then a dialog box will pop up to confirm whether to perform this operation. Click "OK" if the calibration operation is confirmed and the dialog box will show "Calibration Successful" if the calibration is successful.

After successful acid calibration, select pH=10 for alkali calibration. Clean the beaker 3x with deionized water. Fill the beaker with pH=10 buffer solution. Enter the value 10 in the calibration value dialog box, and click "Alkali Calibration", then a dialog box will pop up to confirm whether to perform this operation. Click "OK" if the calibration operation is confirmed and the dialog box will show "Calibration Successful" if the calibration is successful. The three-point calibration is completed.

6.6.2. Residual Chlorine Calibration

The residual chlorine measurement module of the ST-765SS-FCL sensor is thoroughly calibrated at the Pyxis Lab factory. To calibrate, the user can perform a single-point or two-point calibration according to the requirements of the application. (USEPA-334.0 / ISO-7393 compliant methodology)

Single Point Residual Chlorine Calibration

Use a portable or laboratory colorimeter to test the active (flowing) water sample in the FR-200 flow reservoir. DPD wet chemistry methodology is recommended. Once you have tested and confirmed the residual chlorine concentration value in the active (flowing) FR-200 flow reservoir, enter the test result value of the portable or laboratory colorimeter in FCL Calibration Screen and click "High Point Calibration". A dialog box will pop up to confirm whether to perform this operation. If the calibration operation is confirmed, click "OK", and if the calibration is successful, the dialog box will show "Calibration Success".

NOTE As an alternative, a standard residual chlorine solution (DPD residual chlorine standard is recommended) can also be used for calibration of the ST-765SS-FCL sensor while installed in the FR-200 flow reservoir. In order to calibrate the sensor with this approach, an external recirculation pump is required to ensure that the FR-200 flow reservoir is completely filled with the standard residual chlorine solution. A recirculation flow rate of 1,200-1,800ml/min is required for the ST-765SS-FCL to be properly calibrated using a known standard residual chlorine solution.

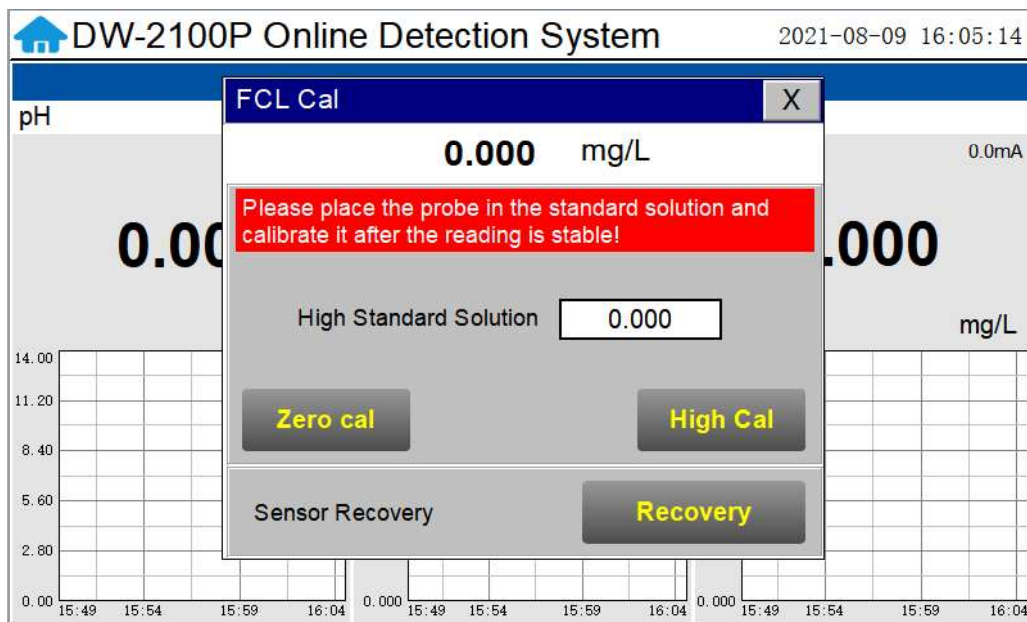

Figure 20 Residual Chlorine Calibration

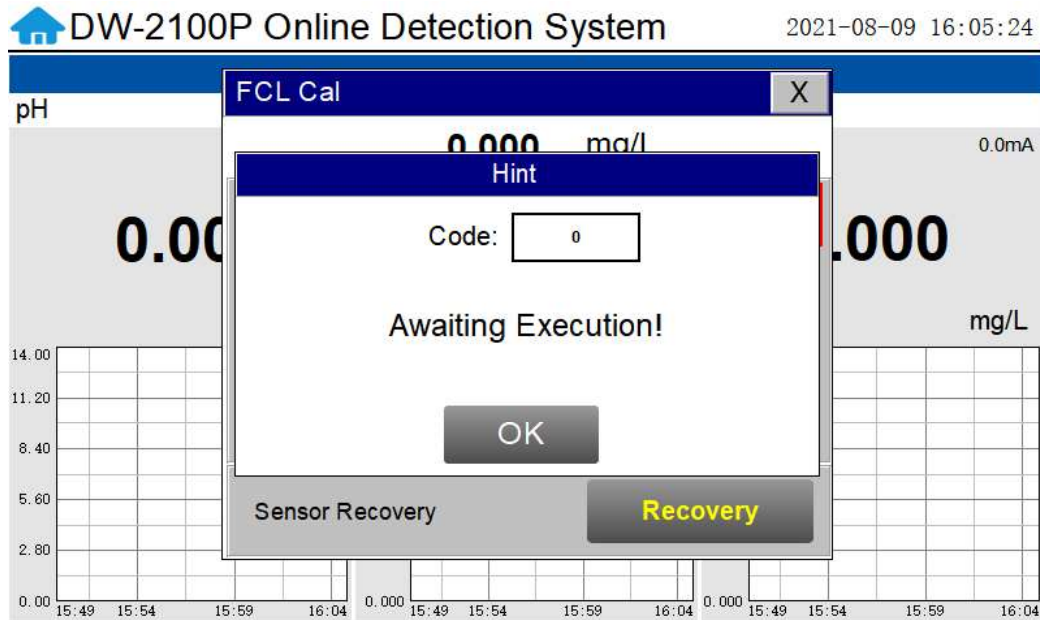

Figure 21 Awaiting execution Screen of Residual Chlorine Calibration

Two Point Residual Chlorine Calibration

The intercept in the ST-765SS-FCL sensor residual chlorine concentration formula is non-zero from the Pyxis Lab factory, however the user can make a blank calibration to correct the intercept in the residual chlorine concentration formula according to application needs.

Blank Calibration Procedure:

To achieve blank calibration of the ST-765SS-FCL sensor, close the water inlet valve and clean the FR-200 flow reservoir with deionized water 2-3 times. Then fill the FR-200 flow reservoir with the known zero calibration solution. After filling the FR-200 with zero calibration solution (PN:21022) or Conductivity Standard Solution (100 us/cm), wait for the ST-765SS-FCL sensor residual chlorine display value to stabilize on the touch-screen display. Sensor stabilization should occur within 15-minutes. Click "Zero Calibration" and a dialog box will pop up confirm whether your desire to perform this operation. Click "OK" to confirm the calibration operation. If the calibration is successful, the dialog box will show "Calibration Success". The sensor is now blank-calibrated to the known zero calibration solution.

Slope Calibration Procedure:

Use a portable or laboratory colorimeter to test the active (flowing) water sample in the FR-200 flow reservoir. DPD wet chemistry methodology is recommended. Once you have tested and confirmed the residual chlorine concentration value in the active (flowing) FR-200 flow reservoir, enter the test result value of the portable or laboratory colorimeter in FCL Calibration Screen and click "High Point Calibration". A dialog box will pop up to confirm whether to perform this operation. If the calibration operation is confirmed, click "OK", and if the calibration is successful, the dialog box will show "Calibration Success".

NOTE As an alternative, a standard residual chlorine solution (DPD residual chlorine standard is recommended) can also be used for calibration of the ST-765SS-FCL sensor while installed in the FR-200 flow reservoir. In order to calibrate the sensor with this approach, an external recirculation pump is required to ensure that the FR-200 flow reservoir is completely filled with the standard residual chlorine solution. A recirculation flow rate of 1,200-1,800ml/min is required for the ST-765SS-FCL to be properly calibrated using a known standard residual chlorine solution.

6.6.3. Turbidity Calibration

The LT-739 Ultra Low Turbidity Sensor is rigorously calibrated at the Pyxis Lab factory. If the sensor is kept clean, the user will not need to calibrate the sensor for one year of operation. However, the user may calibrate the sensor as desired.

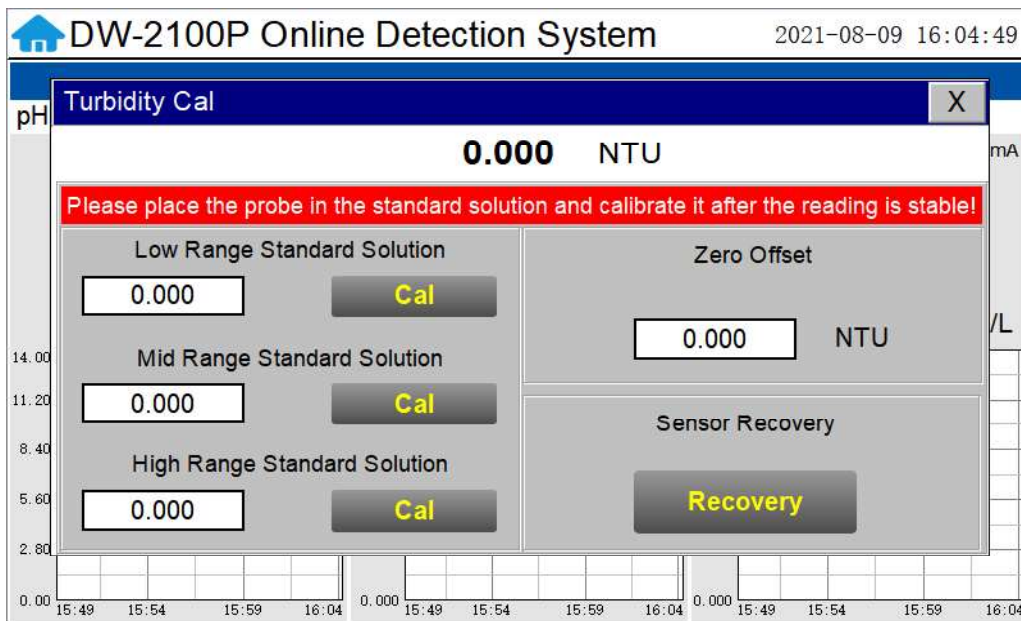

Figure 22 Turbidity Calibration Screen

Low-Range Calibration Procedure DI Water in the Pyxis L-CAL Portable Turbidity Calibration Kit:

Isolate the panel and drain the piping and inline Tee assemblies. Remove the LT-739 sensor from the FT-100 flow tee. Triple rinse the LT-739 sensor surface, the FR-200 flow reservoir internals and the L-CAL Portable Turbidity Calibration Kit (P/N 53247) vessel with Deionized water. Insert the cleaned LT-739 turbidity sensor into the L-CAL calibration vessel and position the L-CAL vessel vertically (with the sensor inserted in a horizontal position to the ground as shown in the step-by-step images provided on page 31 of this manual). Remove the top cap and fill the L-CAL vessel with 500mL of bubble free deionized water. After the displayed turbidity data is stable, enter "0.05" for the low-range calibration value and click on "Low Range Calibration", a dialog box will pop up to confirm whether to perform this operation. Click "OK", if the calibration is successful, the dialog box will show "Calibration successful". *NOTE* Because there is no global standard for zero turbidity in the industry, Pyxis recommends 0.05 NTU as a target for Low-Point Calibration while using Bubble-Free DI Water.

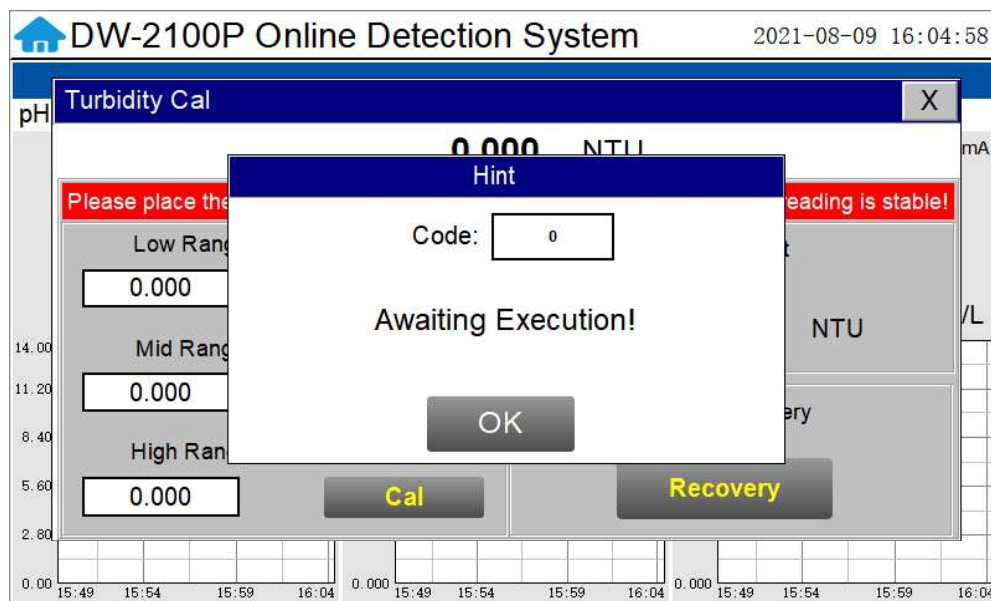

Figure 23 Awaiting execution Screen of Turbidity Calibration

Mid-Range Calibration using the L-CAL Portable Turbidity Calibration Kit:

After the low range calibration has been completed, rinse the L-CAL vessel with Deionized water and refill with 500mL of known turbidity standard solution between 5NTU and 10NTU for mid-range calibration (see page 31). After the displayed data is stable, enter the medium turbidity standard solution value and click on "Mid Range Calibration", a dialog box will pop up to confirm whether to perform this operation. Click "OK", if the calibration is successful, the dialog box will show "Calibration successful".

High-Range Calibration using the L-CAL Portable Turbidity Calibration Kit:

If a high-range calibration is not required, the user does not need to perform a high-range calibration of the LT-739 series sensor. If a high calibration is required, proceed by rinsing the L-CAL vessel with deionized water and refill with known turbidity standard solution between 20NTU and 40NTU for high-range calibration (see page 31). After the displayed data is stable, enter the high turbidity standard solution value and click on "High Range Calibration", a dialog box will pop up to confirm whether to perform this operation. Click "OK", if the calibration is successful, the dialog box will show "Calibration successful".

Troubleshooting Calibration Failed Messages

If you receive a “Calibration Fails” message during the calibration steps above, the following items should be checked:

- 1) Ensure your source of Deionized water is not contaminated with turbidity
- 2) Ensure your turbidity calibration standard solutions have not been contaminated
- 3) Ensure the LT-739 sensor distillate end is not contaminated with debris or other substances
- 4) Ensure the FR-200 flow reservoir is not contaminated or circulation blocked by debris or other materials.

LT-739 Calibration using L-CAL Portable Turbidity Calibration Kit

As an alternative to using the FR-200 flow reservoir for LT-739 sensor calibration, Pyxis Lab has developed a portable and reusable liquid-state turbidity calibration kit for rapid calibration of the all LT-73X Series inline ultra-low turbidity sensors. The L-CAL calibration kit allows users to calibrate all LT-73X Series ultra-low turbidity sensors using smaller volumes of Formazin turbidity calibration standards providing an affordable and reusable solution for long term sensor reliability. The unique design of the L-CAL liquid calibration kit allows the LT-73X sensor to be easily inserted and calibrated with the sensor in a horizontal position, allowing air bubbles to be evacuated through the integrated air-vent line ensuring superior accuracy of the sensor calibration. The L-CAL has an easy to remove lid allowing users to fill and empty the calibration kit with DI water for vessel/sensor cleaning and Formazin calibration standards for sensor calibration.



L-CAL Liquid Turbidity Calibration Kit (P/N 53247)

Turbidity Calibration Principals & Considerations

The precision, resolution and the low detection limit of the LT-73X Series sensors are not affected by the calibration method, regardless of using certified Formazin standards and the L-CAL kit. The calibration only affects the turbidity sensor accuracy. The nature of turbidity measurement makes an absolute turbidity value not easily obtainable for any sensor manufacturer although proper standards and methods are followed. For example, turbidity values greater than 1.0 NTU measured on real-world samples with different sensors, even from the single manufacturer, could differ significantly. For ultra-low turbidity (less than 0.3 NTU) measurement using the same methods (ISO-7027 or EPA-180.1), it is likely that the values from different sensors can agree within 0.05 NTU. As such, the user should choose a calibration method and remain with the same calibration method for consistency.

L-CAL Specifications

Item	L-CAL Portable Liquid Formazin Calibration Kit
P/N	53247
Sensor Name	LT-739 / LT-739B
Calibration	Recommended Calibration Standard Solution Range
Low-Range (0.05NTU Recommended for Calibration)	Bubble Free DI Water or Sample <0.1 NTU
Mid-Range	5 – 10 NTU
High-Range	20 – 40 NTU

L-CAL Portable Liquid Formazin Calibration Kit Use Method

After removing the LT-73X sensor, gently wipe off the flat distal end with a soft cloth to ensure it is clean. The LT-73X Sensor should then be calibrated using the L-CAL portable liquid calibration kit using the following steps, and wirelessly calibrated via the uPyxis Mobile or Desktop APP. Please refer to LT-73X Series Operation Manual for details.

Insert LT-73X Sensor



Tighten Sensor Nut



Position Vertically and Remove Lid



Preclean by adding DI-Water (200mL)



Insert Lid



Gently Shake Then Empty Contents



Add Calibration Standard (500mL)



Insert Lid and Remove Air Bubble Vent Line Cap



FOLLOW
CALIBRATION
STEPS

**NOTE* Sensor Brace Included with L-CAL Kit for Stability*



WATCH PROCEDURE VIDEO <https://www.youtube.com/watch?v=1MuJM5Q5VB4>

6.7. Recovering Data

Click the restore button in the calibration interface of each sensor to restore the data of pH/residual chlorine sensor and turbidity sensor. If a user error is made during calibration and other operations, you may restore the factory settings of the sensor through the restore function.

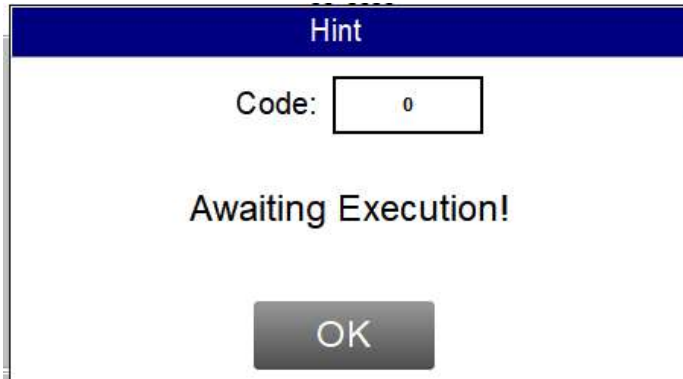

≡ *Figure 24 Data Recovery Success Screen*

6.8. Alarm View

Click the "Alarm View" button on the main screen to enter the alarm view screen.

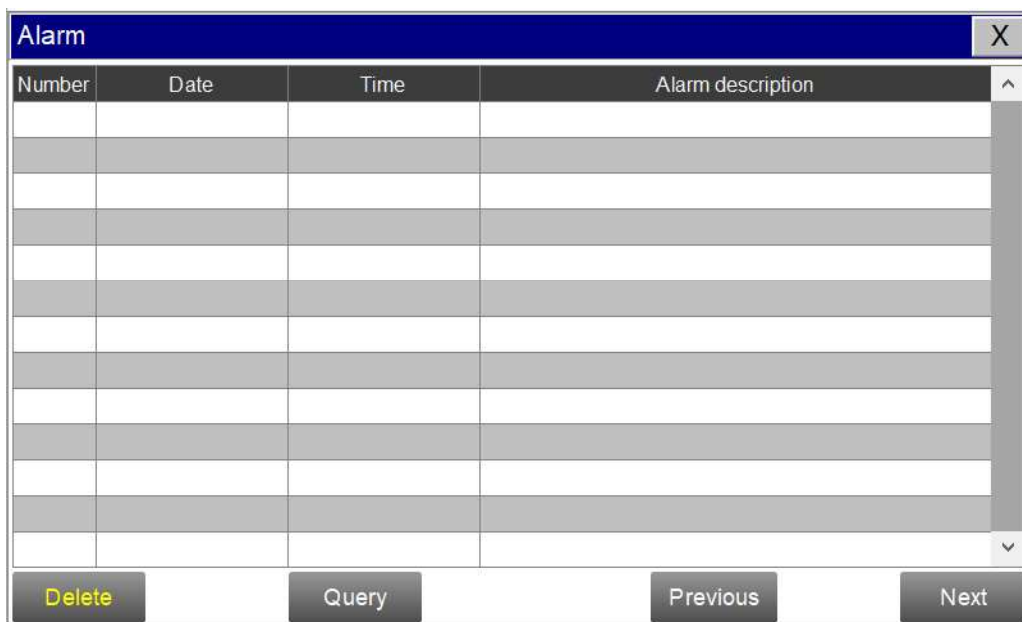

Figure 25 Alarm View

In this screen users can browse all logged alarms. Drag the right scroll bar up and down to view the history of alarms. Click "Previous" and "Next" to advance to the next page. Click "Query" then enter the alarm number in the pop-up box to query that alarm.

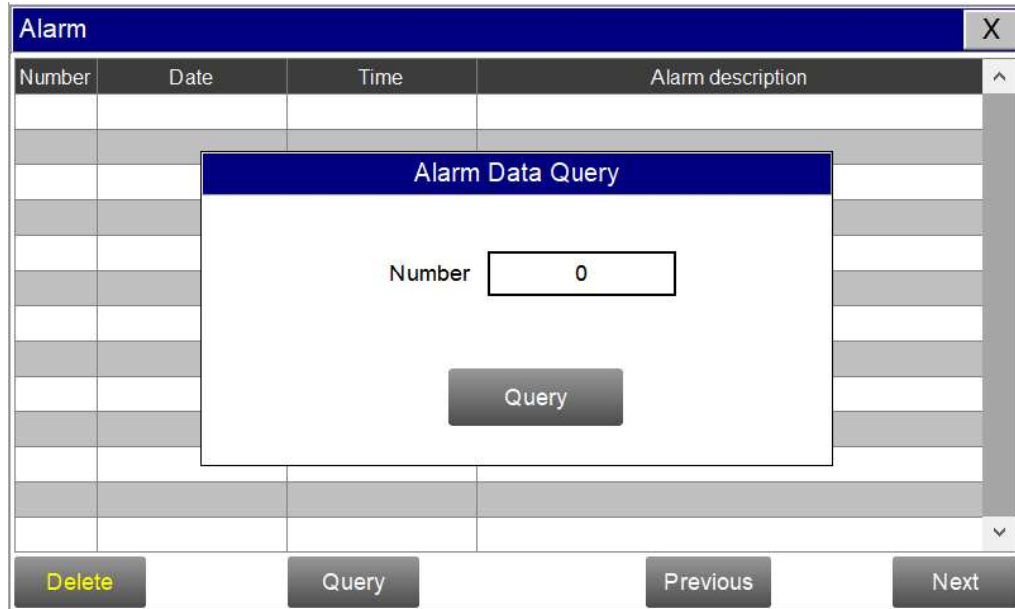

Figure 26 Alarm Data Query Screen

The Delete button in the lower left corner will delete all alarm records. After clicking delete, you must exit the screen and reenter before the historical data within the data report will be cleared.

6.9. Historical Data

Click the "Historical Data" button in the menu bar to enter the data report interface.

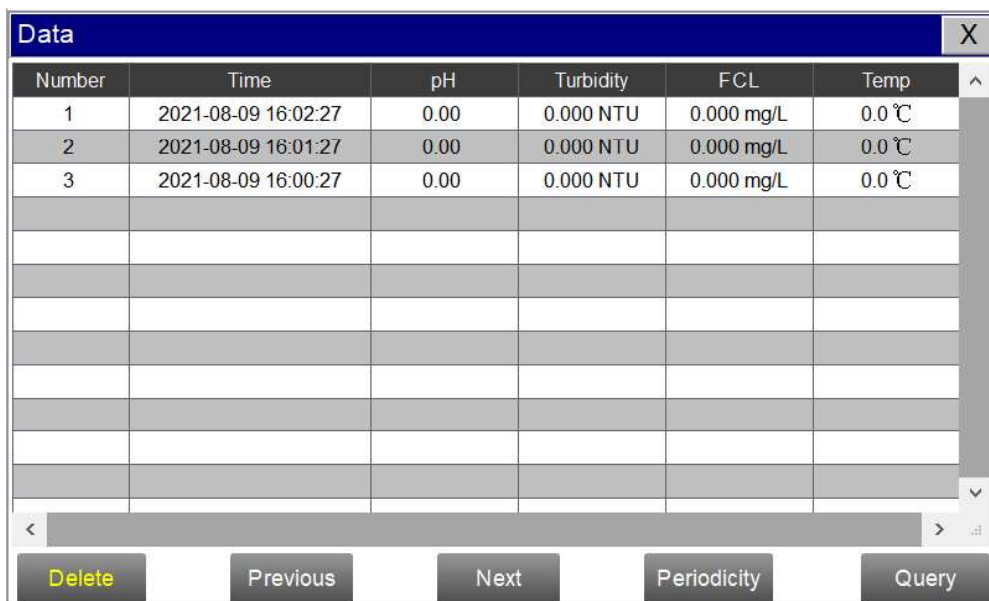

Figure 27 Historical Data Screen

In the data report, the user can view the stored data of all parameters. The system records sensor readings every 4 seconds by default but this can be edited by the user if desired. Drag the scroll bar on the right to slide up or down or click "Previous" and "Next" to view historical data records. The data record can save up to 100,000 data entries. New data will overwrite the previously saved data after recording 100,000 data entries. The user can click the "Periodicity" button to change the data recording time interval.

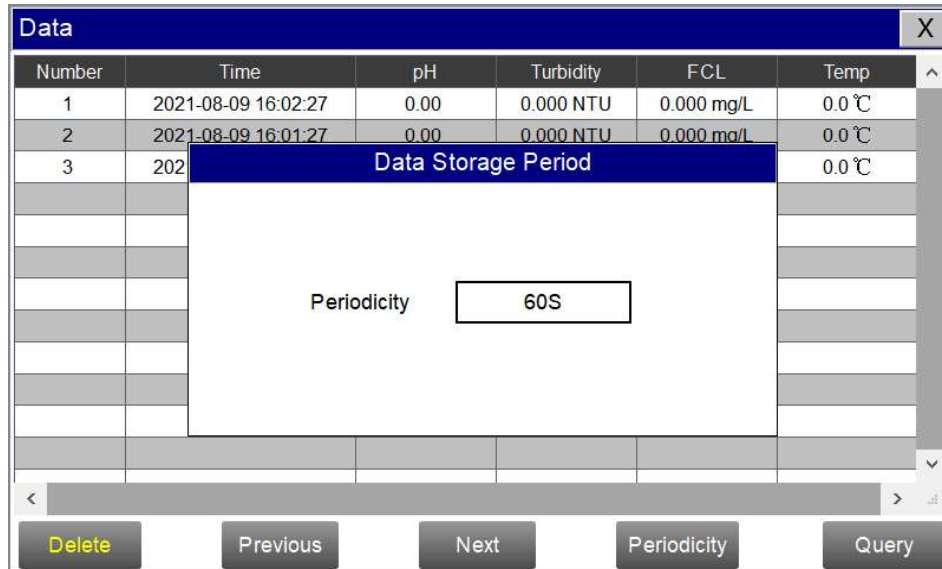

Figure 28 Data Storage Cycle Time Setting

Click "Delete" in the lower left corner. After entering the retention time, click the "Delete" button to clear all historical data within the retention time range.

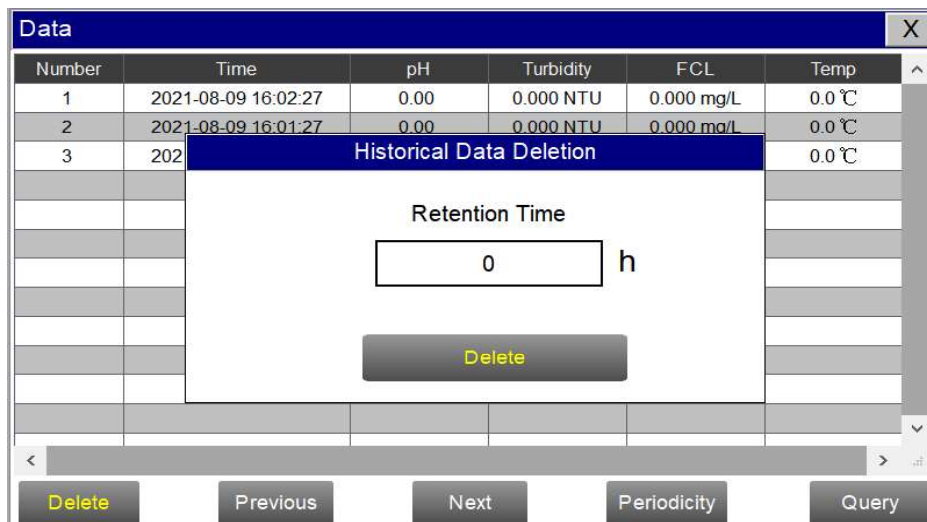

Figure 29 History Data Deletion Screen

Click the “Query” button in the lower right corner, enter the start time and end time and then click the “Query” button. Note that the start time and end time must be filled in exactly and completely according to the system time format.

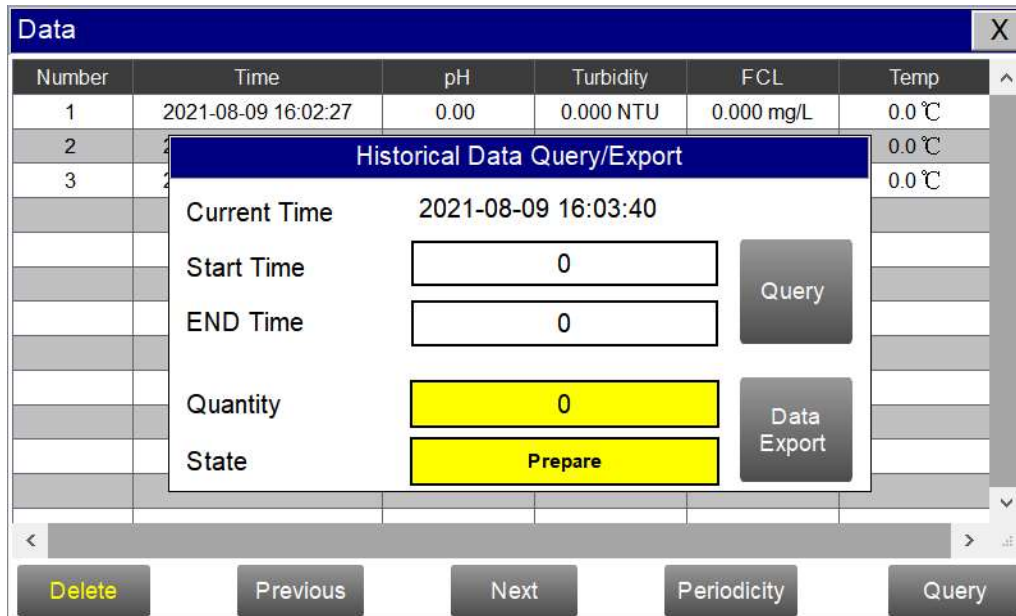

Figure 30 Historical Data Query and Export Screen

Insert a USB disk behind the display screen and enter the time range of the data to be exported in the query area. Click on the “Data Export” to download the data to the USB disk. The data quantity will be shown as a positive number if data export is successful. If the data export was not successful, please check whether the time format is correct.

6.10. Historical Data Curves

Click the "Historical Curve" button in the menu bar to enter the trend curve interface. You can click the buttons below the X-axis to browse and view the values in a different time range. Click on Y-axis Range to change the minimum and maximum Y-axis values for a proper range.

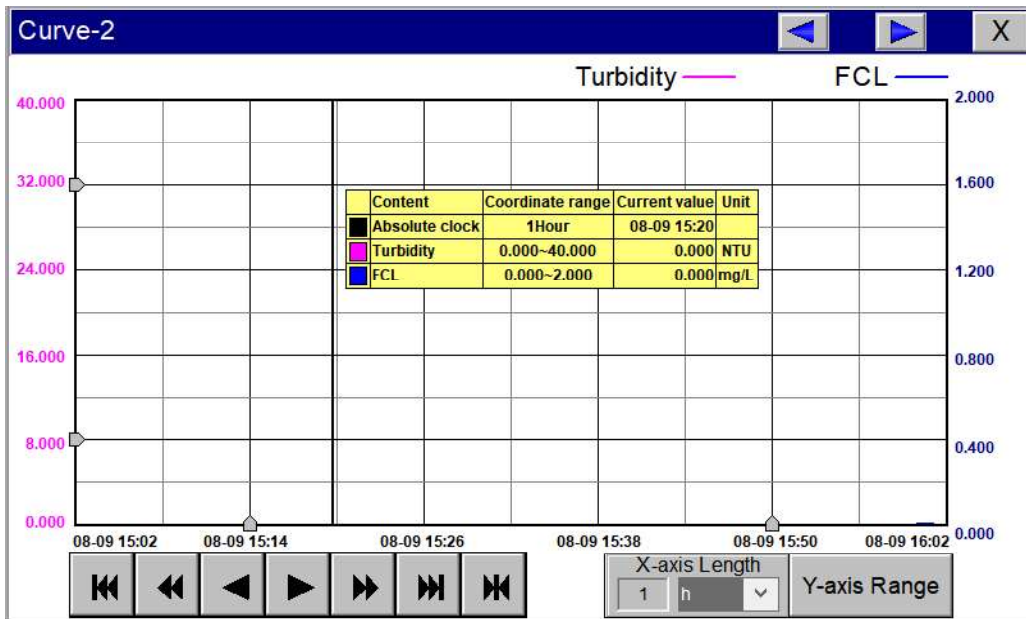
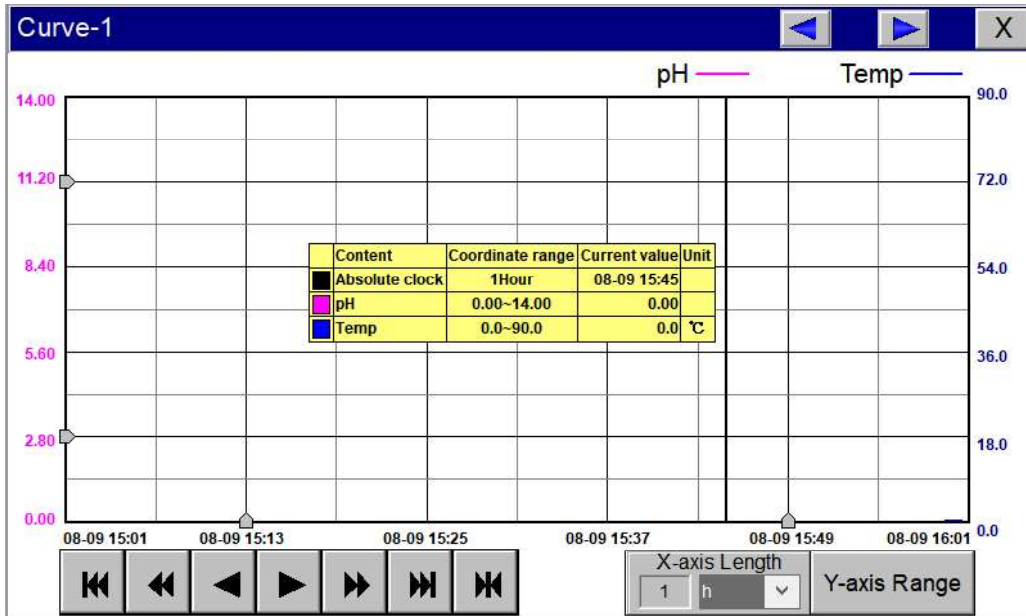

Figure 31 History Curve Screen

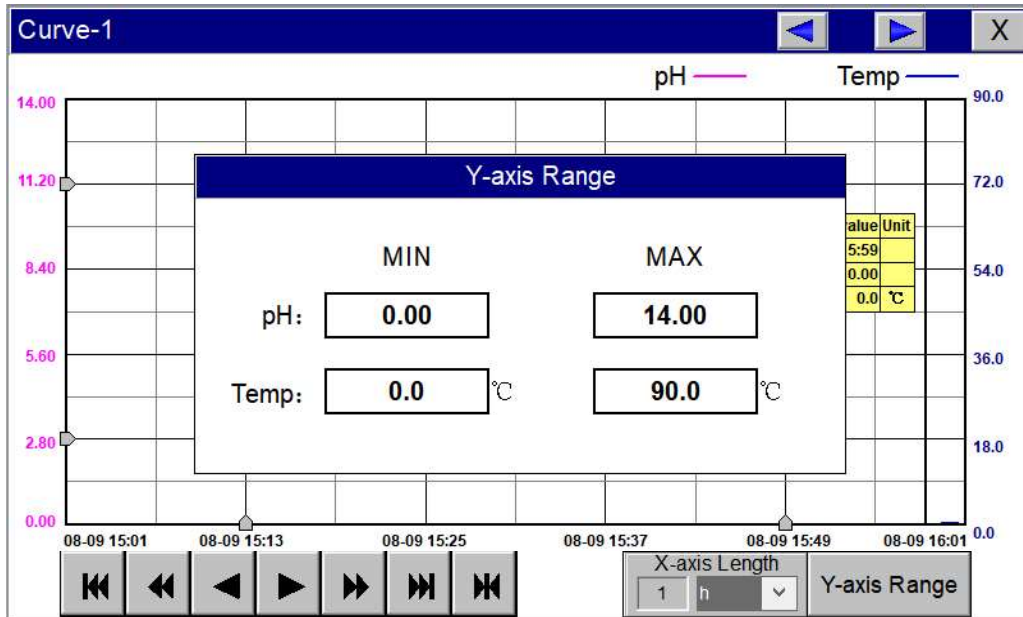

Figure 32 Y-axis Range Setting

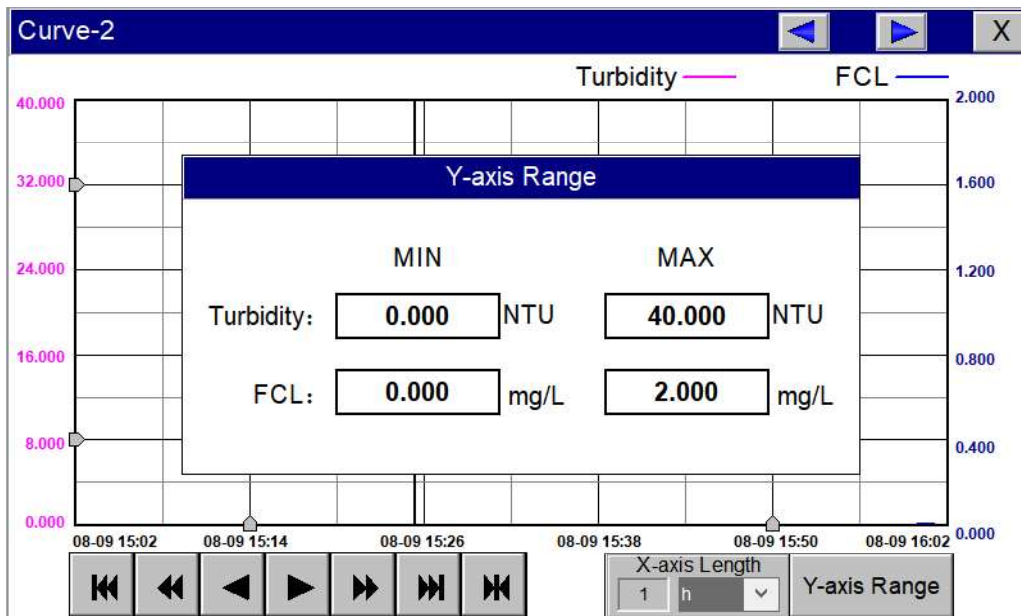

Figure 33 Button Function Review

- ⏪ The curve will scroll back (to the left of the X-axis) one page
- ⏩ The curve will scroll back (to the left of the X-axis) half the page of the curve
- ⏴ The curve will scroll backward (to the left of the X-axis) to a position where the main line is drawn
- ⏵ The curve will scroll forward (to the right of the X-axis) to a position where the main line is drawn
- ⏴⏵ The curve will scroll forward (to the right of the X-axis) half the page of the curve
- ⏴⏴ The curve will scroll forward (to the right of the X-axis) one page
- ⏴⏴⏴ A dialog box will pop up to reset the starting time of the curve

Figure 34 Button Function Review

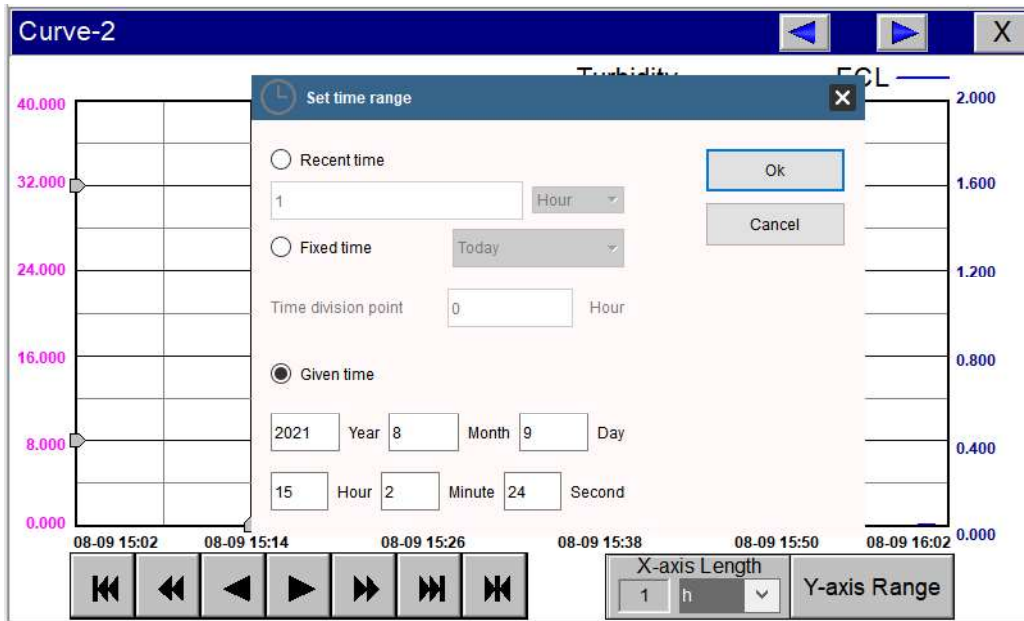

Figure 35 Time Setting Screen

6.11. User Management

Click the “User Management” button on the menu bar and then you can select “Login”, “Logout” and “Manage” operations.

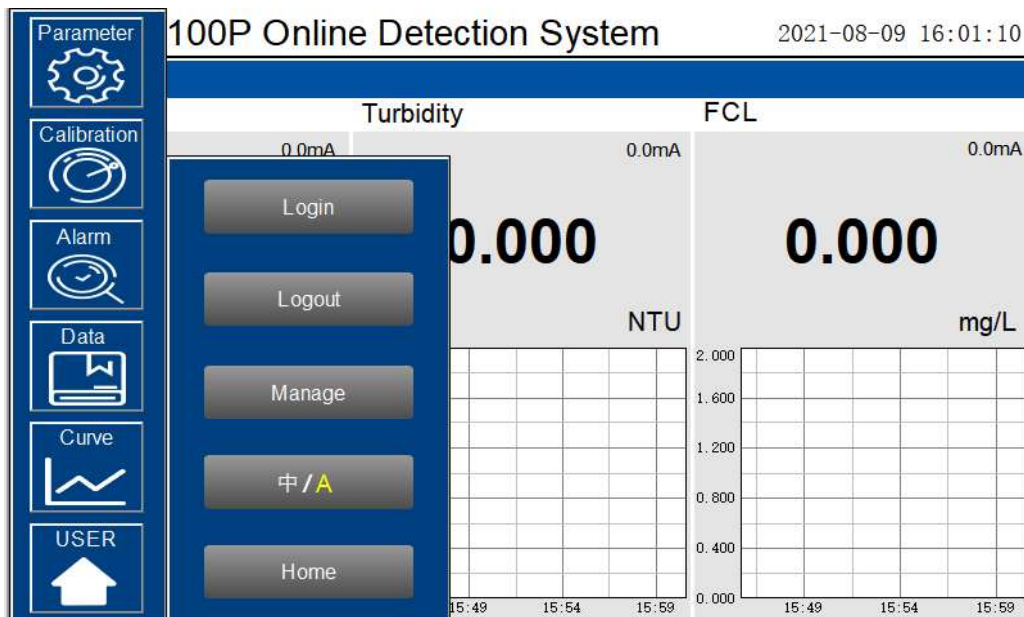

Figure 36 User Management

Logout enables the user to log out of the logged-in state and only view the real-time readings, but cannot perform operations such as parameter settings. Click “Manage” to enter the user management interface, where you can add users, change passwords and other operations. Users can set their own user name and password and select the user group they belong to. Only users in the administrator group can set parameters such as calibration.

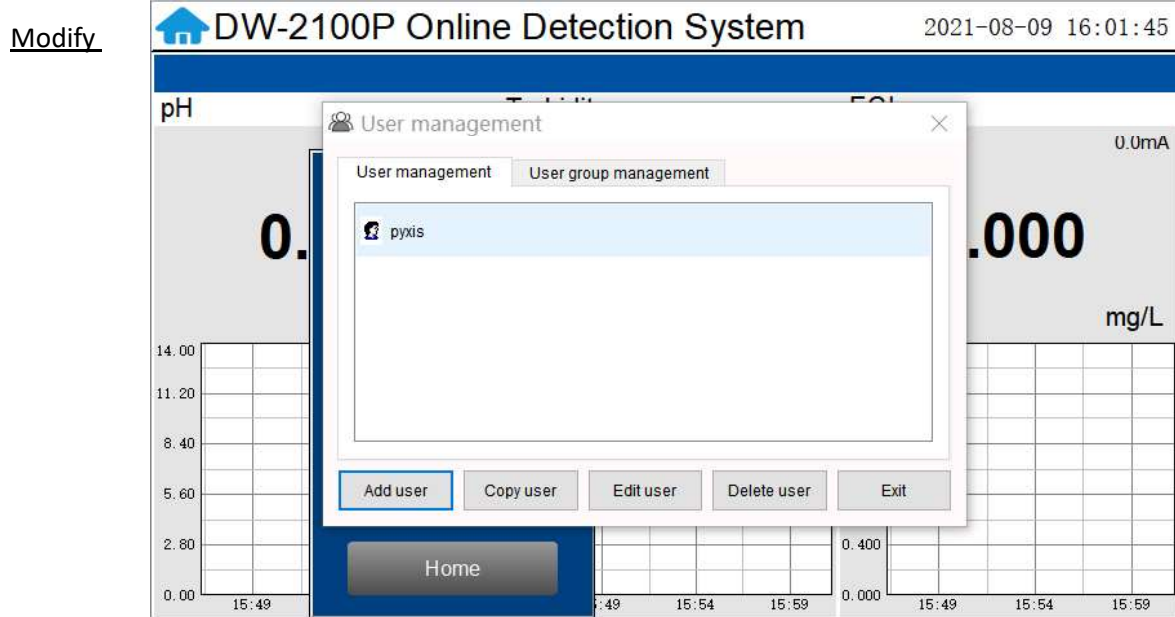

Figure 37 User Management Screen

Password: Select the user you want to change, then click Modify User button, enter the user's own password in the User Password column and Confirm Password column, and click Confirm to modify successfully. ***NOTE*** If you do not want to set the password, you can delete the password and save it.

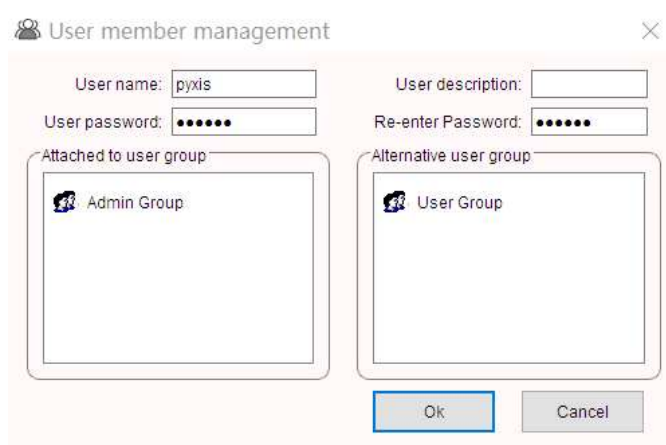

Figure 38 Modifying the User Screen

Daily Maintenance

7.1. Correspondence Address

Number	Definition	Address	Format	Mode	Unit	Note
1	pH	1	float	Read Only	pH	Data format: ABCD
2	Turbidity	3	float	Read Only	NTU	Data format: ABCD
3	Chlorine	5	float	Read Only	mg/L	Data format: ABCD
4	pH Upper Limit Alarm	7	unit	Read Only		0=Normal / 1=Alarm
5	pH Lower Limit Alarm	8	unit	Read Only		0=Normal / 1=Alarm
6	Turbidity Upper Limit Alarm	9	unit	Read Only		0=Normal / 1=Alarm
7	Turbidity Lower Limit Alarm	10	unit	Read Only		0=Normal / 1=Alarm
8	Chlorine Upper Limit Alarm	11	unit	Read Only		0=Normal / 1=Alarm
9	Chlorine Lower Limit Alarm	12	unit	Read Only		0=Normal / 1=Alarm
10	Chlorine / pH Sensor Communication Abnormalities	13	unit	Read Only		0=Normal / 1=Alarm
11	Turbidity Sensor Comm Abnormalities	14	unit	Read Only		0=Normal / 1=Alarm
12	Temperature	15	float	Read Only	oC	Data format: ABCD
13	PLC Comm Error	17	unit	Read Only		0=Normal / 1=Alarm
14	Cleaning Module Comm Error	18	unit	Read Only		0=Normal / 1=Alarm
15	Brush Working Error	19	unit	Read Only		0=Normal / 1=Alarm
16	4-20mA Comm Error	20	unit	Read Only		0=Normal / 1=Alarm
17	TDS/Cond	21	float	Read Only	ppm- μS/cm	Data format: ABCD
18	TDS/Cond upper limit alarm	23	uint	Read Only		0=Normal / 1=Alarm
19	TDS/Cond lower limit alarm	24	uint	Read Only		0=Normal / 1=Alarm
20	TDS/Cond sensor communication is abnormal	25	uint	Read Only		0=Normal/ 1=Alarm
21	Panel Flow	26	float	Read Only	L / Min	Data format: ABCD
Communication Protocol: Standard Modbus-RTU						
Communication Parameters: Baud Rate - 9600, Data Bit - 8, Stop Bit - 1, Parity Bit - Even						
Station Number: 100						
Communication protocol: standard Modbus-TCP						
Communication parameters: IP: 192.168.0.3 (can be set); port: 502						
Station number: 1						

Table 2 - Correspondence Address

7.2. Operation and Maintenance

After the analyzer is installed by a qualified technician, it can begin to monitor water quality. The DW-2100P inline detection system is designed to be simple to operate, but still requires some regular maintenance. Actual system maintenance may vary depending on the installation conditions and usage. Please refer to the table below as a general recommended maintenance schedule.

Minimal operator intervention is required during normal operation.

Required Services	Recommended Frequency
Cleaning DW-2100P Inlet Water Filter	Monthly or Cleaned As Needed
Cleaning of FR-200 Flow Reservoir and Photoelectric Pole	Monthly
pH Calibration	Every 6 Months
Turbidity Calibration	Every 6 Months
Residual Chlorine Calibration	Every 6 Months

Table 3 - Maintenance Intervals

7.3. Instrument Alarms and Descriptions

Please refer to the instrument alarms and descriptions table when troubleshooting the DW2100P inline inspection system issues an alarm or indicates abnormal measurement data.

Alarms	Description	Symptoms	Solutions/Recommendations
PLC Communication Abnormalities	PLC without Communication		Check if the wiring inside the PLC and control box is loose
Turbidity Sensor Communication Abnormality	Turbidity Sensor without Communication	No Turbidity Measurements	Check the connection between the sensor and the circuit board. If the problem persists, contact Pyxis.
pH / Residual Chlorine Sensor Communication Abnormalities	pH / Residual Chlorine Sensor without Communication	No pH and Residual Chlorine Measurements	
pH Upper Limit Alarm	pH above the Alarm Setting	Information Only	
pH Lower Limit Alarm	pH below the Alarm Setting	Information Only	Compare with manual measurement readings. Check and clean line valves. Check that water flow is normal. Check that the sensor is clean.
Turbidity Upper Limit Alarm	Turbidity above the Alarm Setting	Information Only	
Turbidity Lower Limit Alarm	Turbidity below the Alarm Setting	Information Only	
Residual Chlorine Upper Limit Alarm	Residual Chlorine above the Alarm Setting	Information Only	
Residual Chlorine Lower Limit Alarm	Residual Chlorine below the Alarm Setting	Information Only	
Turbidity Calibration Failure Code 259	Low Calibration Standard Solution out of Range	Turbidity Calibration Failure	Check that the flow cell and sensor are clean and that the standard solution is not contaminated
Turbidity Calibration Failure Code 260	Mid Calibration Standard Solution out of Range	Turbidity Calibration Failure	
Turbidity Calibration Failure Code 261	High Calibration Standard Solution out of Range	Turbidity Calibration Failure	
Turbidity Calibration Failure Code 262	Slope f1 out of Range	Turbidity Calibration Failure	
Turbidity Calibration Failure Code 263	Slope f2 out of Range	Turbidity Calibration Failure	
pH/Residual Chlorine Calibration Failure Code 2		Calibration Failure	Check whether the water flow is normal, whether the sensor is clean, whether the standard liquid is contaminated
pH/Residual Chlorine Calibration Failure Code 3	Standard Solution Value out of Range	Calibration Failure	
pH/Residual Chlorine Calibration Failure Code 5	Wrong Data Type for the Liquid Value	Calibration Failure	

Table 4 - Common Alarms

8. Replacing pH and Oxidizer Electrode Head

The pH/oxidizer electrode head of ST-765SS Series can be replaced when the original electrode head reaches its working life. Order a replacement electrode head EH-765 (P/N 53061) from Pyxis and follow instructions as below.

1. Turn off the sensor if it is powered on.
2. Make sure there is no water on the sensor.
3. Hold the ST-765SS main body with one hand and use the other hand to twist the stainless-steel locking ring counter-clockwise until the front end of the black electrode is completely unscrewed, as shown in *Figure 39-2*.
4. Pull out the electrode head as shown in *Figure 39-3*.
5. Loosen the electrode plug connector, and remove the electrode head, as show in *Figure 39-4*.
6. To assemble the new electrode head, connect the plug, then insert the new electrode head into the main sensor housing and ensure that the two protrusions on the electrode head are aligned with the notches in the sensor main housing.
7. Then twist the stainless-steel lock ring of ST-765SS in a clockwise direction until the threads of the electrode head completely enter the ST-765SS housing as shown in *Figure 39-1*.

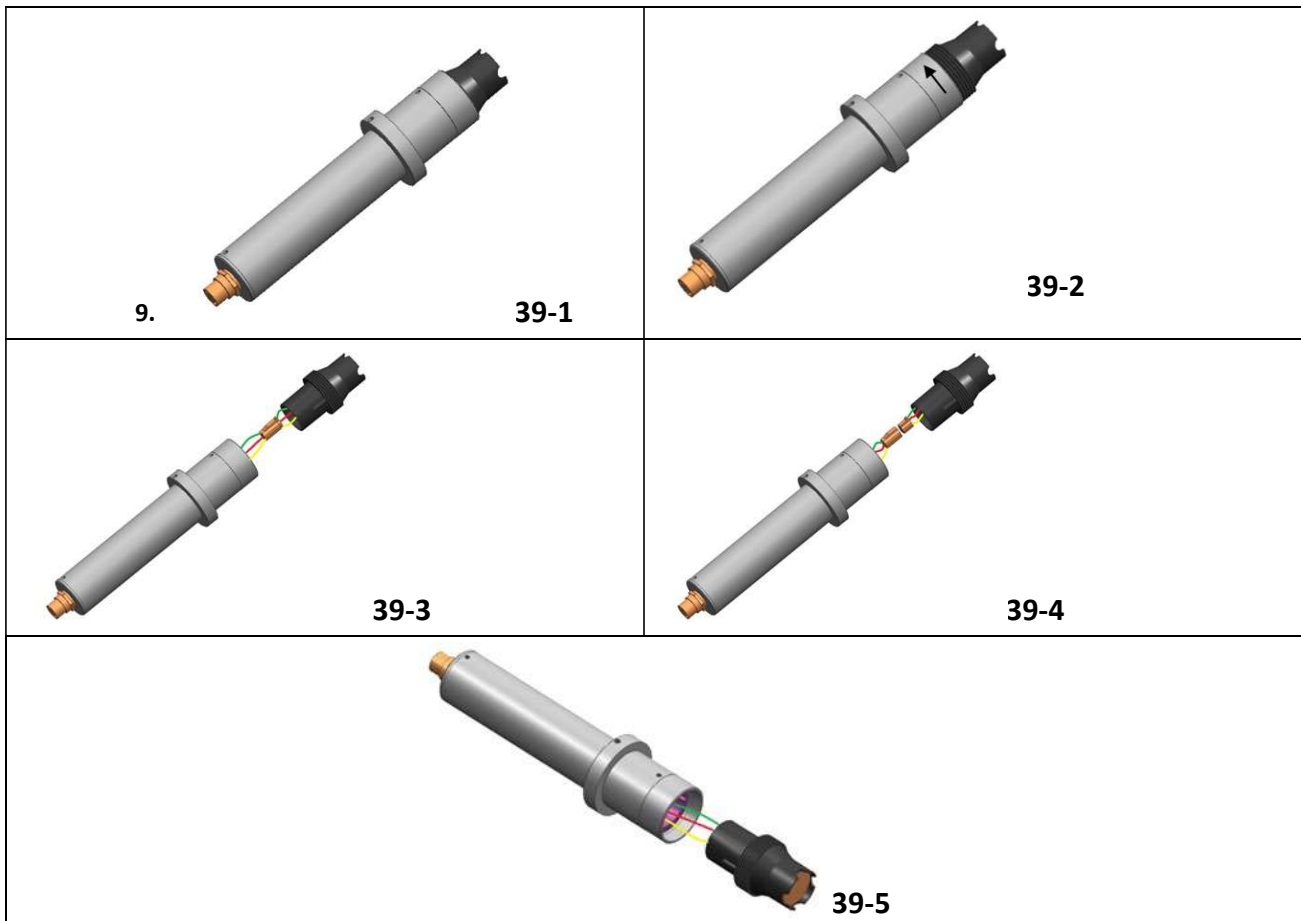

Figure 39 - Replacing EH-765 pH and Oxidizer Electrode Head

9. UC-80 & UC-100 Series

Setting the Date and Time and Firmware Update Procedure

9.1. Setting the Date and Time

- 1) When the device is powered on again, when the following screen appears on the screen, tap the screen immediately

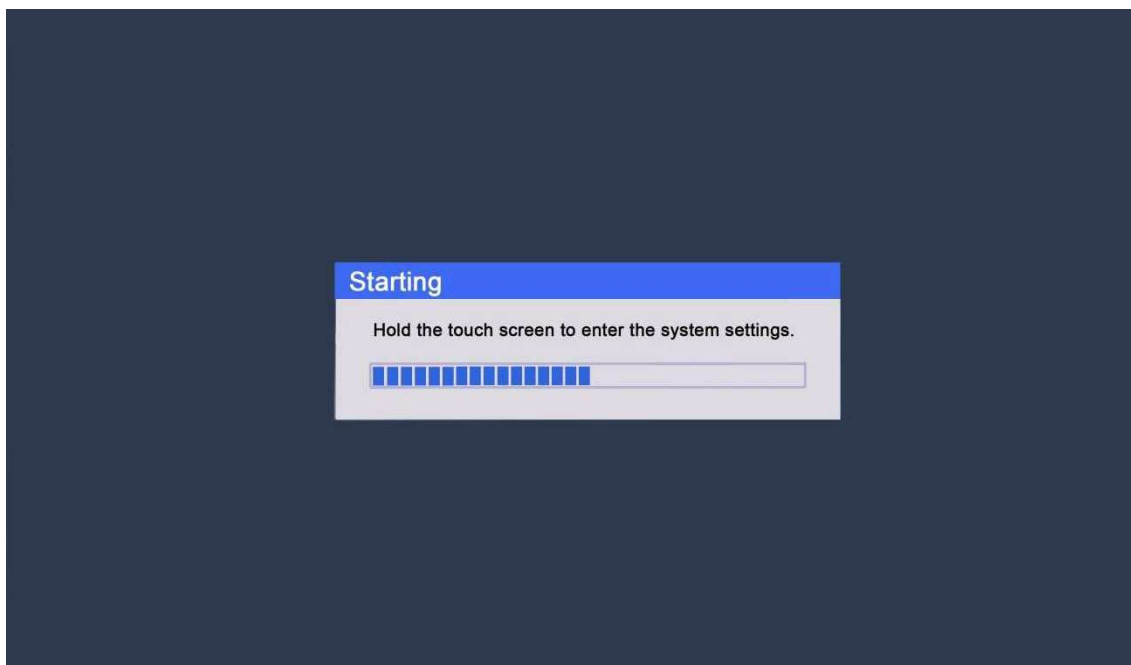

- 2) Enter the system interface, as shown in the figure below, click the button "System setting"

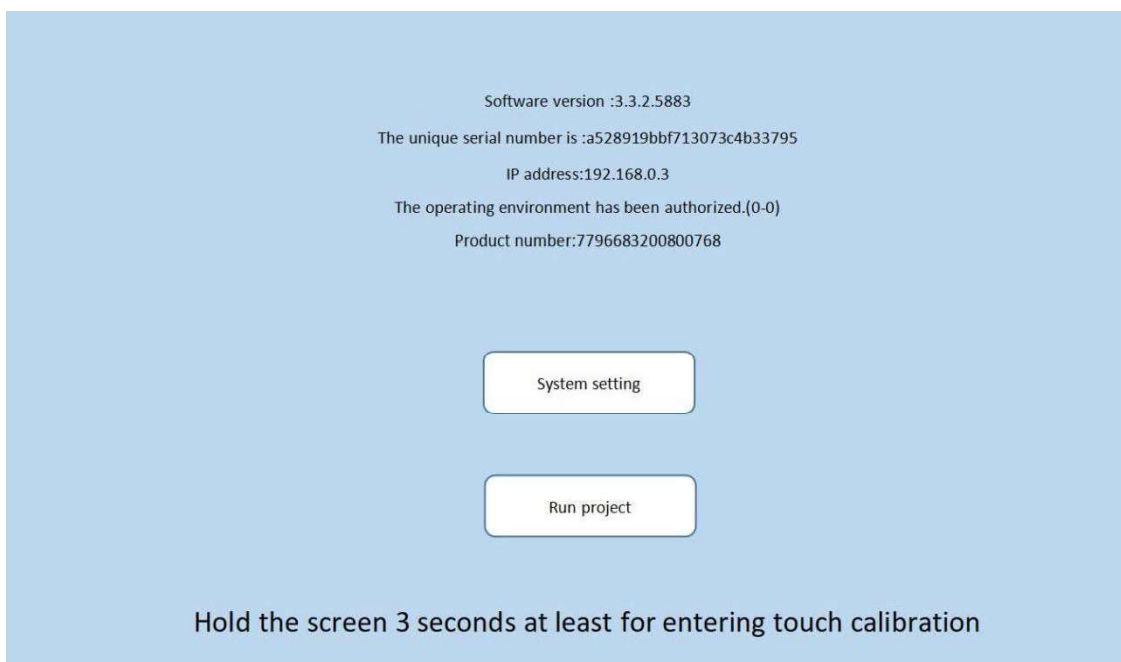

- 3) Enter the setting interface, select the time parameters, as shown in the figure below, and modify the time. After the modification is completed, click the "OK" button to confirm. After closing the setting interface, click "Run project" to enter the program running interface.

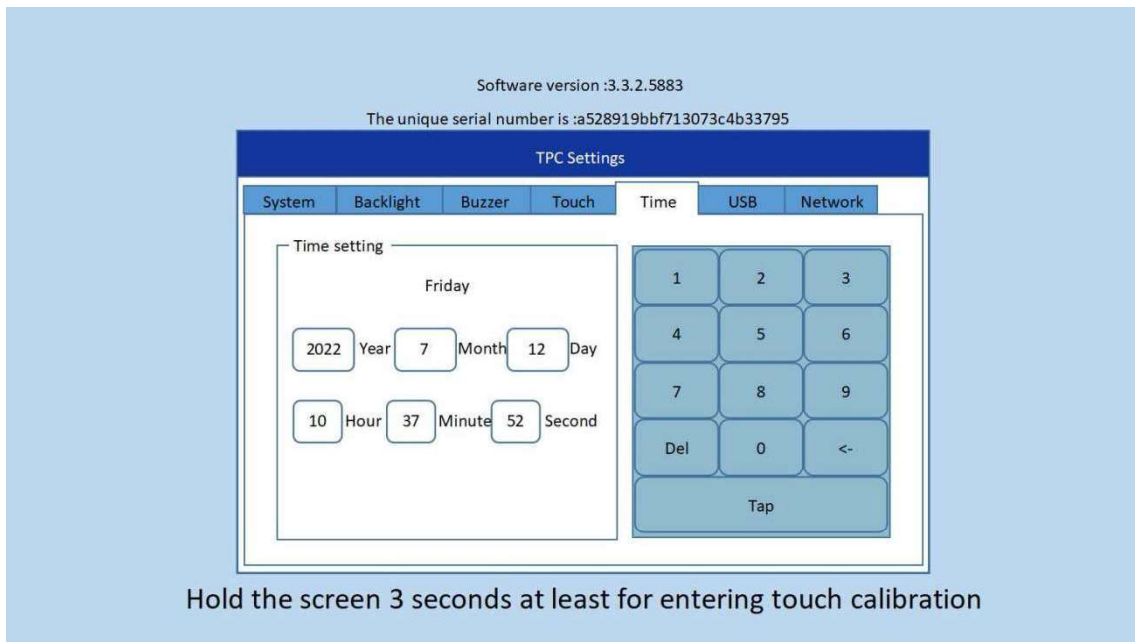

9.2. Firmware Update Procedure

- 1) Decompress the program update package, copy the "**tpcbbackup**" file and save it to a USB flash drive in "FAT32" format. ***NOTE*** You need to copy the entire folder to the root directory of the USB flash drive.
- 2) Insert the USB flash drive into the USB1 port on the rear of the touch screen.
- 3) After inserting the USB flash drive, the touch screen will pop up. Click "**YES**" and wait for the screen to jump, as shown below.

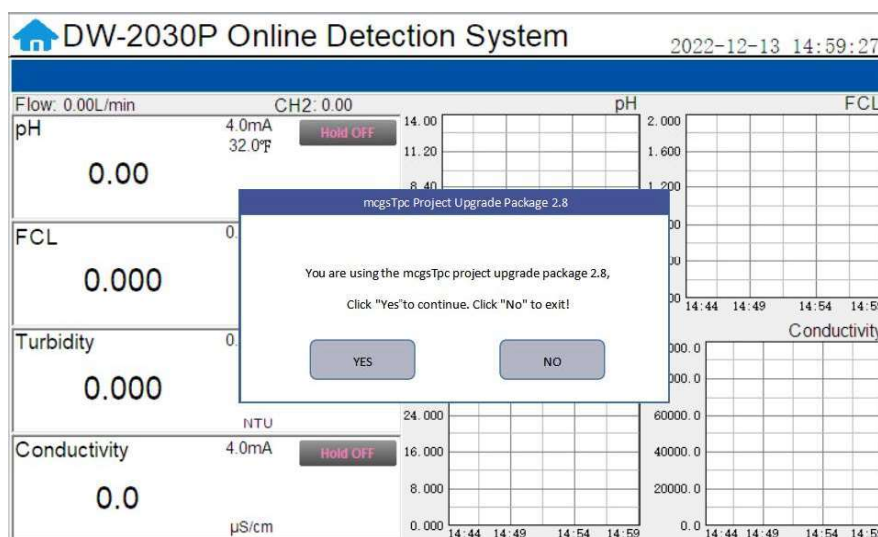

- 4) In the new pop-up box, click "**Download Project**", as shown below.

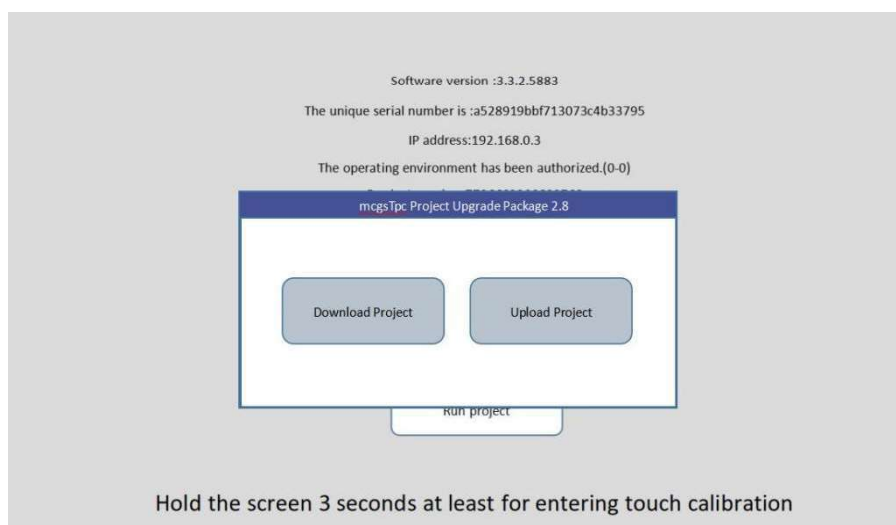

- 5) In the new pop-up box, select the program name on the left and click "**Download**". The touch screen will start to download the program. See figure below

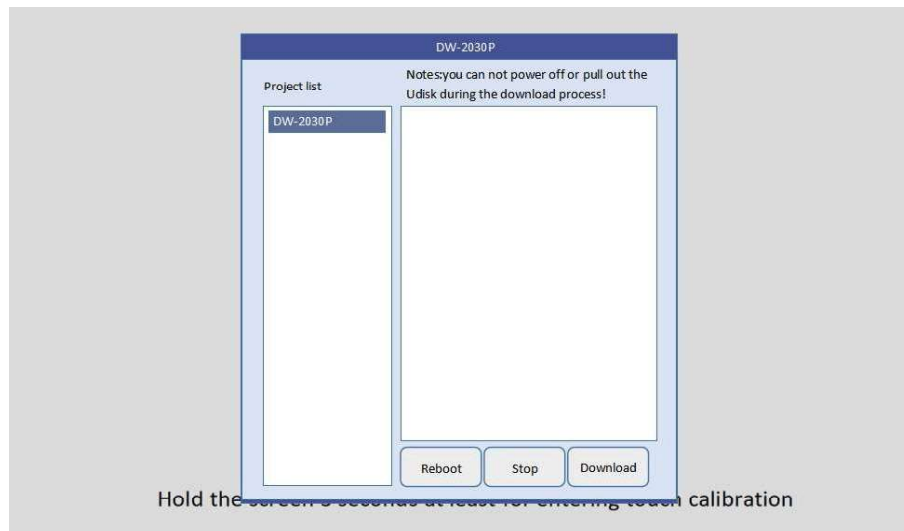

- 6) When the rewind is over, the touch screen will restart, and the screen will turn black during the restart. At this time, you can pull out the USB disk, as shown in Figure 4

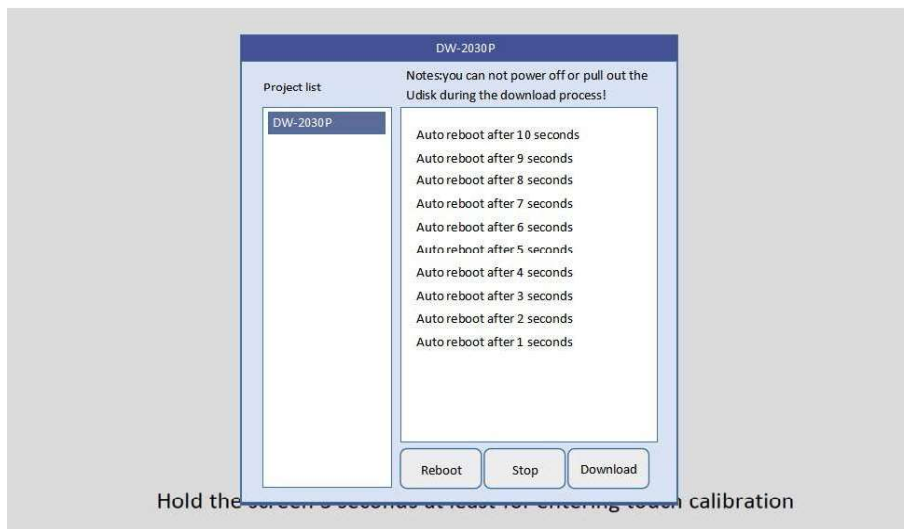

- 7) If the update screen appears again after restart, please click "NO" and pull out the USB disk, as shown in Figure 5

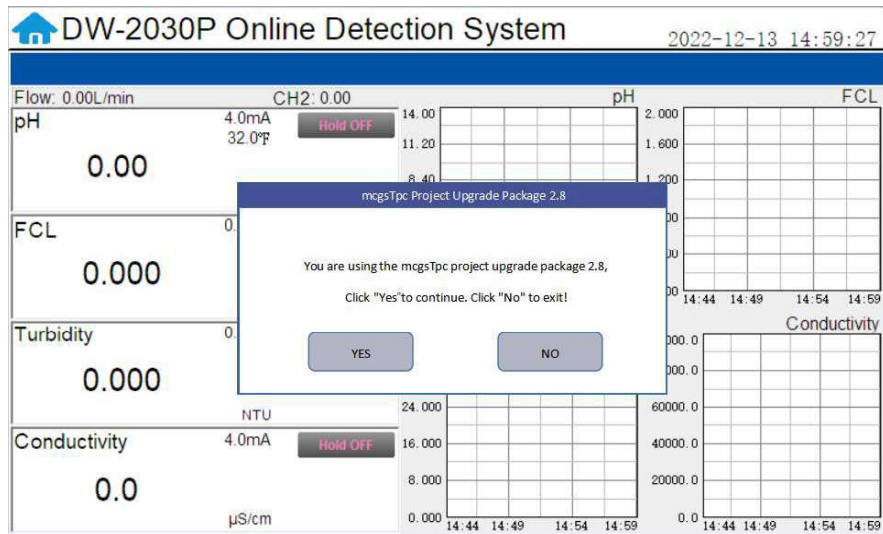

10. Order Information

Order Information

	P/N
DW-2100P-US (<i>Drinking Water Analyzer for EPA-180.1 Compliant Markets</i>)	42135
DW-2100P-EU (<i>Drinking Water Analyzer for ISO-7027 Compliant Markets</i>)	42136
DW-2100P-US-G (<i>DW-2100P-US with optional Pyxis CloudLink™ 4G Gateway</i>)	42137
DW-2100P-EU-G (<i>DW-2100P-EU with optional Pyxis CloudLink™ 4G Gateway</i>)	42138

Optional / Replacement Accessories Information

	P/N
LT-739 Ultra-Low Turbidity (<i>Warm White LED 0.000-40.00 NTU</i>)	53221
LT-739B Ultra-Low Turbidity (<i>InfraRed 860nm LED 0.000-40.00 NTU</i>)	53225
ST-765SS-FCL (<i>Free Chlorine + pH + Temperature Sensor w/Internal Compensation – Sensor Only</i>)	53607-NFR
EH-765 (<i>Replacement Electrode Head for ST-765SS-FCL</i>)	53061
FR-200 Dual Sensor Flow Reservoir Assembly	50781
FRP-200 (<i>Motorized Brush Cleaning Module for FR-200</i>)	50700-A17
FRP-200-1 (<i>Replacement Brush for FRP-200</i>)	50700-A15
L-CAL (<i>Portable Liquid Formazin Calibration Kit for LT-73X Series Sensors</i>)	53247
LT-SOLID-CAL 739 (<i>Solid State Calibration Kit for LT-739 - 0.1 / 8.0 / 25 NTU</i>)	53229
LT-SOLID-CAL 739B (<i>Solid State Calibration Kit for LT-739B - 0.1 / 8.0 / 25 NTU</i>)	53239
Pyxis Turbidity Calibration Std – 10.0 NTU (<i>4,000mL</i>)	57010-10L
Pyxis Turbidity Calibration Std – 30.0 NTU (<i>4,000mL</i>)	57010-30L
Pyxis pH Combo Calibration Pack (<i>pH 4-7-10 Calibration Solution 3-Pack - 500mL ea.</i>)	57007
Global Prepaid SIM Card for Wireless Data Access (<i>1-Year</i>)	CLD-SIM-01

Table 5 Order Information