

# OXIPAN<sup>®</sup>L

*Industrial Water*

## IK-765SS-B Series

### Oxidizer + pH Inline Analyzers

### For Industrial Cooling & Process Water

### Startup Guide



Pyxis Lab Inc.

August 2023

## Table of Contents

**SPECIFICATIONS..... 5**

**IK-765SS-B Series Panel Dimensions (mm)..... 6**

**IK-765SS-B Series FR-300-PUS – Flow Reservoir Dimensions (mm) ..... 6**

**FR-300-PLUS Component Schematic..... 7**

**FRP-300-01 Replacement Brushing Assembly Dimensions (mm) & Image ..... 7**

**FRP-300-01 Replacement Brushing Assembly Replacement Procedure ..... 8**

**FR-300-PLUS Flow & Operation ..... 9**

**UC-50 Display/Data Logger Dimensions (mm) .....10**

**ST-765SS Series Sensor Dimensions (mm) .....10**

**UC-50 ACCESS PASSWORD..... 11**

**UC-50 TERMINAL BOARD WIRING DIAGRAM .....12**

**UC-50 OUTPUT SIGNAL/RELAY WIRING DETAILS AND 4-20mA RANGES.....13**

**SETTING DATE & TIME ON UC-50 DISPLAY .....15**

**TEMPERATURE UNIT of MEASURE SETUP PROCEDURE .....15**

**UC-50 SETUP OF USER DEFINED SIGNAL INPUT FEATURE.....16**

**UC-50 SETUP OF USER DEFINED ANALOG OUTPUT FEATURE .....18**

**UC-50 RELAY CONFIGURATION .....19**

**ZERO OXIDIZER - CALIBRATION PROCEDURE.....21**

**pH – CALIBRATION PROCEDURE .....22**

**RESTORING FACTORY PARAMETERS & PROBE DIAGNOSIS .....25**

**USB FUNCTION FOR HISTORICAL DATA UPLOAD AND FREQUENCY .....26**

**EXPORT UC-50 HISTORICAL DATA .....26**

**ADJUST UC-50 HISTORICAL DATA LOG INTERVAL .....27**

**UPGRADE UC-50 FIRMWARE .....27**

**EXPLANATION & USE OF THE SIGNAL HOLD FEATURE .....28**

**SENSOR CLEANING & MAINTENANCE.....30**

**COMMON SENSOR TROUBLESHOOTING.....30**

**REPLACING pH / OXIDIZER ELECTRODE HEAD .....31**

**IK-765-B SERIES AND ACCESSORIES ORDER INFOR.....32**

**ORDER INFORMATION.....32**

## PRODUCT DESCRIPTION

The IK-765-B series are dual-parameter inline water analyzers specifically designed as a 'Turn-Key' monitoring solution for challenging water applications including cooling water, food and industrial process water, raw water and treated wastewater effluent applications. The IK-765-B series offers highly accurate, real-time measurement, display and data-logging of up two oxidizer measurement formats as well as pH and Temperature utilizing proprietary Pyxis Lab smart sensor technology, coupled with a Pyxis UC-50 micro display and data logging terminal. The IK-765-B also incorporates a uniquely designed automated mechanical brush flow assembly which is directly controlled via the UC-50 display to maintain optimum sensor electrode cleanliness in the most challenging of system water. The IK-765-B series is offered in a convenient and easy to integrate panel mounted format for rapid installation and simple maintenance.

The IK-765-B series analyzer is offered in four sensor formats depending on the desired oxidant being measured. The panel design is equipped with the propriety Pyxis ST-765SS Series smart sensors based on application needs. The ST-765SS series sensors measure Free Chlorine (FCL), Bromine (Br), Chlorine Dioxide (CLO) or DBNPA in addition to pH and temperature of the sample water. This Pyxis sensor design is membrane-free and based on unique principles and incorporates Pyxis' advanced technology in the field of bare-gold electrochemical detection. The ST-765SS-FCL (Free Chlorine + pH), ST-765SS-Br (Bromine + pH), ST-765SS-CLO (Chlorine Dioxide + pH) and ST-765SS-DBNPA (DBNPA + pH) sensors measure the oxidant level and pH simultaneously while performing temperature and pH compensation for the measurement of oxidant based on conditions present in the application of use. Each IK-765-B panel is also equipped with the FR-300-PLUS mechanical brushing flow assembly to ensure constant electrode cleanliness and UC-50 micro display/data logging terminal prewired to the ST-765SS series sensor of in RS-485 Modbus format with fully integrated sensor diagnostics and calibration interface. This unique platform with internal sensor compensation results in a highly accurate oxidizer measurement consistent with DPD wet chemistry methodology as high as pH 9.0+ and meets EPA-334.0 and ISO-7393 compliance.

## TURN-KEY INSTALLATION

The IK-765-B series analyzer requires a small installation footprint, offers auto-brush-cleaning operation with simple maintenance, and is specifically designed for use in challenging industrial cooling and process applications. The analyzers sensor data may be downloaded via USB drive or connected to a receiving device via RS-485 output or 1x 4-20mA output from the UC-50 display/data logging terminal. Users may utilize the 2x 4-20mA outputs directly from the ST-765SS series sensor for terminating to an alternative controller or device, while the sensor is simultaneously connected to the UC-50 in RTU.

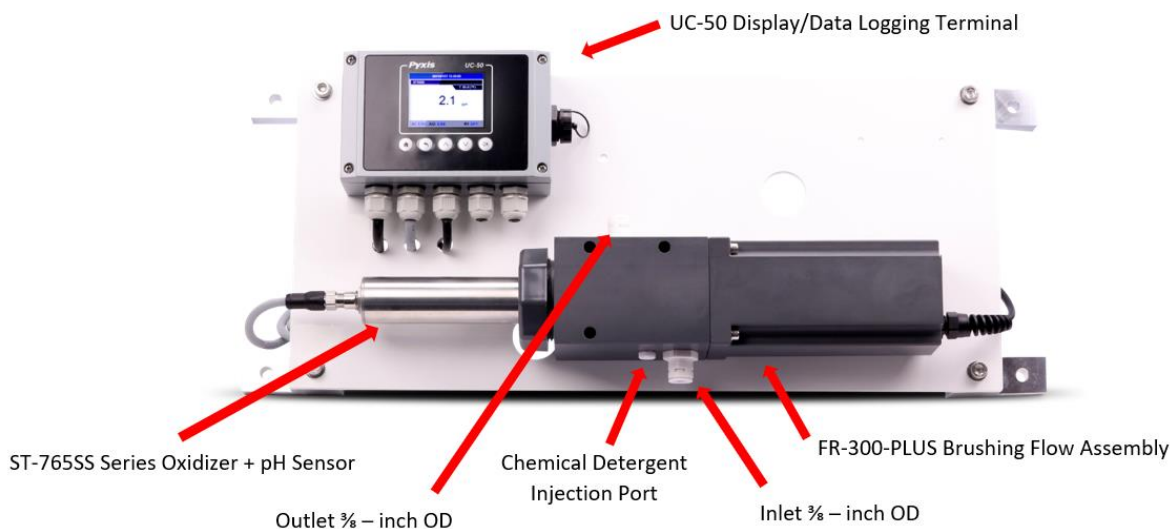

## FEATURES

- Pyxis ST-765SS-FCL (Free Chlorine + pH/Temperature), ST-765SS-Br (Bromine + pH/Temperature), ST-765SS-CLO (Chlorine Dioxide + pH/Temperature) are three-parameter composite sensors used for the measurement residual Free Chlorine, Bromine and Chlorine Dioxide as well as pH and temperature in compliance with USEPA 334.0 and ISO-7393 guidelines. The sensors advanced PCB offers built-in temperature and pH parameter compensation (up to pH 9.0+) algorithms eliminating the need for a supplemental pH sensor and controller. Unique Bare-Gold electrode technology for residual oxidizer measurement eliminates membranes and electrode solution replenishment commonly associated with conventional sensors. The ST-765SS Series have a uniquely designed flat bubble pH electrode design for reduced fouling potential. Reduce your maintenance and cost versus colorimetric chlorine measurement or conventional electrochemical sensors by utilizing Pyxis replaceable Electrode Head (EH-765) for this sensor allowing for years of reliable service. The ST-765SS Series may be calibrated in-situ after cleaning via DPD Free Chlorine, Bromine or Chlorine Dioxide wet chemistry test measurement of active sample.
- The Pyxis FR-300-PLUS is magnetic coupling motorized brush flow assembly that provides an inline mechanical cleaning of the ST-765SS Series bare gold electrode enabling sensor accuracy in challenging industrial cooling and process waters. This unique device enhances the convective mass transport of the oxidizer analyte to the sensor surface eliminating the need for precision flow control commonly required for other amperometric sensors on the market. The FR-300-PLUS also provides supplemental deactivation protection of the bare gold electrode for long life, stability, and accuracy. The brushing frequency and rotational speed are preset and controlled via RS-485 from the UC-50 display/data logging terminal. The FR-300-PLUS also contains a 'chemical detergent injection port' in the assembly housing allowing for the optional injection of cleaning agents at the brush head for extremely challenged industrial waters containing oils and grease. The FR-300-PLUS may be operated at a broad range of sample flow from 200 and 800mL per minute with an inlet pressure of  $\leq 30$  psi. The FR-300-PLUS outlet flow line may be diverted to drain or returned to an atmospheric tank/sump within the process itself for reuse.
- Simple sensor removal and replacement. The ST-765SS Series sensors are connected to the display/data logger via RS-485 Modbus (RTU) allowing for integrated sensor calibration interface and diagnostics within the display screen. Convenient and simple to install Back-Panel (IK-765-B Series) for rapid and easy installation. Truly a plumb and power to go platform with intense factory setup, testing and sensor calibration prior to shipment.
- UC-50 micro display/data logger interface with sensor calibration integrated. Display/data logger offers 1x 4-20mA I/O as well as RS-485 with remote diagnosis and parameter adjustment.

**SPECIFICATIONS**

Item	IK-765SS-FCL-B	IK-765SS-CLO-B	IK-765SS-Br-B
P/N	42169	42170	44074
Sensor Body Material	304SS		
Sensor Name	ST-765SS-FCL	ST-765SS-CLO	ST-765SS-Br
Oxidizer Measured	Free Chlorine	Chlorine Dioxide	Bromine
Oxidizer Range	0.00-5.00 ppm		
Oxidizer Precision	± 0.01mg/L or 1% of the value w/pH compensation up to 9.0		
pH Range	0-14		
pH Precision	± 0.01 pH		
Sample Operating Temperature	4 °C – 40 °C (40 – 104 °F)		
Sample Inlet Pressure	7.25 – 30 psi (0.05 – 0.2MPa)		
Sensor Response Time	T95≤60s – Oxidant / T95≤5s - pH		
Measurement Interval	Continuous		
Installation	FR-300-PLUS Magnetic Coupling Brushing Flow Reservoir Included		
FR-300+ Suggested Flow Rate	200 – 800 mL/minute		
FR-300+ Sample Inlet /Outlet	3/8 - inch OD		
FR-300+ Operation	RS-485 Controlled Pre-Set Constant On Mode		
FR-300+ Rotational Speed	200 RPM – Motorized Brush Preset for Constant Operation		
UC-50 Display	2.8" Color 320 x 240 Resolution		
UC-50 Input	1 x 4-20 mA / RS-485 Modbus-RTU		
UC-50 Output	2 x 4-20 mA from ST-765 Sensor / RS-485 Modbus-RTU / 1 x Contact Relay		
UC-50 Relay	1x Channel Relay Output 24VDC /10 Watt Max Available		
UC-50 Data Storage	32 M Flash		
UC-50 USB	1 x USB host for data downloading		
UC-50 Relative Humidity	5% - 95% (No Condensation)		
UC-50 Altitude	<6,561 feet (<2,000 Meter)		
Panel Power Supply	110/220VAC 50/60 Hz, 0.6A		
Panel Storage Temperature	-4 – 158 °F (-20 – 70 °C)		
Panel Operating Temperature	32 – 122 °F (-0 – 50 °C)		
Panel Dimension (H x W x D)	Panel (IK-765-B Series) 250H x 590W x 128D mm		
Panel Approximate Weight	Panel (IK-765-B Series) ~ 8 kg		
Panel Wet Material	UPVC / Polycarbonate		
Rating	IP-65 Panel-Display / IP-67 Sensors		
Selectivity	Non-Selective, cross sensitive to other oxidizing species		
Compliance	EPA 334.0 / ISO 7393		
Regulation	CE Marked / RoHS		
Typical Electrode Service Life	2 years		
Electrode Warranty	6 Months		
Sensor Body Warranty	13 Months		

*\*NOTE\* - Pyxis Lab is consistently updating technologies, as such, specifications may change without notice.*

*Technical specifications on the ST-765SS Series sensors can also be found in the ST-765SS Series Operation Manual.*

*Contact [info@pyxis-lab.com](mailto:info@pyxis-lab.com) for details or [www.pyxis-lab.com](http://www.pyxis-lab.com).*

**IK-765SS-B Series Panel Dimensions (mm)**

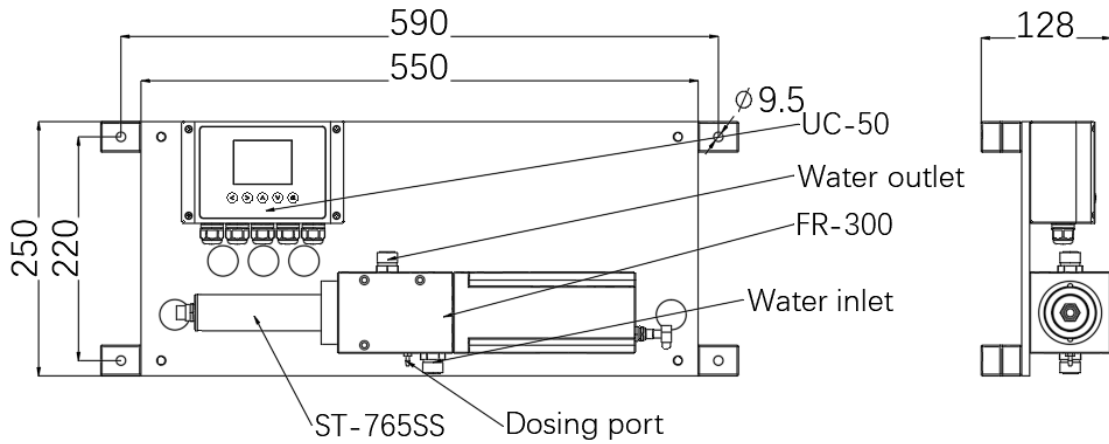

**IK-765SS-B Series FR-300-PUS – Flow Reservoir Dimensions (mm)**

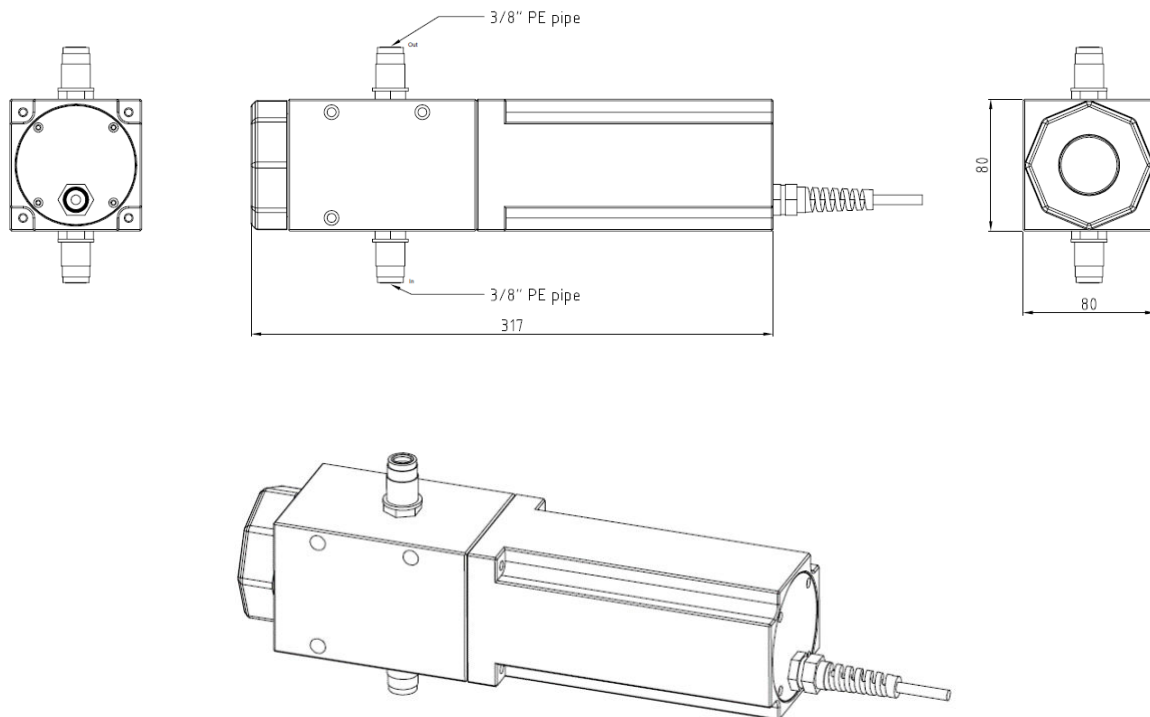

### FR-300-PLUS Component Schematic

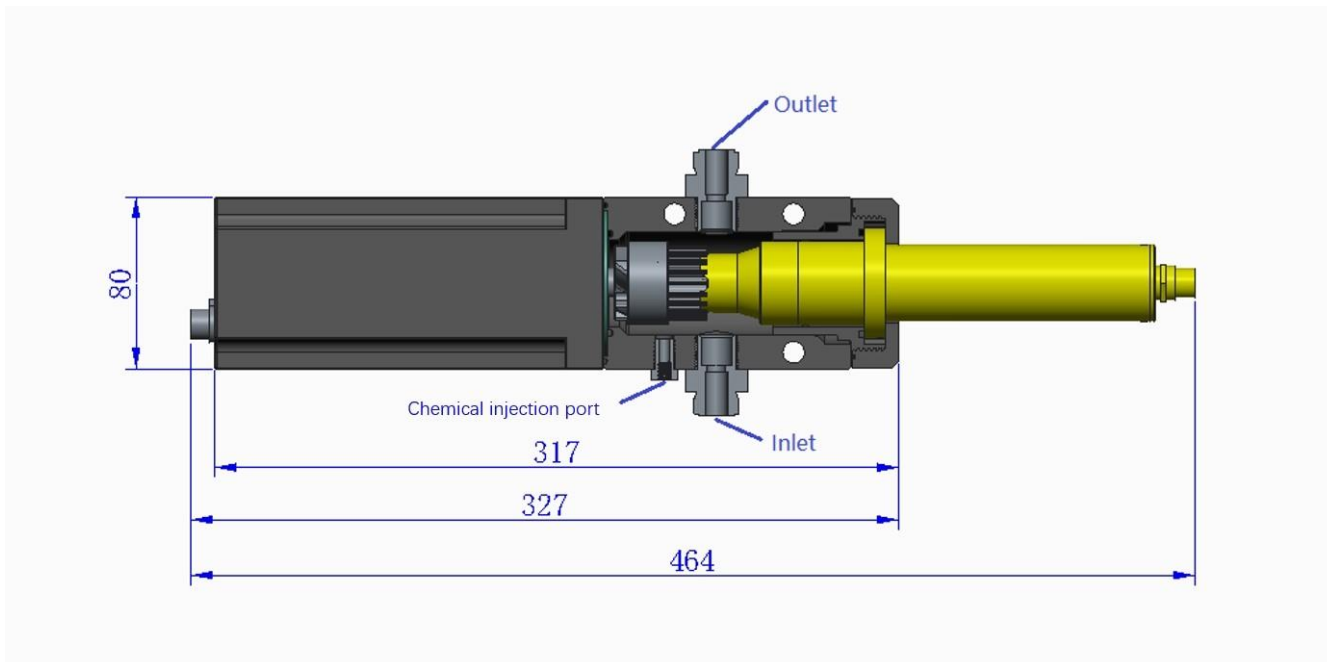

### FRP-300-01 Replacement Brushing Assembly Dimensions (mm) & Image

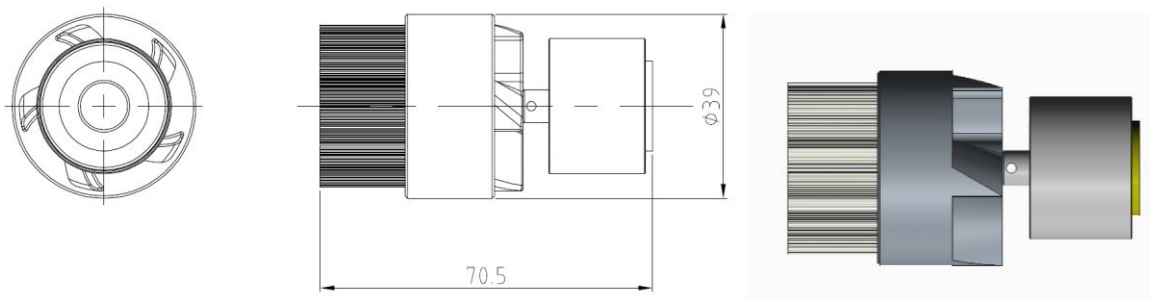

## FRP-300-01 Replacement Brushing Assembly Replacement Procedure

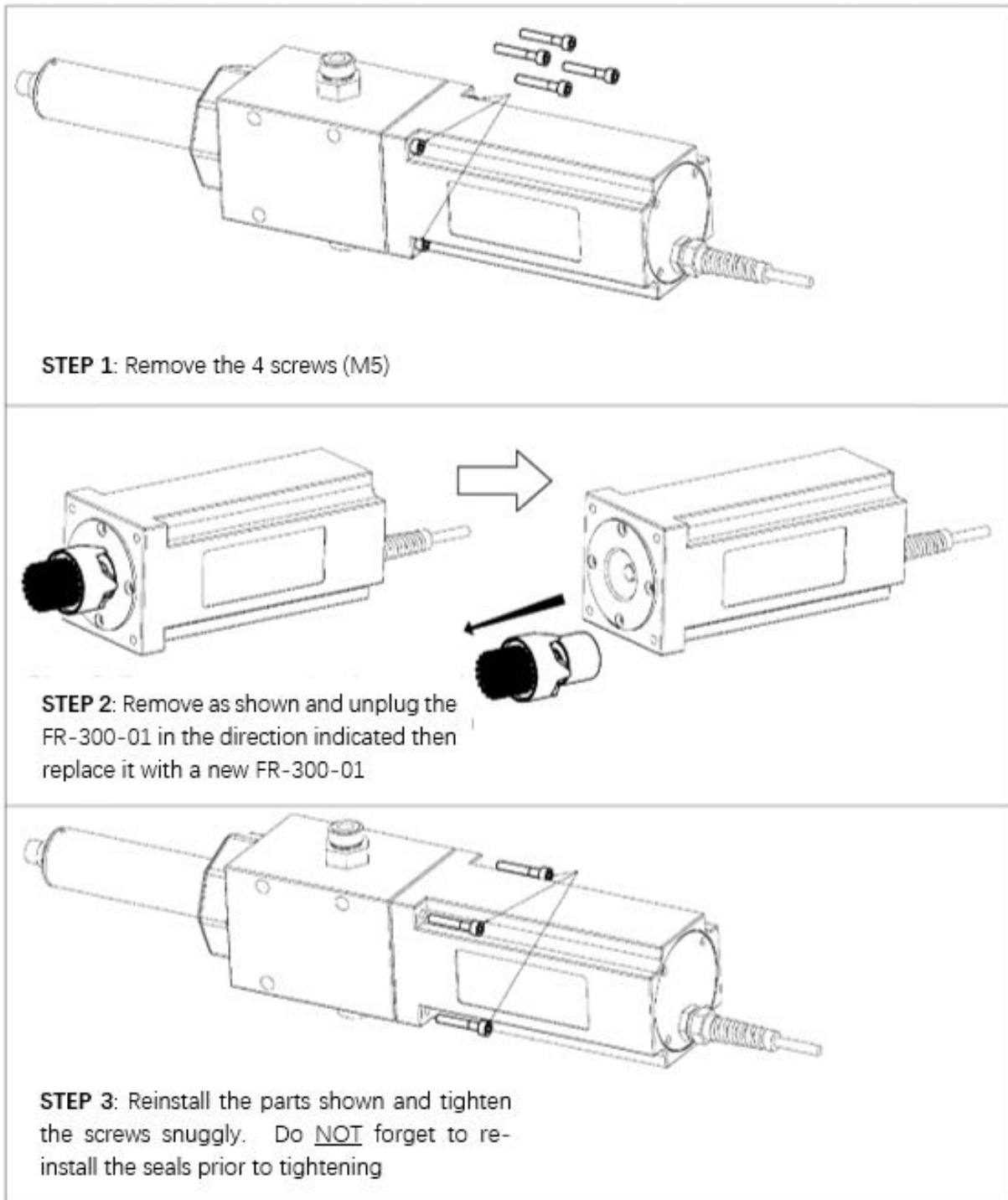

**STEP 1:** Remove the 4 screws (M5)

**STEP 2:** Remove as shown and unplug the FR-300-01 in the direction indicated then replace it with a new FR-300-01

**STEP 3:** Reinstall the parts shown and tighten the screws snugly. Do NOT forget to re-install the seals prior to tightening



## FR-300-PLUS Flow & Operation

**INLET-OUTLET FLOW REGULATION:** The FR-300-PLUS is mounted horizontally on the OxiPanel. The water sample supply should enter the bottom of the unit via inlet port (3/8-inch OD) as seen in image below. The outlet water flow should exit the top of the unit via the outlet port (3/8-inch OD). The inlet water pressure should not exceed 30 psi. The outlet water should be returned to open sump at atmospheric pressure. The range of flow through the FR-300-PLUS should be consistently regulated between 200 and 800mL/minute. An inlet rotameter may be installed to verify and regulate inlet flow however, this is not absolutely necessary and a manual flow verification test is sufficient as long as flow remains consistently regulated. **\*NOTE\*** *The FR-300-PLUS should be installed in a way to ensure the ST-765 series sensor remains flooded and wet regardless of flow condition.*

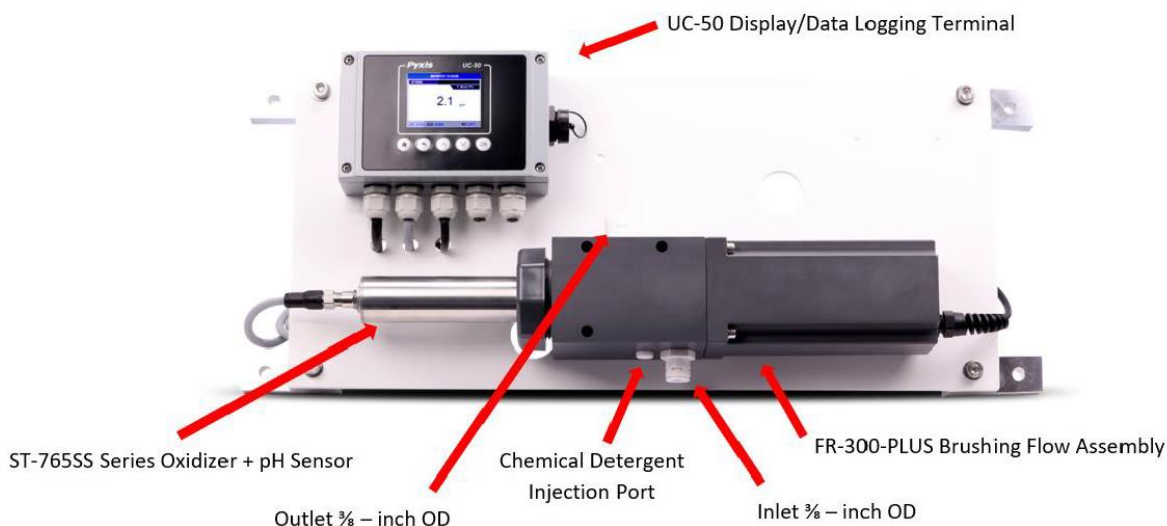

**FR-300-PLUS OPERATIONAL MODES:** The FR-300-PLUS is terminated to the UC-50 display via 7-pin waterproof communication/power cable powered via 24VDC with RS485 communication. The UC-50 display will come preprogrammed to operate 100% of the time with Manual ON/OFF control of the motorized brush as a default. This is the Pyxis suggested form of operation of the FR-300-PLUS and the sensor remains wet at all times regardless of operation. This may require special installation techniques to prevent water drainage from the FR-300-PLUS during no flow periods. Optional flow based ON/OFF operation of the FR-300-PLUS is available with the UC-50 as outlined in the section below.

**FLOW SWITCH ON/OFF BRUSH CONTROL:** The FR-300-PLUS has RS-485 connectivity to the UC-50 which allows for users to regulate ON/OFF condition based on a customer provided system flow switch signal from the operation. For those desiring to operate on a flow condition basis according to system operation the UC-50 display offers contact input signal control scenario based on the flow condition of the system operation. See [UC-50 SETUP OF USER DEFINED SIGNAL INPUT FEATURE](#) section for programming.

**SENSOR CALIBRATION:** Once proper flow has been established and regulated, an in-situ slope calibration of the sensor can should be conducted using field analysis of the sample being measured. (ie. DPD Free Chlorine) See sensor calibration section of this manual for detailed calibration instructions.

**UC-50 Display/Data Logger Dimensions (mm)**

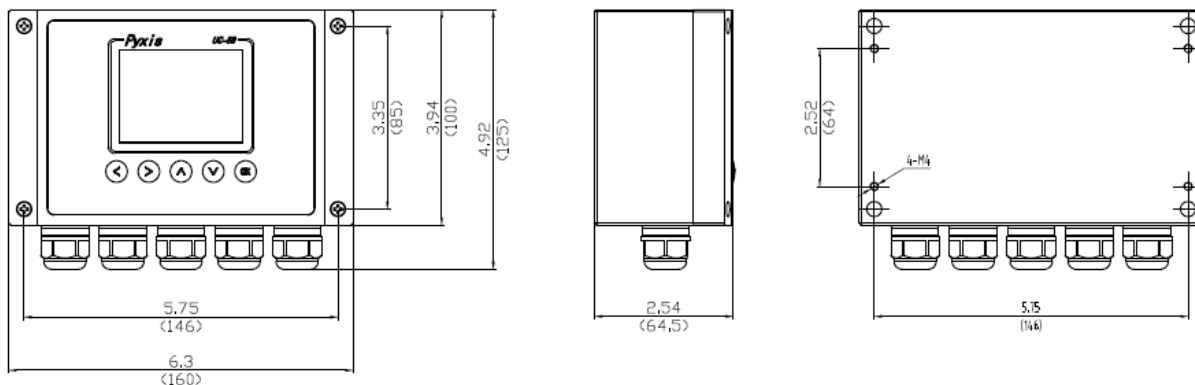

**ST-765SS Series Sensor Dimensions (mm)**

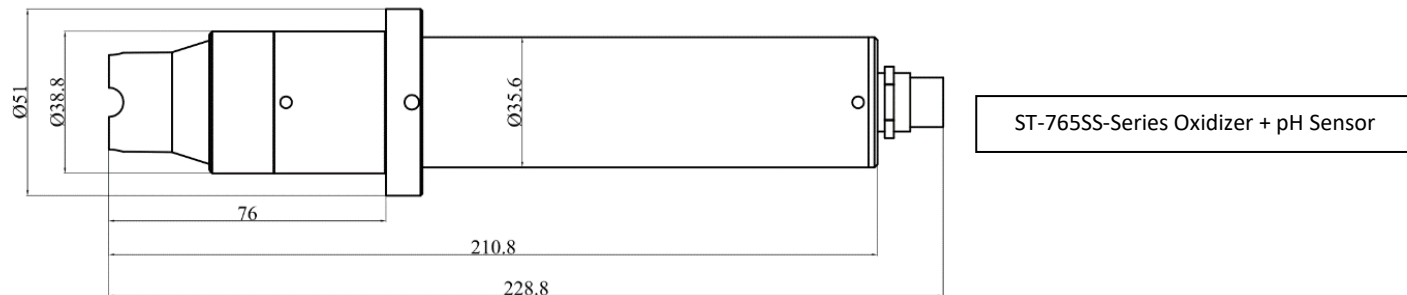





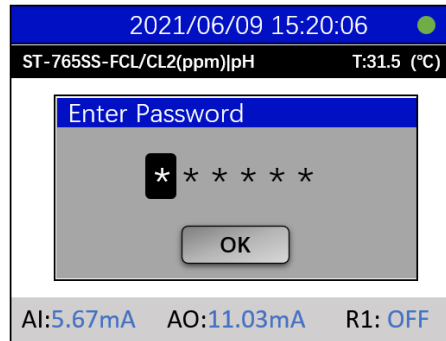



## UC-50 ACCESS PASSWORD

The password function prevents unauthorized personnel from improper operation. To access UC-50 setting menu, a user password must be entered. Only authorized personnel can calibrate and program the controller. Press  button from the main screen to show the password enter window. The cursor shows **Black** is the selection mode, and **blue** is the editing mode. Click the **OK** key to enter the editing mode, and the **up/down** keys can be used to adjust the value of the password item **\*NOTE\*** - **The initial password is 000000**



### Password Setting Procedure.



1. Navigate to **Password** screen:

*Main Screen*    *Enter Password*   or   *Password*  **OK**

Initial password >> 000000.

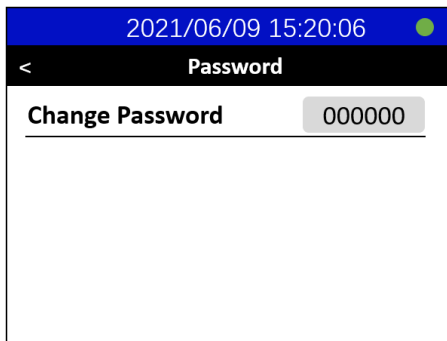
2. Press the **OK** button to show the password config window.



3. Press  or  keys to adjust the password values.
4. Once setting, Move the cursor to **OK** button to confirm the new password (as shown in figure above).

**\*NOTE\*** If you forget this password, Contact Pyxis for the administrator password.

## UC-50 TERMINAL BOARD WIRING DIAGRAM

Please refer to the wiring terminal diagram below for the UC-50 display/data logger. **NOTE** – the UC-50 terminal board provides two prewired 8-pin pigtail cables with adapters. The input cable offers a male adapter for direct connection to the ST-765SS Series sensor input. This cable is to be terminated to the sensor only.

The output pigtail offers a female adapter. This pigtail cable is designed to be connected to the loose flying lead cable with male adapter and open wires that is provided with the panel. This 8-pin output enables 2x 4-20mA signal passthrough and 1x RS-485 passthrough of the ST-765 Series sensor as well as one 4-20mA USER-DEFINED output from the UC-50 and 1x 24-VDC (10Watt) Relay output to pass onto another device. Output wiring details can be found in the next section of this manual

UC-50 display/data logger supports two types of inputs: Digital Input (Pulse or Electrical Level) or Analog Input(4-20mA), which can be converted via DIP switches on UC-50 internal AI/DI module. See [UC-50 SETUP OF USER DEFINED SIGNAL INPUT FEATURE](#) section for more details.

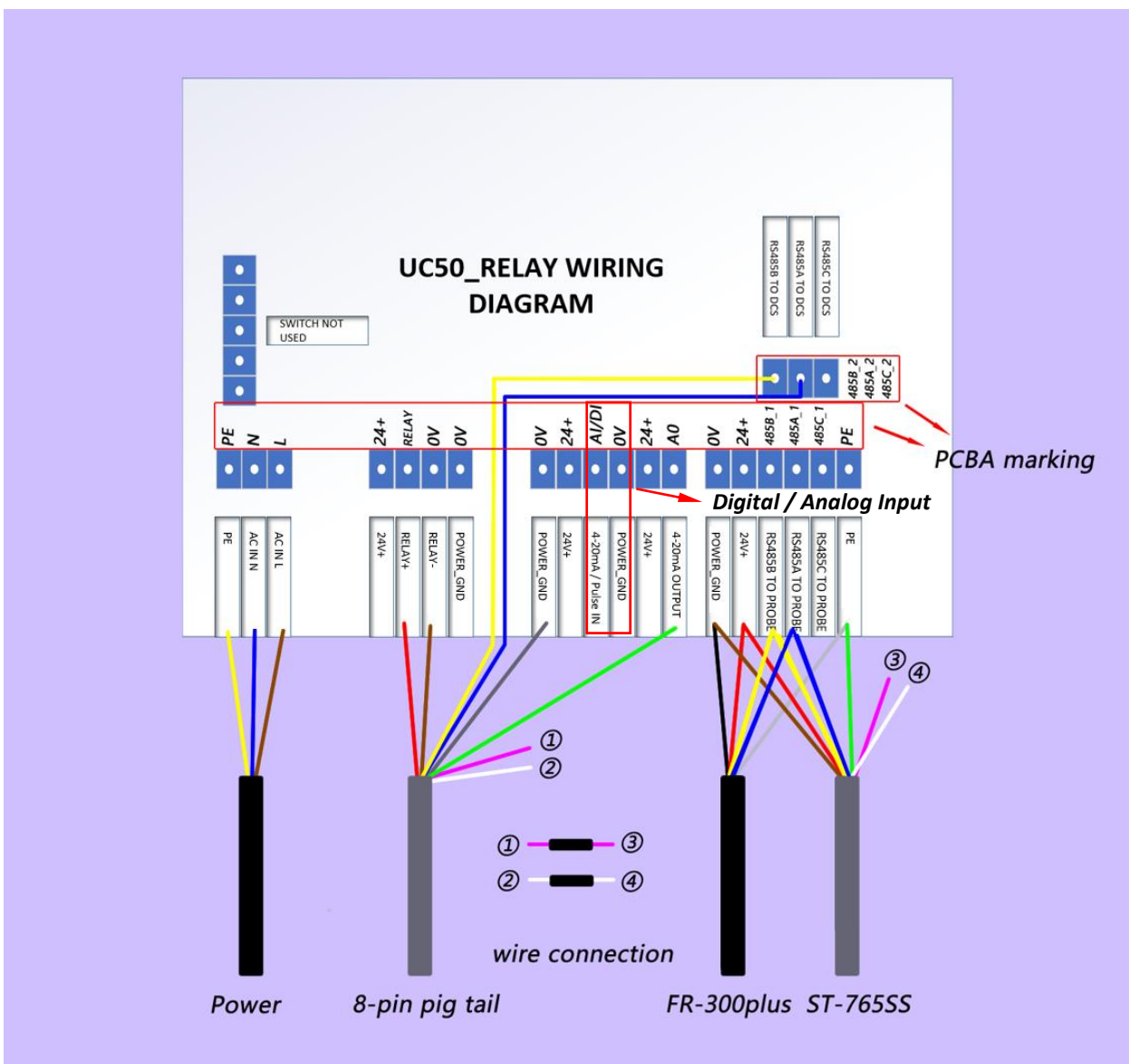

### UC-50 OUTPUT SIGNAL/RELAY WIRING DETAILS AND 4-20mA RANGES

As mentioned in the previous section, the UC-50 internal terminal board is prewired with two 8-pin cable pigtail cables. The input cable (male adapter) is to be terminated the ST-765SS series sensor. The output cable (female adapter) is to be terminated to the loose flying lead cable provided with the panel and allows 2x 4-20mA output signals and 1x RS-485 signal of the ST-765SS Series sensor to be PASSED-THROUGH to another receiving device in addition to 1x 4-20mA USER DEFINED output from the UC-50 (referred to as AOut in UC-50 dropdown list). Additionally, the prewired 8-pin output cable offers a 24VDC (10Watt) relay for operation of alarm, light, buzzer or other device based on the user relay settings in the UC-50 itself.

The flying lead section of the loose shipped output cable may then be landed to the input terminal of "ANOTHER DEVICE". This passthrough of the 2x 4-20mA signals and 1x RS-485 signal directly from the ST765 series sensor (pH + Oxidant), as well as the 1x user defined UC-50 4-20mA output and 1x 24VDC Relay for use as desired. Please refer to the wiring table below for proper wiring of 8-pin output cable provided with each UC-50.

Output Wire-Color	Designation
Red	Relay+
Brown	Relay-
Blue	485A
Yellow	485B
Pink	4-20mA+ for pH
Gray	4-20mA-
White	4-20mA+ for Oxidizer
Green	4-20mA+ from UC-50 User Assigned <i>serial # 220018 and after</i>

ST-765SS Series Sensor Signal Pass-Through From UC-50		
Unit of Measure	4mA Value	20mA Value
pH	0.00 pH	14.00 pH
Oxidizer (FCL / CLO2 / Br)	0.00 ppm	5.00 ppm
Oxidizer( DBNPA)	0.00 ppm	20.00 ppm
UC-50 Analog Output	User Defined	User Defined



## START-UP PROCEDURE

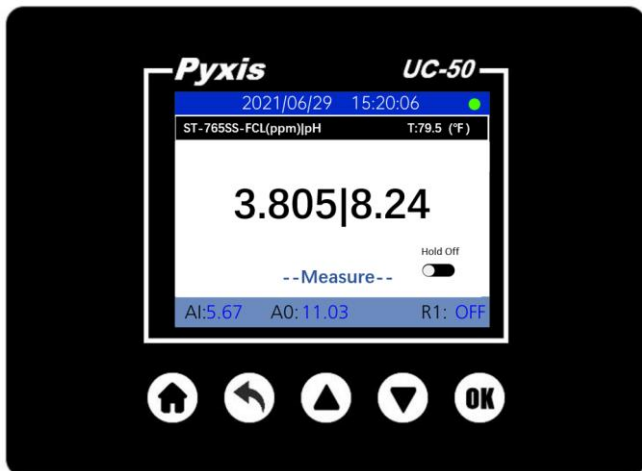

- Home key** -Return to the main screen from any interface
- Back key** -Return to the last displayed screen or open the setting menu from the main interface
- Up key** -Select different settings or adjust parameters
- Down key** -Select different settings or adjust parameter
- OK key** -Confirm to enter a settings page or confirm parameters

Click the back key on the main interface, UC-50 will display the setting interface. ALL probe-related settings and UC-50 settings can be selected on this page. If you need to connect a new probe, please select the probe settings and then click the ok key button to enter the probe setting page.

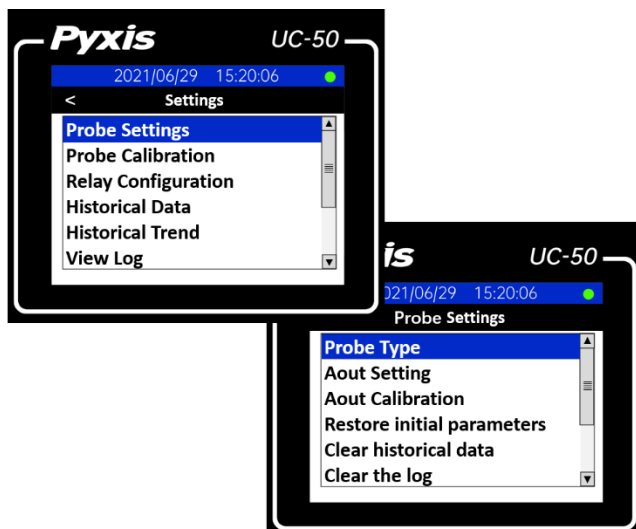

The UC-50 is preset to be connected to the ST-765SS series probe when it leaves the factory. After the UC-50 is turned on, the main interface of the UC-50 will display the Oxidizer concentration, pH value and temperature of the tested solution. The green dot in the upper right corner of the UC-50 main interface indicates that the UC-50 is operating normally. If used, the 4-20mA input signal, 4-20mA output signal and relay output states are displayed at the bottom of the UC-50 main interface.

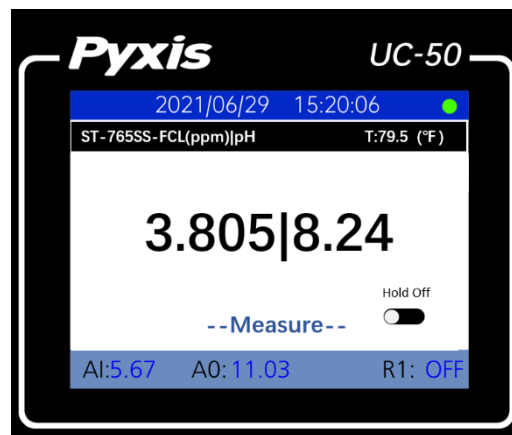

UC-50 controller supports manual selection of the probe type or automatic identification of the probe type. Please use the up/downs keys to select the correct probe type or select Auto Discover.

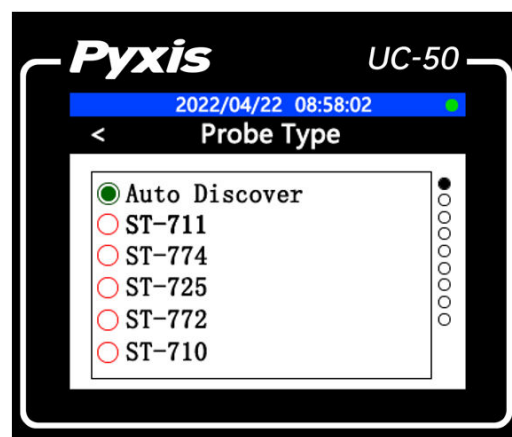

## SETTING DATE & TIME ON UC-50 DISPLAY

From the **system information screen**, use the ▼ button to highlight the **Time** field (highlighted field is black), then press **OK** for editing (edit mode is blue), press the ▲ or ▼ until the desired value is selected. Once setting, Hit the **OK** Key to confirm the new desired value.

2023/01/06 10:29:02	
<b>&lt; System Information</b>	
Serial Number:	200001
Hardware Version:	1.0
Software Version:	1.0r487
Time	2023 / 01 / 06 10:29:27
Language:	English
CPU:3%	MEM:46%

## TEMPERATURE UNIT of MEASURE SETUP PROCEDURE

The display unit of temperature is Celsius by default. Users can switch the temperature unit as desired in **Temp Units** notification box. From the **Main Menu**, select **Temp Units**. Here you may alter between desired unit of measure for the analog output scale.

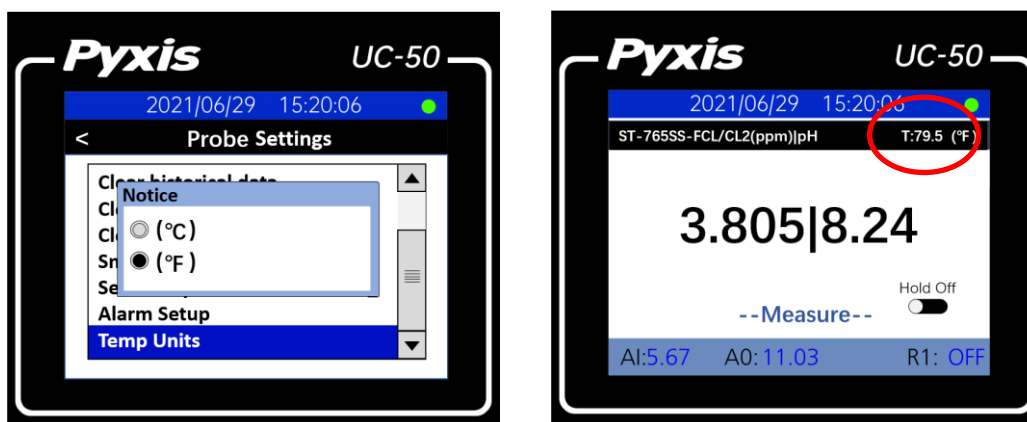

Return to the **Home** page by pressing . On the Home page the temperature reading will be displayed in the upper right corner of the screen in the units of measure selected.

## UC-50 SETUP OF USER DEFINED SIGNAL INPUT FEATURE

The UC-50 supports two types of inputs starting with serial # 230143 and after: **Digital Input** (Pulse or Electrical Level) or **Analog Input**(4-20mA), which can be converted via DIP switches on UC-50 internal AI/DI module. Please use tweezers to turn the specified DIP switch to “ON”.

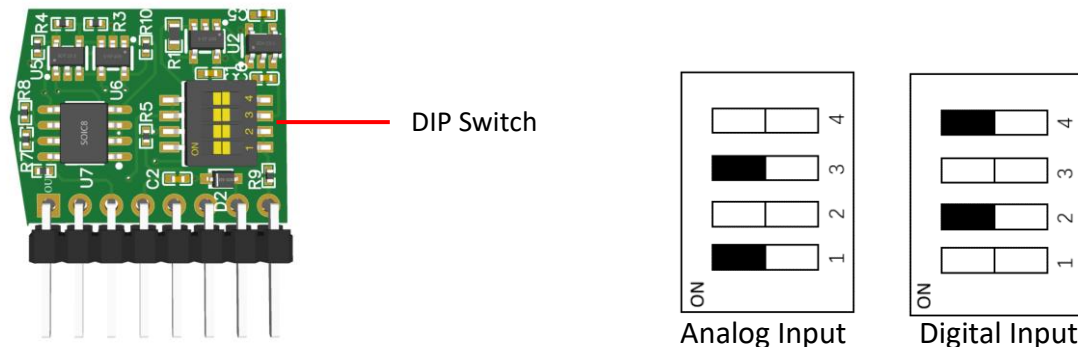

- Turn **DIP1** and **DIP3** to “ON” to configure as **AI** input mode(default).
- Turn **DIP2** and **DIP4** to “ON” to configure as **DI** input mode.

After completing hardware configuration, Users should select the **Input settings** interface of the UC-50 then click on the **Input Type** option to select the type of Input signal.

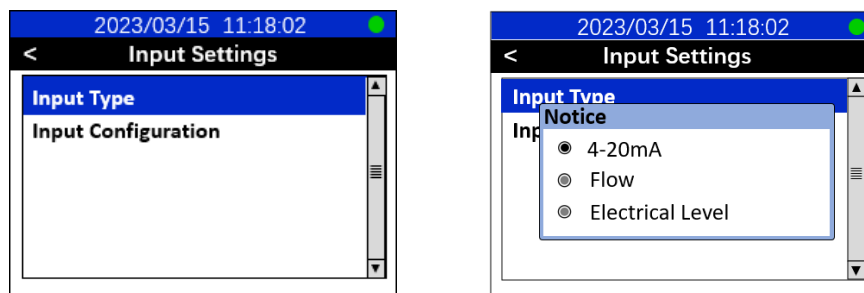

### Descriptions of UC-50 Input Signal.

Option	Input Type	Recommended Input Source
4-20mA	Analog Signal	Sensor with 4-20 output
Flow	Digital Signal	Flowmeter with pulse output
Electrical Level	Digital Signal	Rotameter

- If **4-20mA** from the **Input Type** window is selected, users do not need to perform **Input Configuration**. The 4-20mA input value will be displayed in the lower left corner of the main page. e.g., AI: 4.29mA.
- If **Flow** from the **Input Type** window is selected, users need to calibrate the flowmeter to convert the pulse signal into the correct flow value.



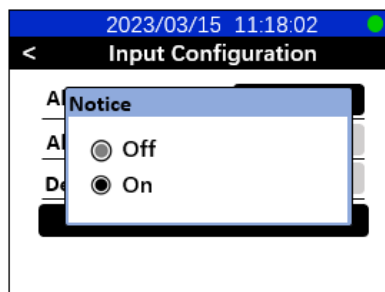
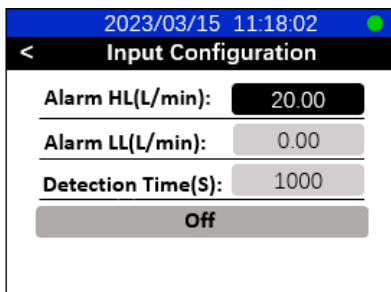

Users can also enable the alarm function in **Input Configuration** interface. The **Upper Alarm (Alarm HL)** and **Lower Alarm (Alarm LL) limit** are constantly compared with flow rate value. Once the flow rate value exceeds the alarm upper limit or falls below the alarm lower limit, and the duration time is longer than the user programmed detection time, the flow rate value will turn red. e.g., **DI: 25mL/min▲**.

- If **Electrical Level** from the **Input Type** window is selected, users need to set turn off conditions of the FR-300-PLUS brush in the **Input Configuration** page. The electrical input level will be displayed in the lower left corner of the main page. e.g., **DI: ▲**.
  - a. ▲ Turn off the FR-300-PLUS when the rotameter outputs high level, otherwise turn on.
  - b. ▼ Turn off the FR-300-PLUS when the rotameter outputs low level, otherwise turn on.

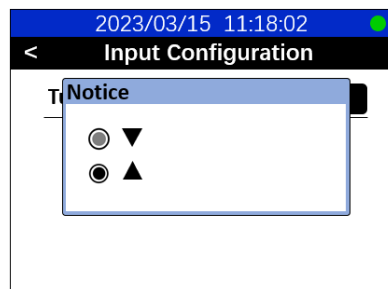
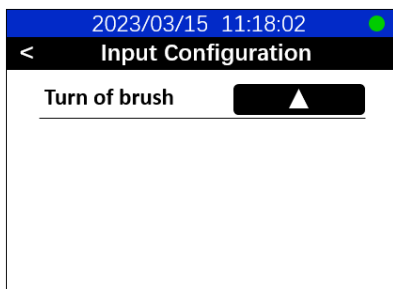

## UC-50 SETUP OF USER DEFINED ANALOG OUTPUT FEATURE

UC-50 display/data logger supports one extra 4-20mA output of any sensor measurement parameter to be user defined for units with serial # 220018 and after. This will be programmed for Temperature as a default from the Pyxis factory and referred to in the previous section this output is internally connected to the green wire of 8-pin output pigtail table. Users can select the **AOut** setting interface of the UC-50 then click on the **Parameter** option to select the ST-765SS Series probe measurement parameters and alter the A-Out as desired.

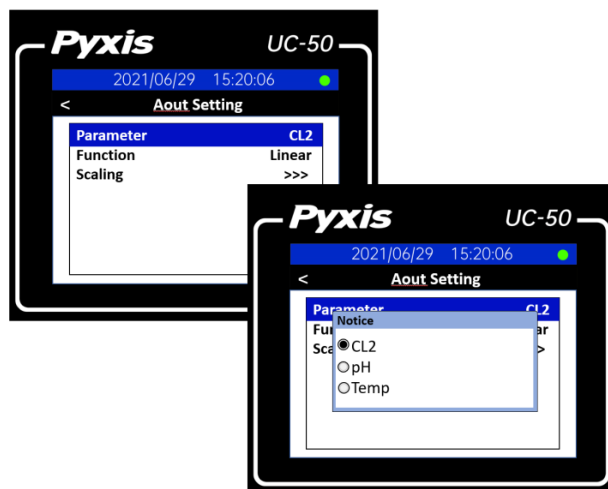

Click **Scaling** option to enter the 4-20mA span interface. You can change the Oxidizer, pH or Temperature value corresponding to the 20mA output to the same or lower default value as seen in the figure below. Click the **OK** button when complete.

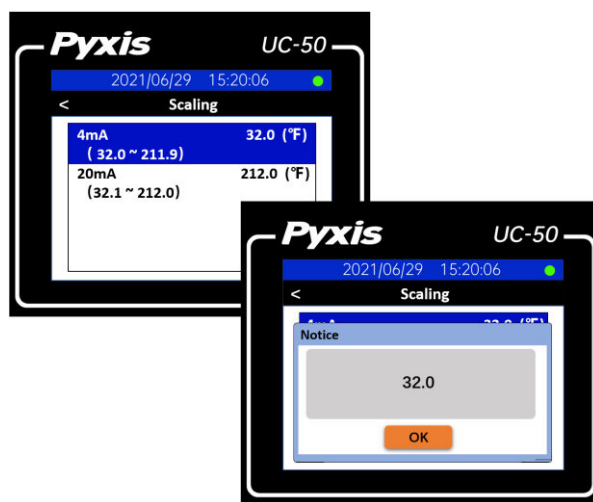

UC-50 Analog Output 4-20mA Range of Measurement		
Unit of Measure	4mA Value	20mA Value
pH	0.00 pH	14.00 pH
Oxidizer (FCL / CLO2 / Br)	0.00 ppm	5.00 ppm
Oxidizer (DBNPA)	0.00 ppm	20.00 ppm
Temperature (°C / °F)	0.0 °C / 32.0 °F	100.0 °C / 212.0 °F

## UC-50 RELAY CONFIGURATION

The UC-50 is equipped with relay output (24V, 8w) which is designed for alarm relay activation or may be used as desired. The UC-50 relay offers 5 modes of operation. The number of adjustable parameters will differ depending on the mode the user selects.

### 1. DISABLE RELAY MODE

When setting [**Disable**] mode, the relay does not accept any functions or allow any actions.

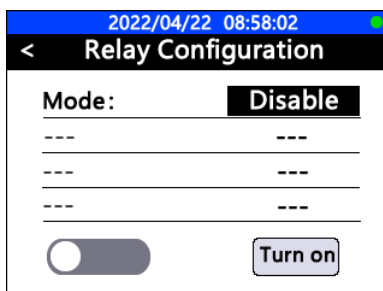

### 2. MANUAL RELAY MODE

When setting [**Manual**] mode, you need to press ▼ to move the cursor to the button, then press **OK** to turn on the relay manually. You will note the “Turn OFF” button activated at bottom of page when in Manual Mode with a GREEN color coded button to left indicating the relay is currently ON. When pressing the “Turn OFF” button, you will deactivate relay. Press again to activate.

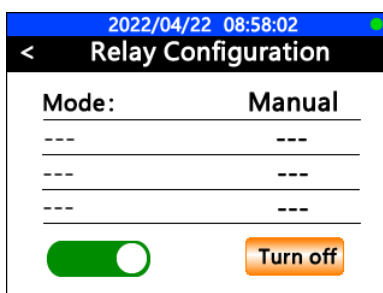

### 3. TIME RELAY MODE

When setting [**Time**] mode, the relay will repeat the activation metering according to the timing period (hr) and hold time (min) programmed by the user. EXAMPLE - The Parameters displayed below represent the relay turning on every 24 hours, for a duration of 60 minutes.

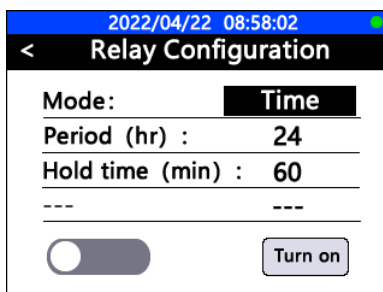

#### 4. ALARM (LL) or ALARM (HL) MODES

The **Turn ON** and **Turn OFF threshold** values are constantly compared with the primary measurement of the sensor. In the case of OxiPanel, the primary measurement is oxidizer (ie. Free Chlorine)

**Security time** is used to set the activation time of the relay in a range of 0 ~ 99999 seconds. If user does not want to limit the activation time of the relay, the **security time** should be set to " 0 ".

- In **Alarm LL** (Alarm Low Limit) mode, once the measurement value falls below the **Turn ON threshold value**, the UC-50 will turn the relay on. Once the measurement value exceeds the **Turn OFF threshold**, the UC-50 will turn the relay off.
- In **Alarm HL** (Alarm High Limit) mode, once the measurement value exceeds the **Turn ON threshold value**, the UC-50 will turn the relay on. Once the measurement value falls below the **Turn OFF threshold**, the UC-50 will turn the relay off.

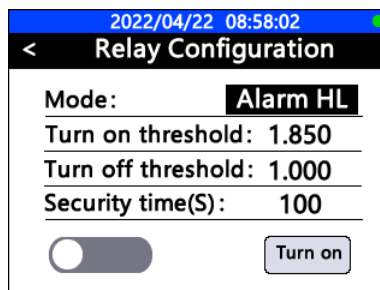
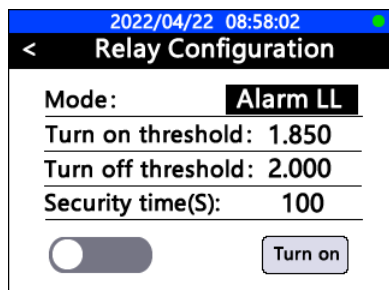

**\*NOTE\*** - If the user program security time has been reached but the alarm Lower limit or alarm higher limit have not been met, the UC-50 main screen measurement values will turn **RED**.



## ZERO OXIDIZER - CALIBRATION PROCEDURE

**\*NOTE\*** Under normal circumstances, the ZERO calibration of the ST-765 series sensor is not recommended or required. Pyxis Lab suggests SLOPE calibration only, unless otherwise directed via Pyxis Lab technical support team. Please refer to the SLOPE calibration procedure section for details.

Select the **Probe Calibration** in the setting menu to enter the ST-765SS probe calibration interface as shown in the figure below. Use the up and down keys to select 5 calibration types. First put the probe into the zero-oxidizer standard solution (Pyxis PN: 20022) or 100us/cm conductivity standard is also acceptable for zero standard solution. After the probe reading is stable for at least 10 minutes, select **Zero Cal** and click the OK button to start the zero calibration.

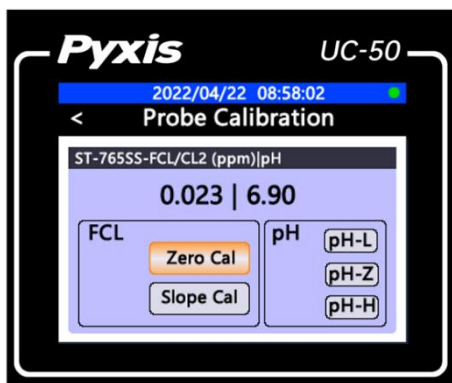

Select the OK button on the probe calibration confirmation page. The UC-50 controller sends the **Zero calibration** command to the ST-765SS probe and waits for the probe calibration result. The probe calibration result will be automatically displayed on the calibration interface.

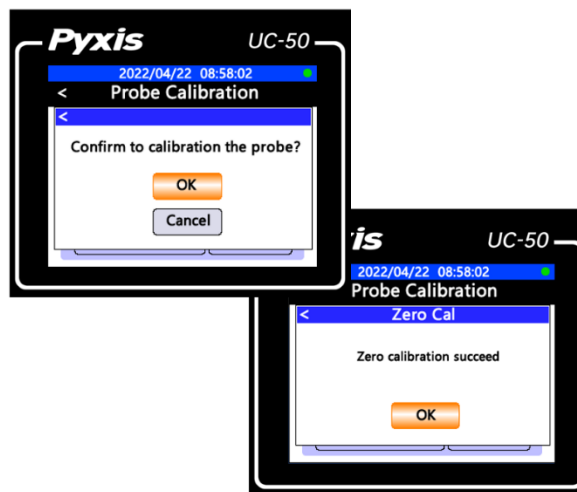

## SLOPE OXIDIZER -CALIBRATION PROCEDURE

**Slope calibration** should be selected on the Probe Calibration page. While the sensor is exposed to active flow of 200-800mL/min in the FR-300 plus flow reservoir. Enter the Free Chlorine, Bromine or Chlorine Dioxide concentration determined by the DPD method and ensure that probe reading has been stable for at least 10 minutes, select **Slope Cal** and click the OK button to start the slope calibration.

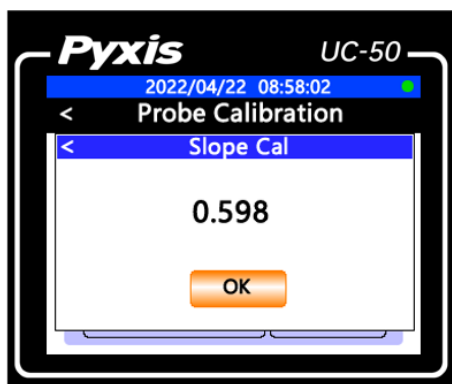

Select the OK button on the probe calibration confirmation page. The UC-50 controller sends the **Slope calibration** command to the ST-765SS probe and waits for the probe calibration result. The probe calibration result will be automatically displayed on the calibration interface.

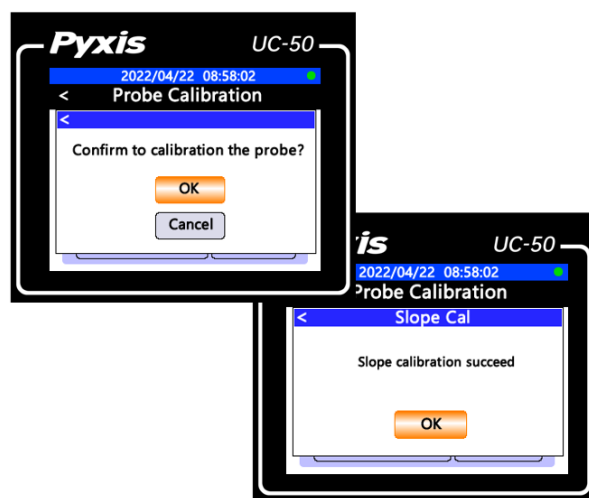

**\*NOTE\*** The ST-765SS Series must be slope calibrated in the FR-300-PLUS flow reservoir provided with the sensor and have consistent flow.

### pH LOW – CALIBRATION PROCEDURE

pH-L calibration should be selected on the **Probe Calibration** page. Remove and place the ST-765SS Series probe in the pH4.0 standard solution, measure for 1 minute and wait for the measurement result to stabilize. Click the Ok button to start the pH-L calibration.

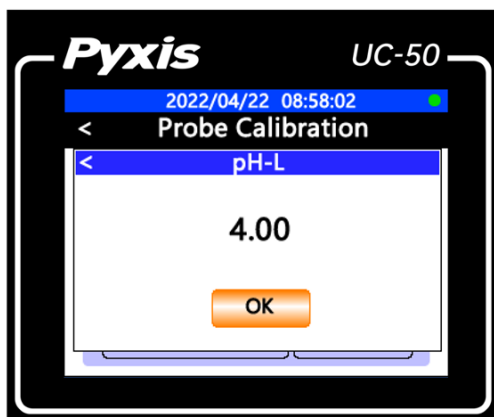

Select the OK button on the probe Calibration confirmation page. The UC-50 controller sends the pH-L calibration command to the ST-765SS probe and waits for the probe calibration result. The probe calibration result will be automatically displayed on the calibration interface.

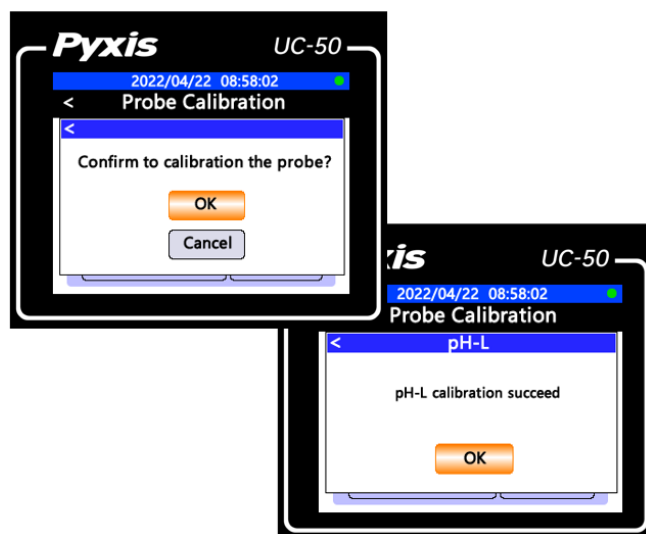

### pH MID(Z) - CALIBRATION PROCEDURE

pH-Z calibration should be selected on the **Probe Calibration** page. Remove and place the ST-765SS Series probe in the pH7.0 standard solution, measure for 1 minute and wait for the measurement result to stabilize. Click the Ok button to start the pH-Z calibration.

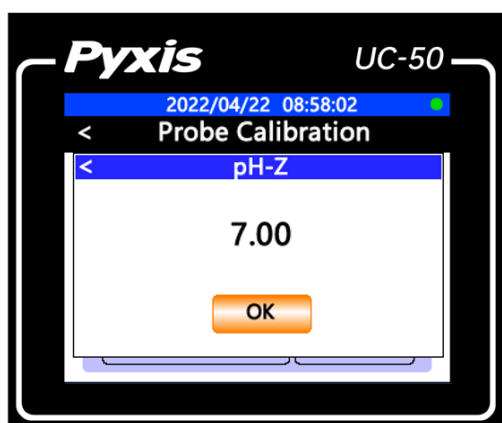

Select the OK button on the probe Calibration confirmation page. The UC-50 controller sends the pH-Z calibration command to the ST-765SS probe and waits for the probe calibration result. The probe calibration result will be automatically displayed on the calibration interface.

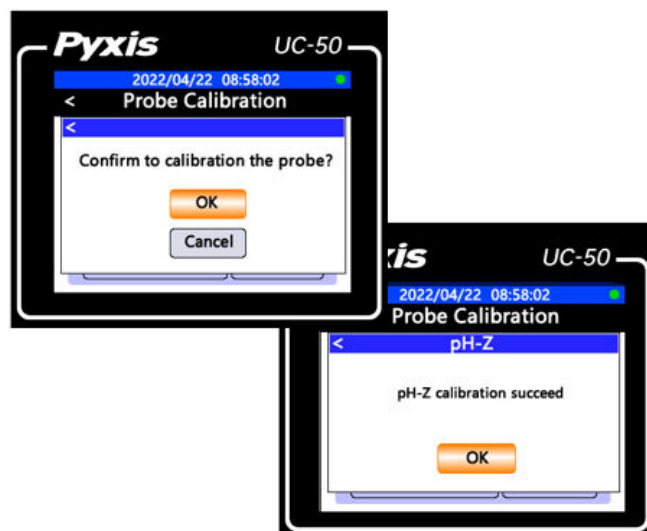

## pH HIGH - CALIBRATION PROCEDURE

pH-H calibration should be selected on the **Probe Calibration** page. Remove and place the ST-765SS Series probe in the pH10.0 standard solution, measure for 1 minute and wait for the measurement result to stabilize. Click the Ok button to start the pH-H calibration.

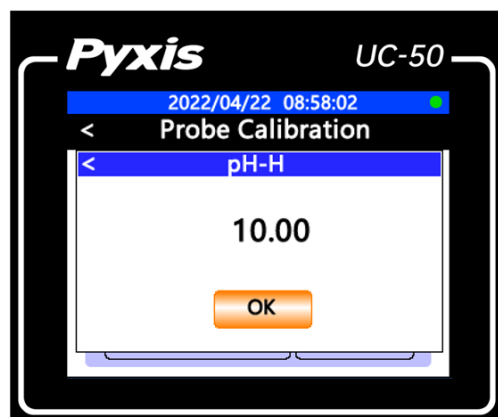

Select the OK button on the **Probe Calibration** page. The UC-50 controller sends the pH-H calibration command to the ST-765SS probe and waits for the probe calibration result. The probe calibration result will be automatically displayed on the calibration interface.

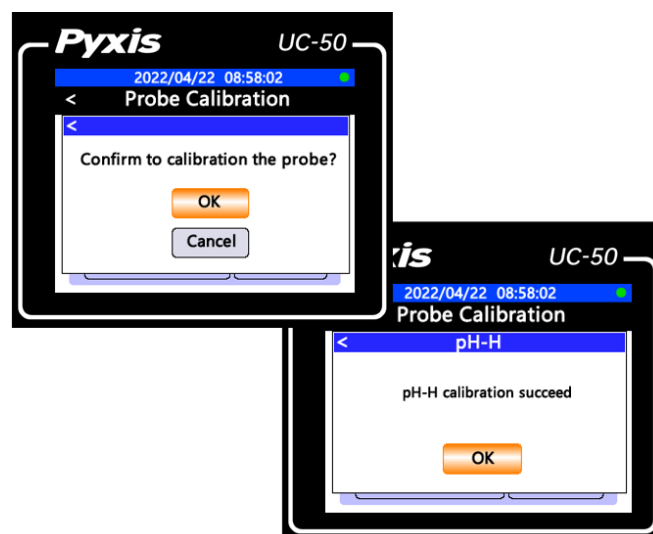

## HISTORICAL DATA & TRENDING

Select **Historical Data** on the setting interface of the UC-50 controller. You can view the stored historical measurement data of ST-765SS. UC-50 controller stores measurement data of ST-765SS every 1 minute. This time period may be adjusted if desired. You can browse the data of different time periods with the up and down keys. The data types from left to right are Oxidizer concentration, pH, temperature and 4-20mA input value.

2022/04/22 08:58:02	
< Historical Data	
Time	---
2022/04/25 14:47	2.548/7.014/26.387/0.224
2022/04/25 14:46	2.529/7.001/26.387/0.225
2022/04/25 14:45	2.518/7.025/26.387/0.223
2022/04/25 14:44	2.506/7.015/26.387/0.223
2022/04/25 14:43	2.486/7.016/26.387/0.215
2022/04/25 14:42	2.481/7.026/26.387/0.220
2022/04/25 14:41	2.475/7.014/26.324/0.224
2022/04/25 14:40	2.468/7.016/26.324/0.224
2022/04/25 14:39	2.450/7.020/26.324/0.222
2022/04/25 14:38	2.429/7.015/26.324/0.219

Select **Historical Trend** on the setting interface of the UC-50 controller. You can view the historical measurement data saved by the UC-50 controller in the form of a trend graph. Use the up and down keys and the confirm key to select to view the data of the last day, week or month.

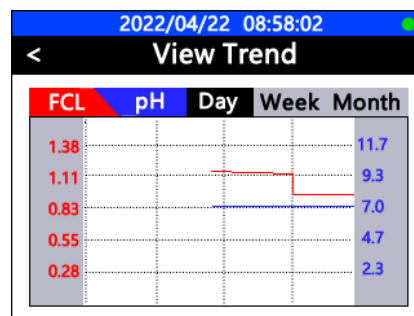



## RESTORING FACTORY PARAMETERS & PROBE DIAGNOSIS

If the abnormal reading of the probe is caused by improper calibration, you can select the **Restore initial parameters function** in the probe setting interface of the UC-50 controller to restore the internal parameters of the ST-765SS probe to the factory parameters.

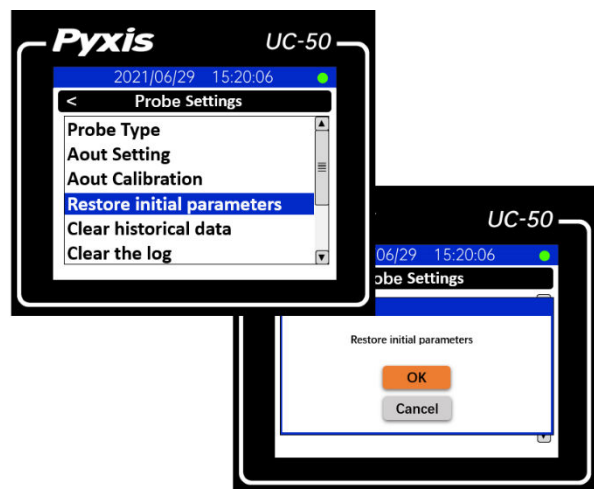

The UC-50 controller supports displaying the original diagnostic data of the ST-765SS. To help troubleshooting possible issues with the probe, please save images of these data when the probe is respectively placed in a clean water (tap water), in a sample water or pH standard solutions. Email the images to [service@pyxis-lab.com](mailto:service@pyxis-lab.com) for technical support. Selecting the Probe Diagnosis in the setting interface of UC-50 controller will display the internal original diagnosis data interface.

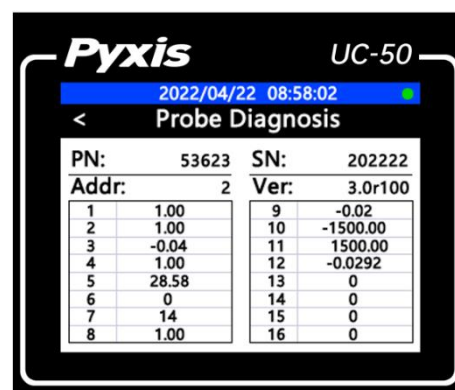

## USB FUNCTION FOR HISTORICAL DATA UPLOAD AND FREQUENCY

UC-50 has a built-in USB interface to support historical data export and firmware upgrade function. Before accessing USB functions, please make sure USB thumb drive is properly plugged into UC-50 USB interface.

**For data download and upload to the UC-50 a USB device with a storage capacity between 8 and 64MB \*Megabytes\* is recommended.**

### EXPORT UC-50 HISTORICAL DATA

Select USB Settings from the Settings screen. In the USB settings screen, historical data can be downloaded to a USB thumb driver by selecting Data Export function. Make sure a USB thumb drive is plugged into UC-50 before exporting historical data.

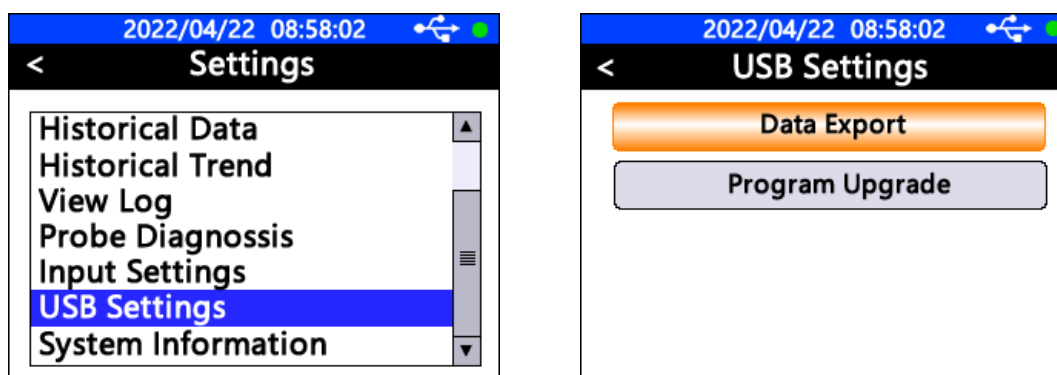

Further select the historical data date and time range or simply choose All Export to export all historical data. Once data export 100% completed, you can safely unplug the USB thumb drive. **\*NOTE\*** the date range for data upload should not exceed 12 months, otherwise, all data must be exported.

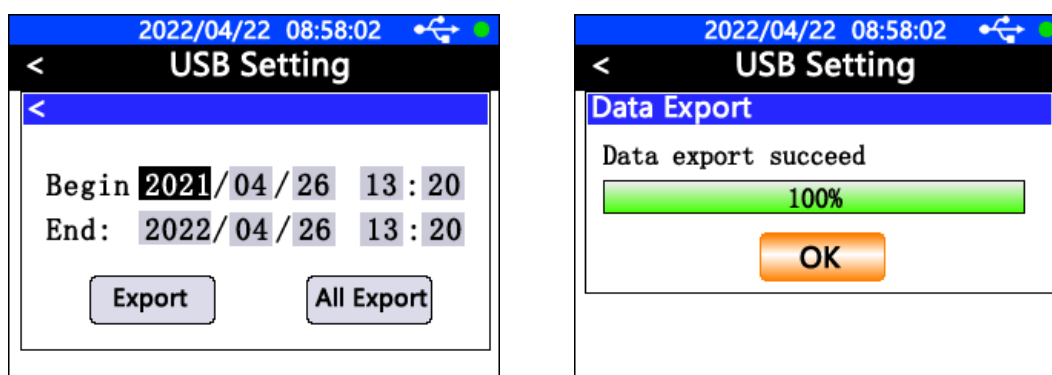

## ADJUST UC-50 HISTORICAL DATA LOG INTERVAL

By default, UC-50 will save sensor value every 60 seconds to its internal data storage, if an application requires 3 months historical data export, UC-50 will generate over 10,000 lines of historical data if the historical data interval is set to 60 seconds. However, UC-50 allows customer to adjust historical data interval to

- 1) Reduce exported historical data file size if high resolution data is not required.
- 2) Capture high resolution data if sensor value changes rapidly.

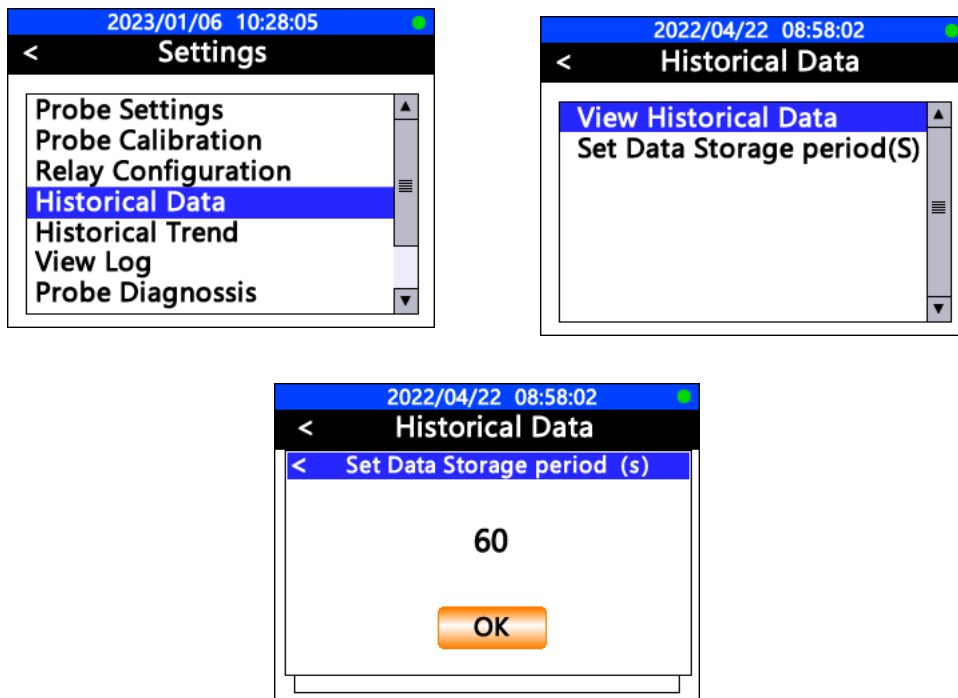

## UPGRADE UC-50 FIRMWARE

Copy the target UC-50 firmware file (.bin) to the root directory of USB thumb drive, plug the thumb drive to UC-50 USB interface, select **USB Settings** in Settings page and select Program Upgrade function in USB Settings page. UC-50 will automatically start firmware upgrading procedure and reboot itself once the procedure completed.

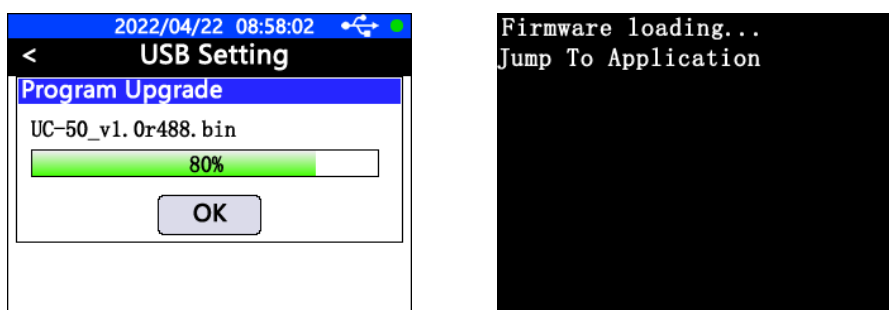

## EXPLANATION & USE OF THE SIGNAL HOLD FEATURE

The signal **HOLD - ON/OFF** feature is a function used to set and maintain the sensor output signal data at a constant value during periods when the sensor is not stable and/or fluctuating significantly due to maintenance and calibration. Maintaining a user set output signal from the IK-765 Series panel allows the sensor to be removed and/or maintained while preventing out of compliance network alarms possibly interrupting process operation. When activated, the HOLD feature allows the user to set and retain the output signal for both sensor parameters for a period of 15 minutes, after which the unit returns to normal operation and live reading output value.

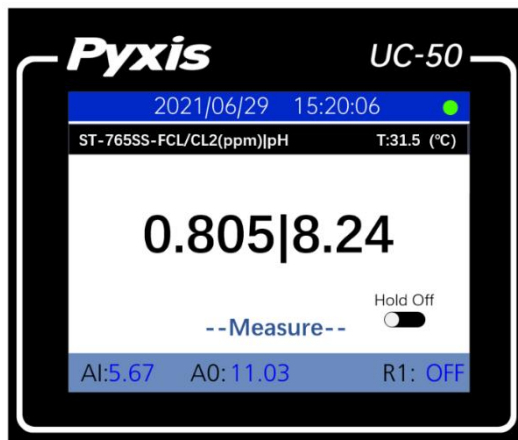

Long press **OK** button for 3 seconds on the main interface to open the **HOLD - ON/OFF** page. The cursor shows **black** is the selection mode, and **blue** is the editing mode. Click the **OK** key to enter the editing mode, and the **up/down** keys can be used to adjust the value of the setting item. Once set where desired, click the **OK** button to start the **HOLD-ON** function.

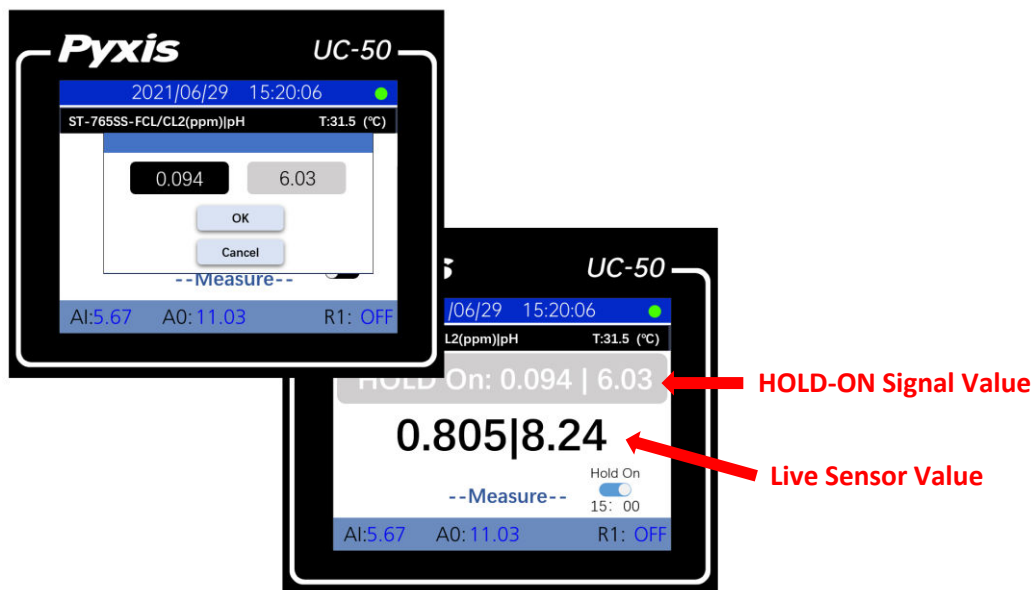

**UC-50 MODBUS RTU SLAVE STATION COMMUNICATION PARAMETERS**

UC-50 Default Communication Parameters	
Device Address	20
Baud Rate	9600
Word Length	8
Parity	None
Stop Bits	1

UC-50 Default Communication Parameters – (Writeable)			
Register Address	Type	Byte Order	Register Definition
42001	Unsigned int 16	AB	Device Address
42003	Unsigned int 16	AB	Parity 0=None Parity 1=Odd Parity 2=Even
42004-42005	Unsigned int 16	CDAB	Baud Rate

UC-50 Register Address of Measured Parameters – (Read-Only)			
Register address	Type	Byte order	Register definition
46001-46002	float	CDAB	Oxidizer
46003-46004	float	CDAB	pH
46005-46006	float	CDAB	Temperature
46007-46008	float	CDAB	4-20mA input

**\*NOTE\*** If the base address is 1, such as PLC system, access directly according to the register address. If the base address is 0 system, the register address is reduced by 1 after access.

## SENSOR CLEANING & MAINTENANCE

Most cleaning of the ST-765SS is facilitated by removing the sensor, rinsing it with tap or DI water and gently wiping the sensor head with a soft cloth or Q-tips, then re-rinse. For a highly fouled sensor, soak the lower half of the sensor in 100 mL Pyxis inline sensor cleaning solution for 10-15 minutes. Gently rub the sensor electrode head with the provided Q-tips. If the surface is not entirely clean, continue to soak the sensor for an additional time until clean. Rinse the sensor with distilled water. Pyxis Lab Inline Sensor Cleaning Solution can be purchased at our online Estore/Catalog at <https://pyxis-lab.com/product/probe-cleaning-kit/>



*ST-Series Probe Cleaning Kit (P/N SER-01)*

## COMMON SENSOR TROUBLESHOOTING

If the ST-765SS sensor output signal is not stable and fluctuates significantly, make an additional solution ground connection—connect the black ground wire to a conductor that contacts the sample water electrically such as a brass pipe adjacent to the ST-765

## REPLACING pH / OXIDIZER ELECTRODE HEAD

The pH/oxidizer electrode head of ST-765SS Series can be replaced when the original electrode head reaches its working life.

Order a replacement electrode head EH-765 (P/N 53061) from Pyxis and follow instructions as below.

1. Turn off the sensor if it is powered on.
2. Make sure there is no water on the sensor.
3. Hold the ST-765SS main body with one hand and use the other hand to twist the stainless-steel locking ring counter-clockwise until the front end of the black electrode is completely unscrewed, as shown in *Figure 2*.
4. Pull out the electrode head as shown in *Figure 3*.
5. Loosen the electrode plug connector, and remove the electrode head, as show in *Figure 4*.
6. To assemble the new electrode head, connect the plug, then insert the new electrode head into the main sensor housing and ensure that the two protrusions on the electrode head are aligned with the notches in the sensor main housing.
7. Then twist the stainless-steel lock ring of ST-765SS in a clockwise direction until the threads of the electrode head completely enter the ST-765SS housing as shown in *Figure 1*.

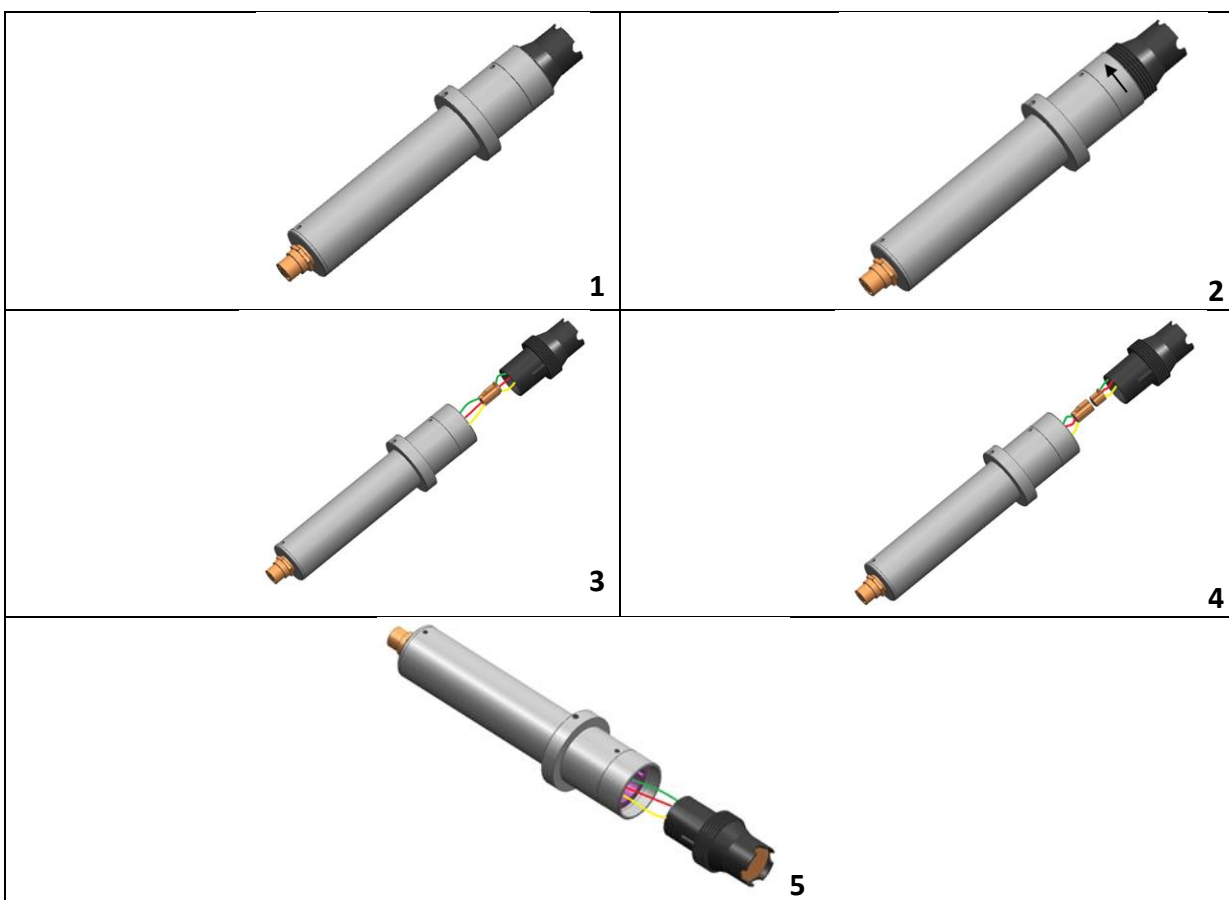

*Replacing EH-765 pH and Oxidizer Electrode Head*

**ORDER INFORMATION****Order Information**

	<b>P/N</b>
IK-765SS-FCL-B ( <i>Auto-Brushing Free Chlorine + pH + Temperature Analyzer</i> )	42169
IK-765SS-CLO-B ( <i>Auto-Brushing Chlorine Dioxide + pH + Temperature Analyzer</i> )	42170
IK-765SS-Br-B ( <i>Auto-Brushing Bromine + pH + Temperature Analyzer</i> )	44074
IK-765SS-DBNPA-B ( <i>Auto-Brushing DBNPA + pH + Temperature Analyzer</i> )	48361

**Optional / Replacement Accessories Information**

	<b>P/N</b>
ST-765SS-FCL ( <i>Free Chlorine + pH + Temperature Sensor w/Internal Compensation-Sensor Only</i> )	53607-NFR
ST-765SS-CLO ( <i>Chlorine Dioxide + pH + Temperature Sensor w/Internal Compensation-Sensor Only</i> )	53608-NFR
ST-765SS-Br ( <i>Bromine + pH + Temperature Sensor w/Internal Compensation-Sensor Only</i> )	59643
ST-765SS-DBNPA ( <i>DBNPA+ pH + Temperature Sensor w/Internal Compensation-Sensor Only</i> )	54267
EH-765 ( <i>Replacement Electrode Head for ST-765SS-Series Sensors</i> )	53061
FR-300-PLUS ( <i>Replacement FR-300+ Auto-Brushing Flow Assembly Replacement</i> )	50700-A44
FRP-300-01 ( <i>Replacement Brush Assembly for FR-300+</i> )	50700-A49
UC-50 Display + Data Logging Terminal ( <i>Replacement</i> )	43007
SP-200 OxiPocket™ ( <i>Pocket All-Oxidizing Disinfectants Colorimeter &amp; Fluorometer</i> )	50802
ST-SERIES PROBE CLEANING KIT	SER-01