

Pyxis®

OXIPANEL PLUS

OXIPANEL PLUS Industrial IK-765SS-NCL-BP

Monochloramine + pH + ORP + Temperature Analyzer for Cooling & Process Water Applications

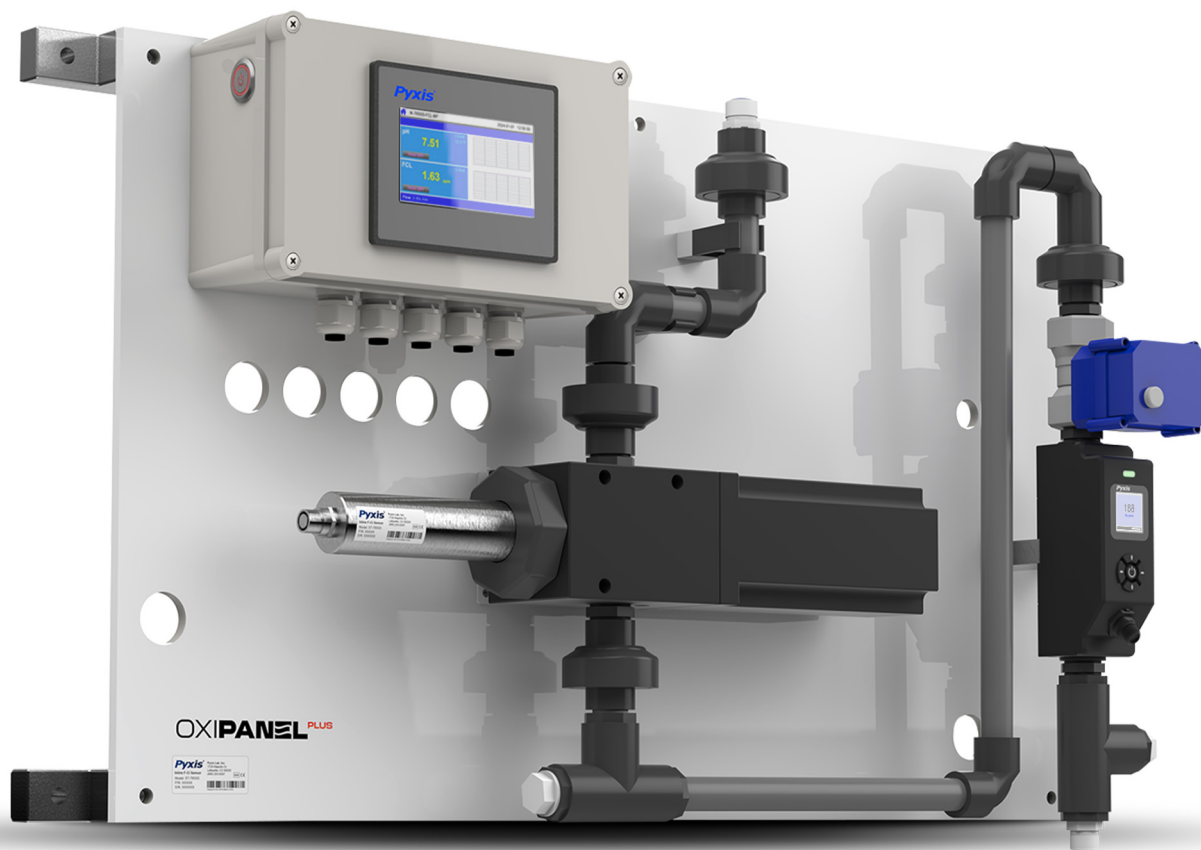

Pyxis Lab® Inc.
21242 Spell Circle
Tomball, TX 77375
www.pyxis-lab.com

USER
MANUAL

Related Statements

The manufacturer shall not be liable for direct, indirect, special, incidental or consequential damages resulting from any deficiency or omission in this manual. The manufacturer reserves the right to make changes to this manual and the products described in it at any time without notice or liability. Revised versions can be found on the manufacturer's website.

Safety Information

Please read this manual completely before unpacking, installing and operating this equipment. In particular, pay attention to all dangers, warnings and precautions, otherwise, it may cause serious personal injury to the operator or damage to the equipment.

Use of Danger Information

 Danger
Indicates a potentially or urgent dangerous situation that, if not avoided, will cause death or serious injury.



 Warning
Indicates a potentially or very dangerous situation that, if not avoided, may cause serious personal injury or death.

 Warning
Indicates a potentially dangerous situation that may cause a certain degree of personal injury.

Attention
Indicates conditions that if not avoided, will cause damage to the instrument. This is information that needs special emphasis.

Warning Label

Please read all labels and marks attached to the instrument. Failure to follow the instructions on these safety labels may result in personal injury or damage to the instrument.

	If this symbol appears in the instrument, it means refer to the operation and/or safety information in the instruction manual.
	If there is this mark on the instrument housing or insulator, it means there is a risk of electric shock or death from electric shock.
	Static electricity can damage the delicate internal electronic components, resulting in reduced performance or eventual failure of the instrument.

	<p>Electrical equipment marked with this symbol cannot be disposed of through the European public waste system after August 12, 2005. In order to comply with European regional and national regulations (EU Directive 2002 / 98 / EC), European electrical equipment users must now return abandoned or expired equipment to the manufacturer for disposal without any cost.</p>
---	---

Table of Contents

1.	Specifications	- 1 -
2.	Product Description	- 2 -
3.	Features	- 3 -
4.	Part Numbers & Ordering Details	- 4 -
5.	Analyzer Dimension and Mounting	- 5 -
6.	Analyzer Installation	- 5 -
6.1.	Installation Requirements	- 5 -
6.2.	Sample Water Connection	- 6 -
6.3.	Terminal Board Wiring	- 7 -
6.3.1.	<i>UC-80 Display Wiring Diagram</i>	<i>- 7 -</i>
6.3.2.	<i>UC-80 Display Pre-Wired Output Cable</i>	<i>- 9 -</i>
7.	Analyzer Components & Dimensions	- 10 -
7.1.	UC-80 Display & Data Logging Terminal (mm)	- 10 -
7.2.	FS-100 Ultrasonic Flow Meter (mm)	- 10 -
7.3.	FR-300-PLUS Automatic Brushing Flow Assembly (mm)	- 11 -
7.4.	ST-765SS Series Sensor (mm)	- 11 -
8.	FS-100 Flow Control Module Overview & Use	- 12 -
8.1.	FS-100 Key Function	- 12 -
8.2.	FS-100 Main Screen	- 13 -
8.3.	FS-100 Flow Trend Chart	- 13 -
8.4.	FS-100 - Setting the C-Mode for the Sample Flow Control	- 14 -
8.5.	FS-100 Modbus Communication Settings	- 15 -
8.6.	FS-100 Factory Reset	- 15 -
8.7.	FS-100 Device Information & Diagnosis	- 16 -
9.	UC-80 Display Touch Screen Operation	- 17 -
9.1.	Main Screen	- 17 -
9.2.	User Login & Password	- 17 -
9.3.	Real-Time Monitoring	- 18 -
9.4.	Activating the 4G DTU Gateway/Module	- 18 -

9.5.	Explanation and use of the Output Signal HOLD Feature	- 19 -
9.6.	Menu Bar	- 21 -
9.7.	Configurable Parameters	- 21 -
9.7.1.	<i>Control Interface</i>	- 22 -
	Flow Interlock Control	- 22 -
	Relay Output Control	- 23 -
9.7.2.	<i>Settings Interface</i>	- 26 -
	Alarm Parameters Setting	- 26 -
	Sensor Parameters - Smoothing Factor Description & Adjustment	- 26 -
9.7.3.	<i>User Defined Settings</i>	- 28 -
9.7.4.	<i>Diagnostic Parameters for Troubleshooting Support</i>	- 29 -
9.7.5.	<i>4-20mA Output Parameter Settings & Adjustment</i>	- 30 -
9.7.6.	<i>UC-80 Modbus Communication Settings</i>	- 31 -
9.8.	ST-765SS Series Sensor Calibration	- 31 -
9.8.1.	<i>pH Calibration</i>	- 32 -
9.8.2.	<i>Oxidizer Calibration</i>	- 34 -
9.8.3.	<i>ORP Calibration</i>	- 36 -
9.9.	Alarm View	- 36 -
9.10.	Historical Data – Query, View & USB Download	- 37 -
9.11.	Historical Data Curves	- 39 -
9.12.	User Management	- 40 -
10.	Modbus Register Table & Analyzer Maintenance	- 42 -
10.1.	Modbus Correspondence Address	- 42 -
10.2.	Analyzer Operation and Maintenance	- 43 -
10.3.	Instrument Alarms and Descriptions	- 43 -
11.	Replacement Maintenance	- 44 -
11.1.	Replacing the FR-300-PLUS Brush Assembly	- 44 -
11.2.	Replacing pH and Oxidizer Electrode Head	- 45 -
11.3.	Sensor Cleaning with Pyxis Probe Cleaning Kit	- 46 -

1. Specifications

Item	IK-765SS-NCL-BP
P/N	49348
Sensor Body Material	304SS
Sensor Model	ST-765SS-NCL
Oxidizer Measured	Monochloramine
Oxidizer Range	0.00-5.00 ppm
Oxidizer Precision	± 0.01mg/L or 1% /pH compensation up to 9.0
pH / ORP Range	0.00 -14.00 (± 0.01 pH) / -1,500 – +1,500 mV (± 1.0 mV ORP)
Measurement Interval	Continuous
Sensor Response Time	T95≤60s – Oxidant / T95≤5s - pH
Sensor Installation Method	FR-300-PLUS Magnetic Coupling Brushing Flow Reservoir Included
Sensor Flow Interlock	Sensor Powers Down when in Auto Mode if Flow <50mL/min and On when >200mL/min
Sample Operating Temperature	4 – 49°C (40 – 120°F)
Sample Inlet Operating Pressure	7.25 – 60 psi (0.05 – 0.413MPa)
Sample Inlet/Outlet Line Size	¾ - inch OD inserted into ½-inch FNPT port
FS-100 Method of Measure	Ultrasonic Flow Detection
FS-100 Rated Flow Range	0 – 3,000 mL/min
FS-100 Resolution/Max Error	1mL/min or ± 2% of the value
FS-100 Display	1.44" Color 128 x128 Resolution
Flow Regulating Valve Control Method	4-20mA from FS-100 (<i>internally connected</i>)
FR-300-PLUS Suggested Flow Rate	200 –800 mL/minute (User uses FS-100 to set this parameter)
FR-300-PLUS Flow Interlock	Brush Motor Turns Off when in Auto Mode if Flow <50mL/min and On When >200mL/Min
FR-300-PLUS Rotational Speed	200 RPM – Motorized Brush
UC-80 Display	4.3-inch LCD Color 480 x 272 Pixel Resolution / Resistive Touch
UC-80 Input	RS-485 Modbus – RTU
UC-80 Output	3x 4-20 mA / RS-485 Modbus-RTU / Modbus-TCP
UC-80 Relay	2x Relays (Passive Output or Active Output – User Selected)
UC-80 Data Storage	Built-In 128MB of Ram for Storing up to 1-Million Data/Event Records
UC-80 USB	1 x USB host, for data downloading and screen upgrade
UC-80 Relative Humidity	20% - 90% (No Condensation)
UC-80 Altitude	<6,561 feet (<2,000 Meter)
Panel Power Supply	96-260VAC / 50-60 Hz; 60 W USA Type B Plug
Panel Storage Temperature	-4 – 158 °F (-20 – 70 °C)
Panel Dimension (H x W x D)	Panel 450H x 750W x 180D mm
Panel Approximate Weight	Panel ~ 10 kg
Panel Wet Material	Polycarbonate/304SS/316SS/Glass/Gold/Platinum/CPVC/PTFEPOM/ABS/PEEK/PET/NBR
Rating	IP-65 Panel-Display / IP-67 Sensors
Compliance	EPA 334.0 / ISO 7393
Regulation	CE Marked / RoHS / UKCA
Selectivity	Non-Selective, cross sensitive to other oxidizing species
Warranty	6 Months Electrode / 13 Months Sensor Body & Panel
Typical Electrode Service Life	2 years
Typical FR-300-PLUS Brush Life	12-18 months depending on application of use
Pyxis 4G CloudLink™	Included & Activated On Request with Enrollment – Contact Pyxis Lab for details

2. Product Description

The OxiPanel-PLUS IK-765SS-NCL-BP is a pre-mounted inline multi-parameter analyzers with integrated ultrasonic flow control specifically designed as a 'Turn-Key' monitoring solution for challenging water applications including cooling water, food and industrial process water, raw water and treated wastewater effluent applications. The OxiPanel-PLUS series offer highly accurate, repeatable, and real-time measurement of multiple oxidizer species as well as pH, ORP and temperature utilizing proprietary Pyxis Lab smart sensor technology, coupled with a Pyxis UC-80 color touch screen display/data logging terminal and the Pyxis FS-100 ultrasonic flowmeter with regulating valve. The OxiPanel-PLUS also incorporates the uniquely designed FR-300-PLUS automated mechanical brush flow assembly to maintain optimum sensor electrode cleanliness in the most challenging water where conventional membrane amperometric or wet chemistry analyzers would fail.

The panel design is equipped with the propriety Pyxis ST-765SS-NCL smart sensor. The ST-765SS-NCL sensor measures Monochloramine, pH, ORP and temperature of the sample water. This Pyxis sensor design is membrane-free and based on unique principles and incorporates Pyxis' advanced technology in the field of bare-gold electrochemical detection. The ST-765SS-NCL sensor measures the Monochloramine residual and pH simultaneously while performing temperature and pH compensation for the measurement of oxidant based on conditions present in the application of use. Each OxiPanel-PLUS panel is also equipped with the FR-300-PLUS mechanical brushing flow assembly to ensure constant electrode cleanliness and the UC-80 color touch screen display and data logging terminal.

The OxiPanel-PLUS series also offers the FS-100 ultrasonic flow sensor and motor valve control module providing precise measurement and control of the incoming water sample flow based on user defined setpoint without the challenges commonly associated with mechanical flow measurement in dirty water applications.

The OxiPanel-PLUS series requires a small installation footprint, is simple to install and startup allowing users the benefit of a 'Turn-Key' solution for their oxidizer monitoring needs in real-world challenged water applications.



OxiPanel-PLUS Series

3. Features

- Pyxis ST-765SS-NCL (Monochloramine + pH/Temperature/ORP) is a composite sensor used for the measurement Monochloramine, pH ,ORP and temperature in compliance with USEPA 334.0 and ISO-7393 guidelines. The sensors advanced PCB offers built-in temperature and pH parameter compensation (up to pH 9.0+) algorithms eliminating the need for a supplemental pH sensor and controller. Unique Bare-Gold electrode technology for Monochloramine measurement eliminates membranes and electrode solution replenishment commonly associated with conventional sensors. The ST-765SS-NCL has a uniquely designed flat bubble pH electrode design for reduced fouling potential. Reduce your maintenance and cost versus conventional electrochemical sensors by utilizing Pyxis replaceable Electrode Head (EH-765) for this sensor allowing for years of reliable service. The ST-765SS-NCL sensor may be calibrated in-situ after cleaning via Indophenol test measurement of the active flowing sample.
- The Pyxis FR-300-PLUS is a magnetic coupling motorized brush flow assembly that provides an inline mechanical cleaning of the ST-765SS Series bare gold electrode enabling sensor accuracy in challenging industrial cooling and process waters. This unique device enhances the convective mass transport of the oxidizer analyte to the sensor surface eliminating the need for precision flow control commonly required for other amperometric sensors on the market. The FR-300-PLUS also provides supplemental deactivation protection of the bare gold electrode for long life, stability and accuracy. The brushing operation of the FR-300-PLUS is activated by the pre-mounted FS-100 ultrasonic flow meter included on the OxiPanel-PLUS Series analyzers. The FR-300-PLUS also contains a ‘chemical detergent injection port’ in the assembly housing allowing for the optional injection of cleaning agents at the brush head for extremely challenged industrial waters containing oils and grease. The FR-300-PLUS may be operated at a broad range of sample flow from 200 and 800mL per minute with an inlet pressure of 7.5 - 60 psi. The FR-300-PLUS outlet flow line may be diverted to atmospheric tank/sump within the process itself for reuse or to a lower pressure zone of the recirculating water network.
- The Pyxis FS-100 is a state-of-the-art ultrasonic flowmeter that operates on the principle of transit time difference with a measurement range of 0 – 3,000 mL/min and resolution of 1mL. The sensors advanced PCB design offers built-in temperature compensation to eliminate the effect of temperature with instantaneous, accumulated, and controlled water flow based on user setpoint within the sensor itself. The sample flow rate is controlled via PID logic from the flow sensor to the pre-mounted motor valve on the OxiPanel-PLUS analyzer.
- Each OxiPanel-PLUS is provided with one UC-80 display that powers the ST-765SS Series sensor, FR-300-PLUS, FS-100 and valve based on the user programmed flow setpoint and system operation. UC-80 touch screen display/data logger provides sensor calibration & diagnostic interface with 3x 4-20mA, RS-485 and TCP output with relay.
- The OxiPanel-PLUS contains the Pyxis 4G CloudLink™ and global SIM card as a comprehensive data gateway to cloud device for live mobile APP trend view, data download and reporting. Contact Pyxis for details.

4. Part Numbers & Ordering Details

Please find a table below outlining ordering details and part numbers for the OxiPanel PLUS Series of analyzers and replacement-spert parts.

Order Information	P/N
OxiPanel-PLUS IK-765SS-NCL-BP <i>(Auto Brushing Monochloramine + pH Analyzer w/Flow Control)</i>	49348
Optional / Replacement Accessories Information	
ST-765SS-NCL <i>(Monochloramine + pH + Temperature Sensor w/Internal Compensation-Sensor Only)</i>	53623
EH-765 <i>(Replacement Electrode Head for ST-765SS-Series Sensors)</i>	53061
FR-300-PLUS <i>(Replacement FR-300-PLUS Auto-Brushing Flow Assembly Replacement)</i>	50700-A44
FRP-300-01 <i>(Replacement Brush Assembly Kit for FR-300-PLUS)</i>	50700-A49
FS-100 <i>(Replacement Ultrasonic Flowmeter with Display 0-3000mL/Minute)</i>	54200
Flow Regulating Motorized Valve w/4-20mA Control <i>(Replacement)</i>	21972
UC-80 Display + Data Logging Terminal <i>(Replacement)</i>	14003
Pyxis pH Combo Calibration Pack <i>(pH 4-7-10 Calibration Solution 3-Pack - 500mL ea.)</i>	57007
Pyxis ORP Calibration Standard <i>(200mV ORP Calibration Solution – 500mL)</i>	57020
Pyxis Zero Oxidizer Calibration Standard <i>(0ppm Oxidizer Solution – 500mL)</i>	21022
Pyxis Probe Cleaning Kit <i>(Probe Cleaning Solution, Brush, Qtips & Jar – 500mL)</i>	SER-01
SP-200 OxiPocket™ <i>(Pocket All-Oxidizing Disinfectants Colorimeter & Fluorometer)</i>	50802

5. Analyzer Dimension and Mounting

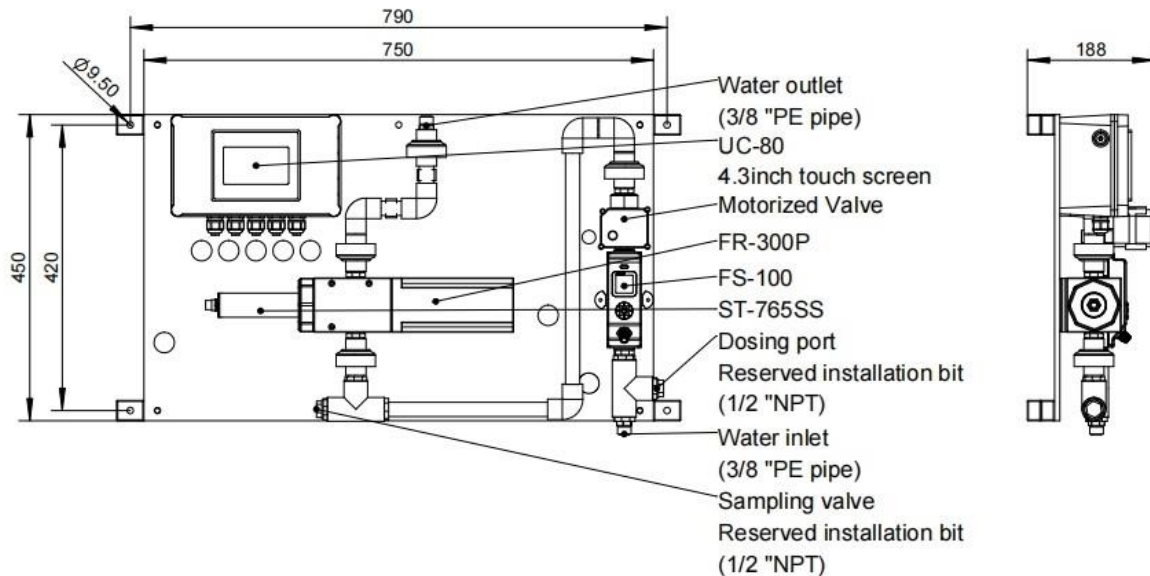

Figure. 1 - OxiPanel-PLUS IK-765SS-BP Series

6. Analyzer Installation

6.1. Installation Requirements

Power Supply: 96-260VAC / 50-60 Hz; 60 W

Inlet Water Supply: The inlet water pressure should be from 7.25 – 60 psi (0.05-0.413MPa) with an inlet feedwater line diameter of 3/8-inch OD tubing adapter threaded into 1/2-inch FNPT socket. ***NOTE*:** Users can program the desired inlet sample water flow on FS-100 screen interface as outlined in Section 6.4 of this manual. The recommended inlet sample water flow should be between 200-800ml/min.

Outlet Water Line: The sample water outlet diameter is 3/8-inch OD tubing adapter threaded into 1/2-inch FNPT socket. This line should be returned to atmospheric sump or lower pressure recirculation line of the analyzed system water network.

Wall Mount Space: The OxiPanel-PLUS analyzer panel size is roughly 450H x 750W x 180D (mm) in dimension. Please leave at least 0.5m of installation space around the equipment for later maintenance.

Wall Mount Weight: Approximately 10kg. Please use appropriate mounting hardware.

6.2. Sample Water Connection

1. **Sample Water Inlet:** Connect the inlet water $\frac{3}{8}$ -inch OD tubing to the quick adapter provided.
2. **Sample Water Outlet:** Connect the outlet water $\frac{3}{8}$ -inch OD tubing to the quick adapter provided.

NOTE OD Tubing adapters are provided as a convenience. If desired, users may remove the $\frac{3}{8}$ -inch OD tubing adapter and directly plump the sample water inlet/outlet via $\frac{1}{2}$ -inch NPT piping to the OxiPanel-PLUS analyzer.

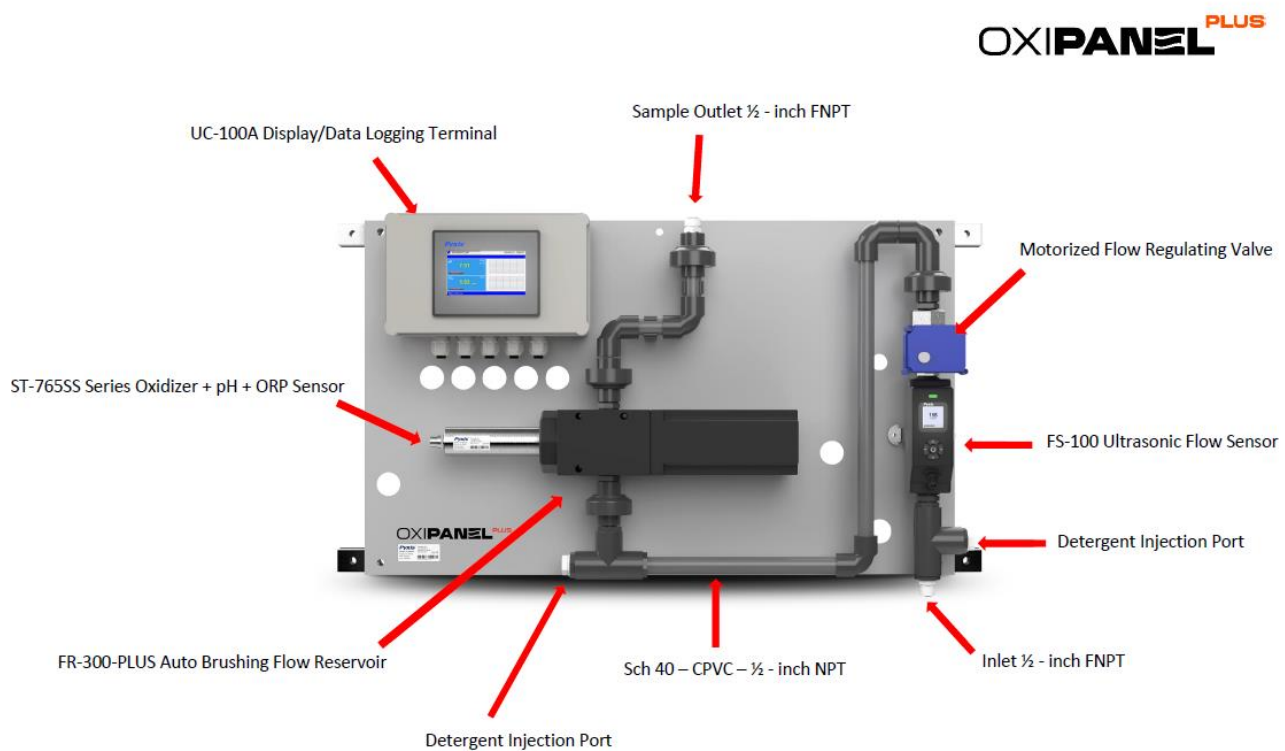

Figure. 2 OxiPanel PLUS Diagram Overview

6.3. Terminal Board Wiring

6.3.1. UC-80 Display Wiring Diagram

The OxiPanel-PLUS IK-765SS-NCL-BP series has universal AC power supply equipment allowing users simply to plug the power supply into a 100~240V AC 50/60Hz power outlet for normal operation.

The two relay outputs are defaulted to "Active Output", which can be switched to "Passive Output" by toggling the button on the board, as shown below in the orange box. When in ACTIVE mode, the relay is 24VDC powered. When in PASSIVE mode, the relay is a dry contact.

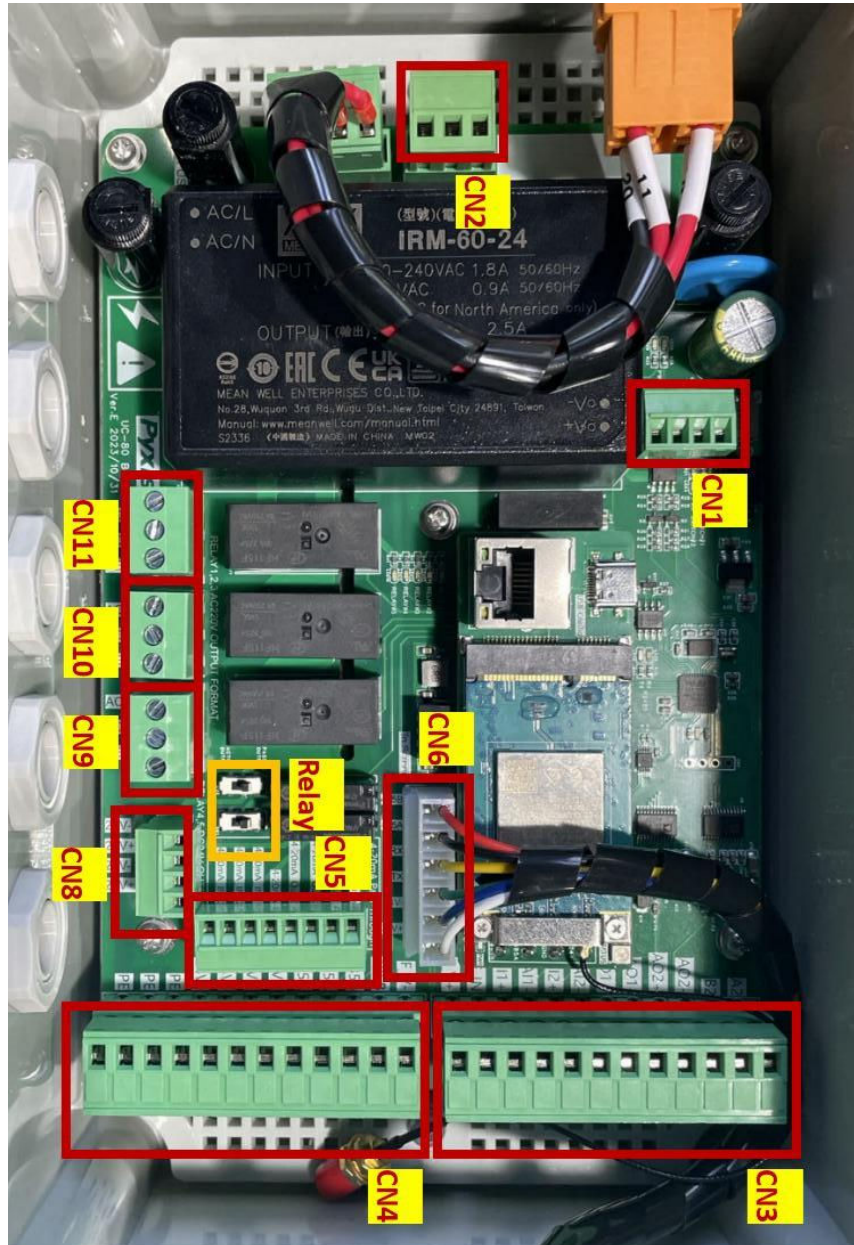

Figure. 3 – Terminal board of the UC-80 Display

The Pyxis Factory connect all pigtail output cables to the controller internally except for relay #1. The pigtail connection allows for rapid wiring and ease of installation. Please refer to the following diagram for the definition of each terminal. Relay #1 is available for customer use when wired internally to terminal block.

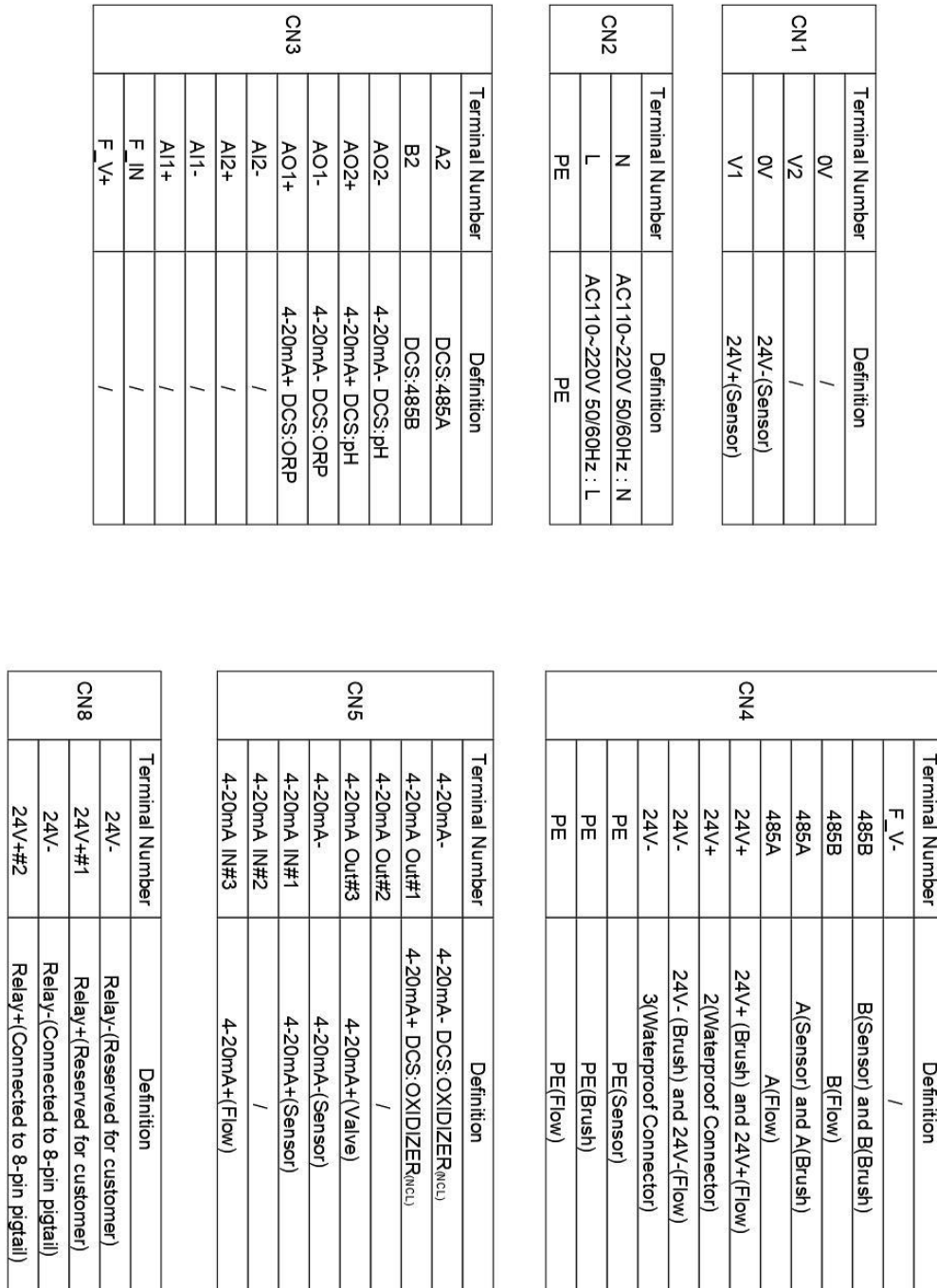

Figure. 4 - Terminal Wiring Diagram

WARNING - The process of electrical connection to contact the 96-260VAC single-phase power supply, should be operated by personnel with an electrician's license. Failure to operate according to the electrical code of practice may result in electric shock injury or even death.

6.3.2. UC-80 Display Pre-Wired Output Cable

The UC-80 display and data logging terminal of the OxiPanel-PLUS IK-765SS-NCL-BP series comes equipped with two prewired 8-pin pigtail cable with adapters. The input cable offers a male adapter for direct connection to the ST-765SS Series sensor input. This cable is to be terminated to the sensor only.

The output pigtail offers a female adapter. This pigtail cable is designed to be connected to the loose flying lead cable with male adapter and open wires that is provided with the panel. This 8-pin output enables 3x 4-20mA signal passthrough, 1x RS-485 and 1x Relay (Default is Active Output 24Watt, can be changed to Passive Output) output to pass onto another device. The loose flying lead cable can be rapidly connected directly to the equipment in the field. Wire labeling and color code can be found in the table in the lower left corner of Figure 5 seen below, or rewired to the equipment according to the wiring diagram shown in Figure 4.

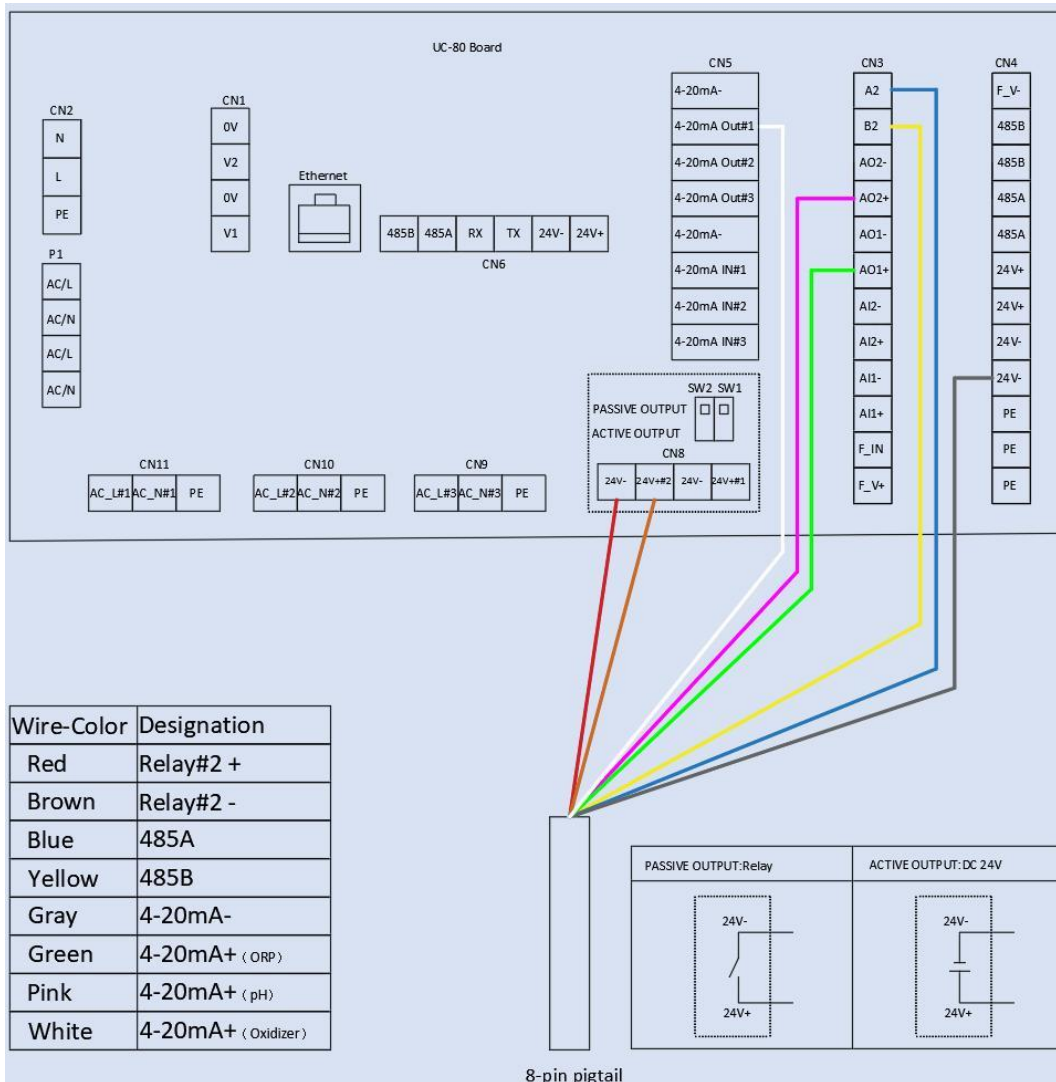
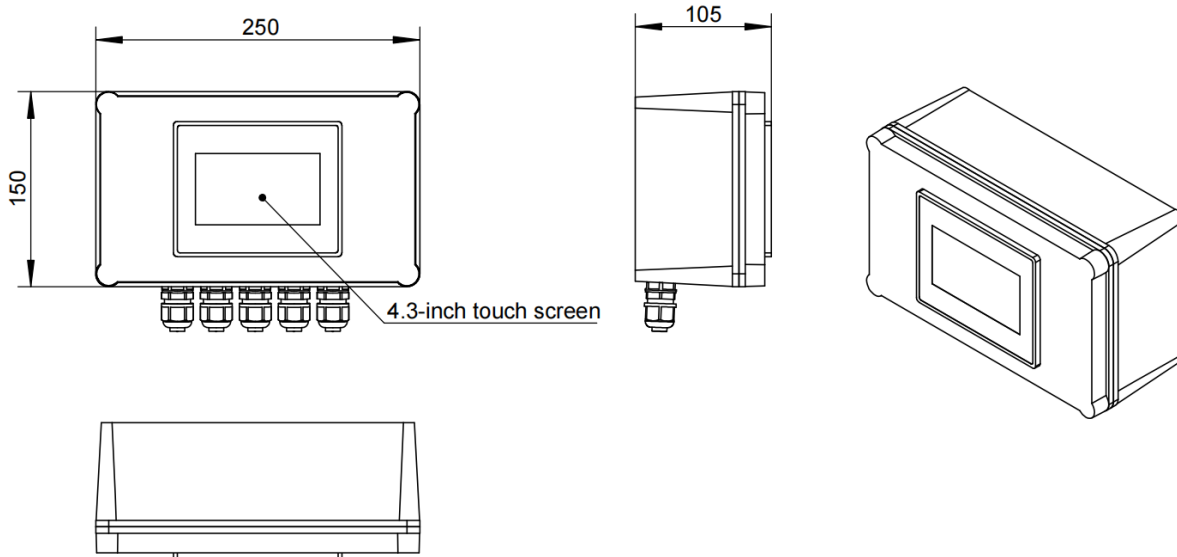

Figure. 5 - Pre-Landed Output Flying Lead Cable Wiring Diagram

7. Analyzer Components & Dimensions

7.1. UC-80 Display & Data Logging Terminal (mm)



7.2. FS-100 Ultrasonic Flow Meter (mm)

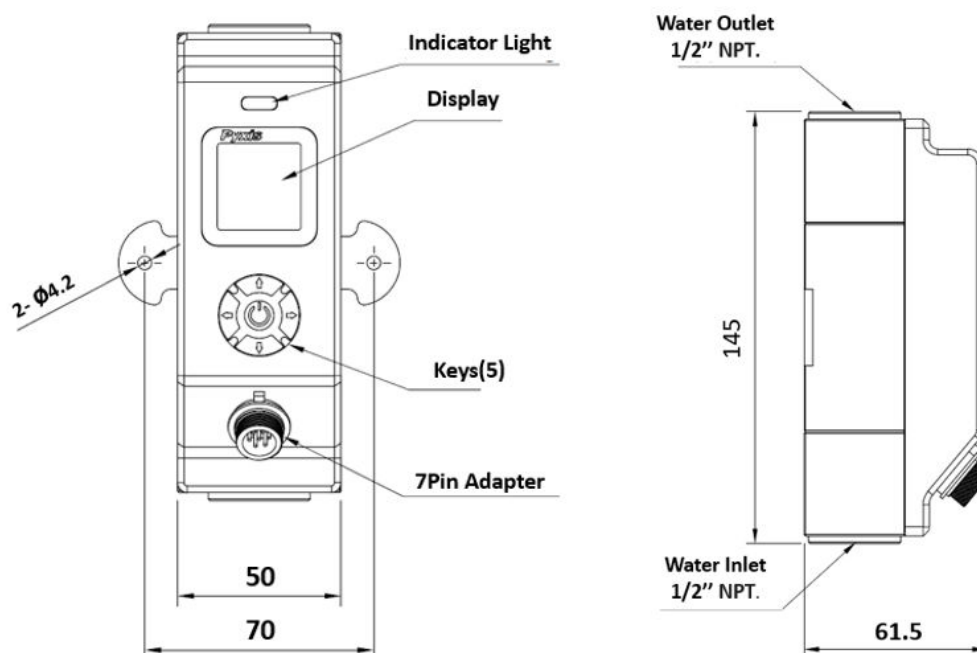

7.3. FR-300-PLUS Automatic Brushing Flow Assembly (mm)

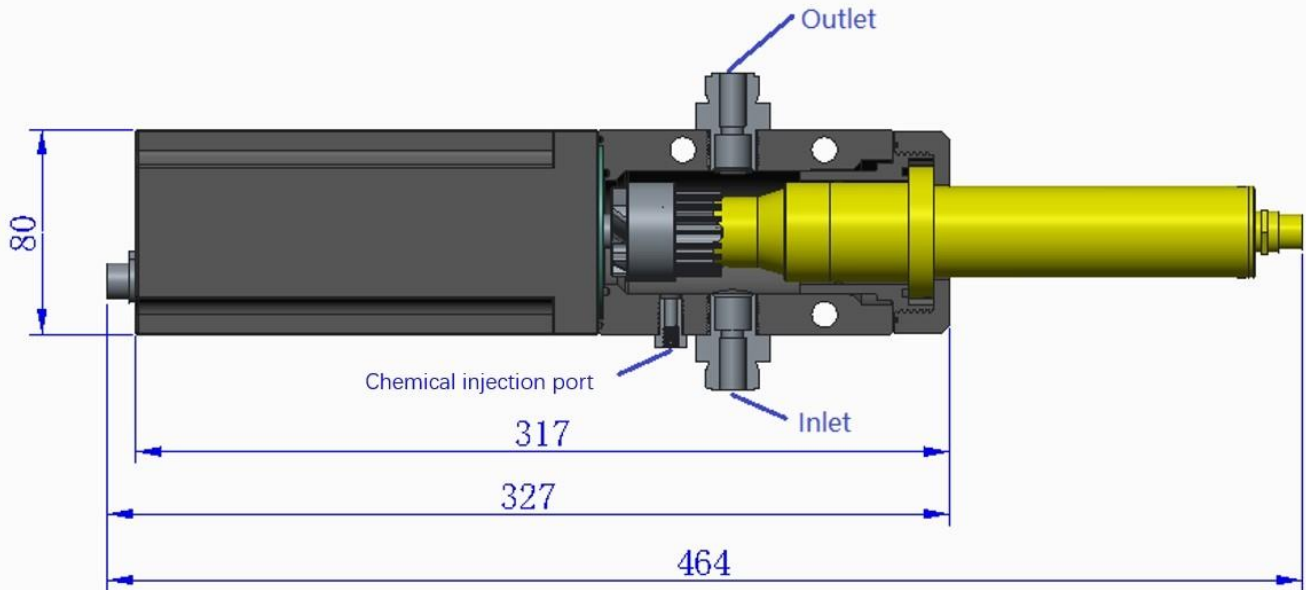

7.4. ST-765SS Series Sensor (mm)

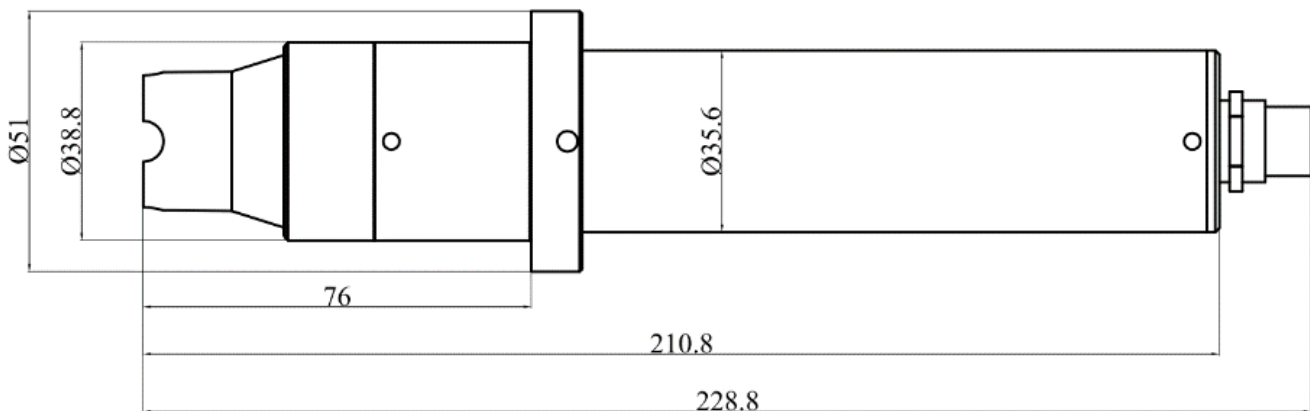

8. FS-100 Flow Control Module Overview & Use

The Flow Control Module is a stand-alone water flow measurement and control solution, a unique platform that provides accurate flow measurement and regulation. The Flow Control Module is equipped with the Pyxis FS-100 ultrasonic flow meter with display, which allows direct control of pre-installed regulating valves through a simple user programmable interface and a measurement range of 0 – 3,000mL/min.

8.1. FS-100 Key Function

Enter Key

- Main screen → Setting Menu.
- Confirms and saves the input values.

Left / Right Key

- Main screen → Trend Chart.
- Move the cursor to the left or right.
- Turn pages on the screen.

Up / Down Key

- To increase or decrease a displayed number value.
- Jump up and down in the operating menu.

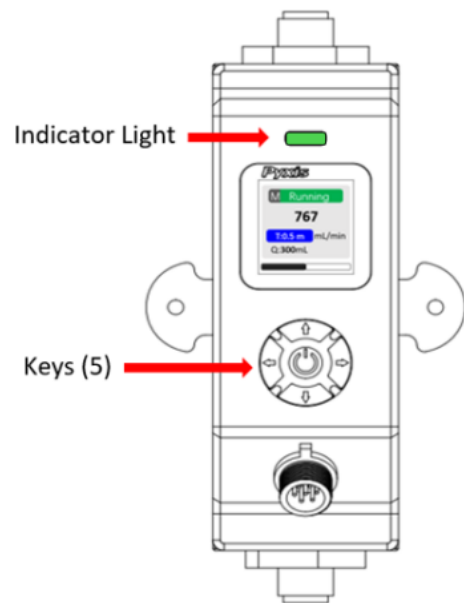

LED Status Indicator

The status LED is used for a quick visualization of the flowmeter status.

LED Behavior	Status
Green	Normal Running
Red	Alarm Information

8.2. FS-100 Main Screen

Main Screen Description

NO.	Description
1	Flow Detection Mode ⁽¹⁾
2	Working Status (same color as LED status indicator)
3	Flow Rate Value
4	Timer ⁽²⁾ (unit: auto range)
5	Unit of measured flow value
6	Accumulated Flow Value (unit: auto range)



(1) R = Average Flow Rate Mode

M = Instantaneous Flow Rate Mode

C = Flow Rate Control Mode ***NOTE*** For C-Mode refer to Section 7.4 for programming details.

(2) The **Timer** feature is enabled when the FS-100 is powered on and can be set by pressing the ▼ key.

- **Pause or Restart the Timer:** Press ▼ key momentarily and release.
- **Reset the Timer:** Press and hold ▼ key for about two seconds

8.3. FS-100 Flow Trend Chart

From the main screen, Press ◀ or ▶ to the trend chart display. Flow values will be displayed as a line graph to show the real-time trend. Press ◀ or ▶ to return to the main screen.

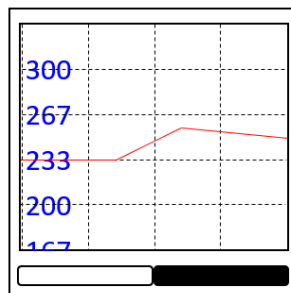

Figure. 6 - FS-100 Flow Trend Chart

8.4. FS-100 - Setting the C-Mode for the Sample Flow Control

The Oxipanel PLUS series are programmed to use the Flow Rate Control (C) mode by default, which does not need to be changed by the customer. If a change to measure only is desired (with no control) users may follow the steps below to adjust the FS-100 functional settings.

Press ◀ or ▶ in the setting menu and select **[Pattern]**. The following operating modes are available:

- **Flow Rate (R)** = Display the average flow rate
- **Flow Meter (M)** = Display the instantaneous flow rate
- **Flow Control (C)** = Set a desired constant flow rate

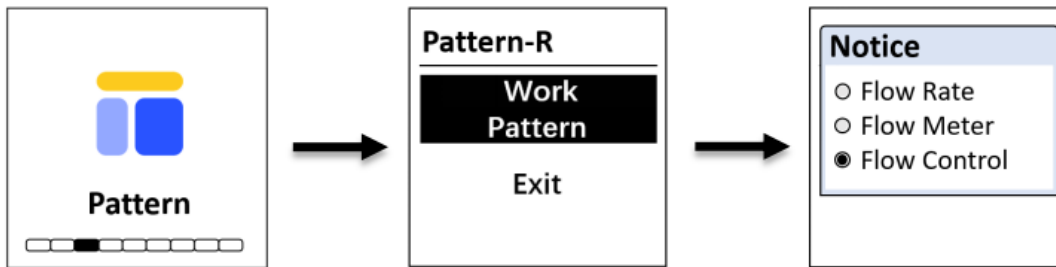

Figure. 7 - Operating Mode

When Flow Control Mode (C) is selected, a user defined flow rate setpoint must be entered (Figures 6 & 7). The FS-100 will automatically control the regulating valve according to the preset flow rate with an internally calculated PID algorithm.

NOTE The Oxipanel PLUS Series should be operated within the recommended flow rates of 200-800 mL/min. See Specifications Section 1.0

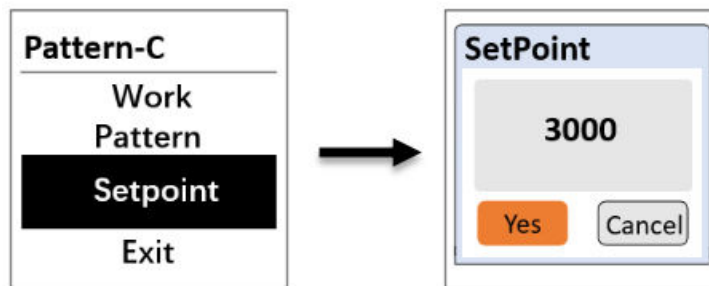

Figure. 8 - Flow Control (C) Operating Mode with User Defined Setpoint

NOTE If the actual flow rate does not reach the preset flow rate for a duration time of longer than two minutes, the main screen and LED indicator will display **RED** alarm status .

8.5. FS-100 Modbus Communication Settings

Press ◀ or ▶ in the setting menu and select **[Com]** to modify communication parameters (Figure 7).

The following communication settings are pre-programmed into the FS-100 for direct communication with the OxiPanel PLUS display interface. ***IMPORTANT NOTE*** These values should NOT BE ALTERED, otherwise flow control failure will occur.

- **Modbus Address = 95**
- **Baud Rate = 9600**
- **Parity = Even**

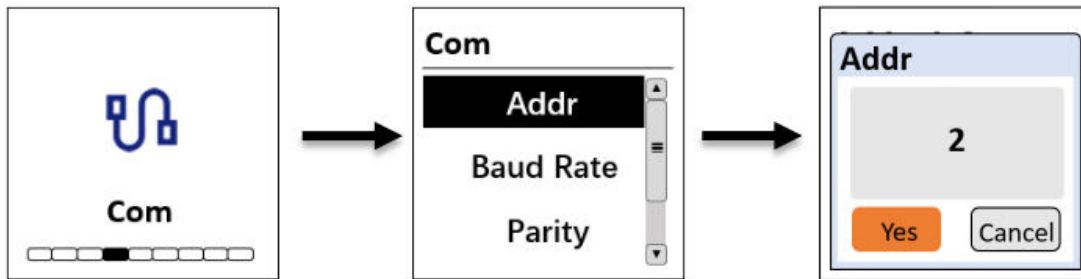

Figure. 9 - Communication Settings

8.6. FS-100 Factory Reset

If the user wants to restore all device settings to factory default parameters, Navigate to **[Info]** screen (Figure 10), press and hold ⏻ key for about two seconds, the FS-100 will reboot itself (Figure 9).

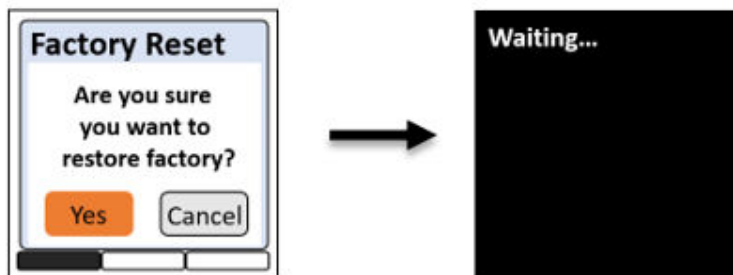

Figure. 10 - Factory Reset

8.7. FS-100 Device Information & Diagnosis

Press ◀ or ▶ in the setting menu and select **[Info]**. This screen contains the device name, serial number, software version, and hardware version. Provide an image of both the **DEVICE INFORMATION** screen and the **DIAGNOSIS** screen when you contact Pyxis (service@pyxis-lab.com) for troubleshooting your device or call +1 (866) 203-8397 ext 2.

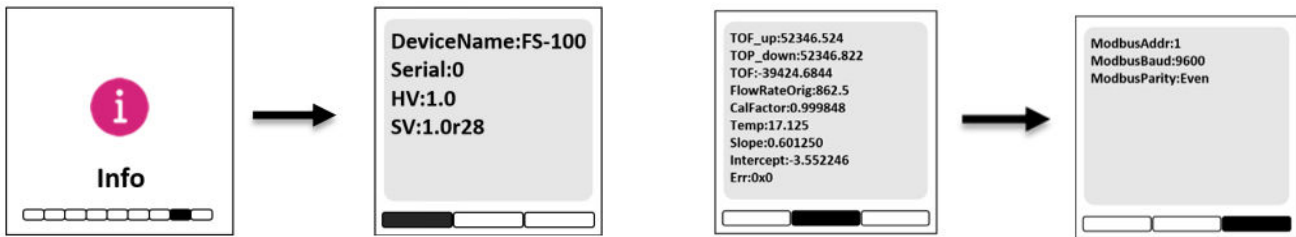

Figure. 11 - Device Information

Figure. 11A - Diagnosis

Press ◀ or ▶ to turn the page. This screen information has no use for normal operation, but instead is used for device troubleshooting. Provide an image of both the **DEVICE INFORMATION** screen and the **DIAGNOSIS** screen when you contact Pyxis (service@pyxis-lab.com) for troubleshooting your device or call +1 (866) 203-8397 ext 2.

9. UC-80 Display Touch Screen Operation

9.1. Main Screen

After the system is powered on an initial screen allows the user to log into the system.

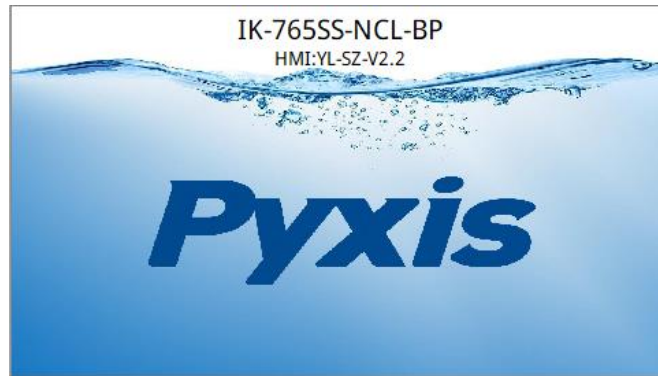

Figure. 12 - Main Screen

9.2. User Login & Password

After powering on the system, log in with the user name and password to be able to change system settings. Click the "User Login" button, select the user "pyxis", enter the password: "888888" in the user password field. A new user can be added via "User Management" in interface of the menu.

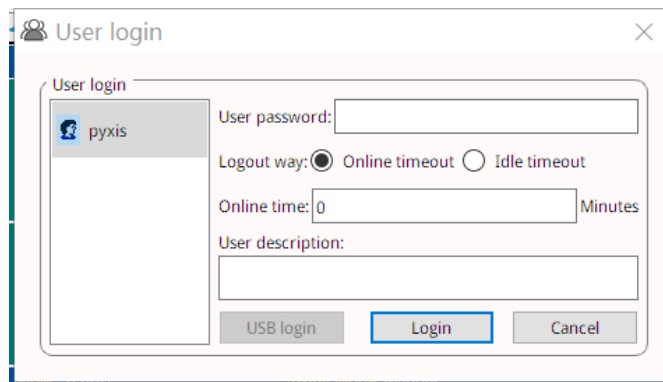

Figure. 13 - User Login Screen

If you do not need a password, or want to change the user, you can enter the system and manage in the "User Management" screen of the menu (See Section 9.11 of this manual)

9.3. Real-Time Monitoring

Click the "Enter System" button on the main interface to enter the real-time monitoring screen of the system. The data detected by the Pyxis sensors will be displayed in real-time. See a functional overview of each section of this screen highlighted below.

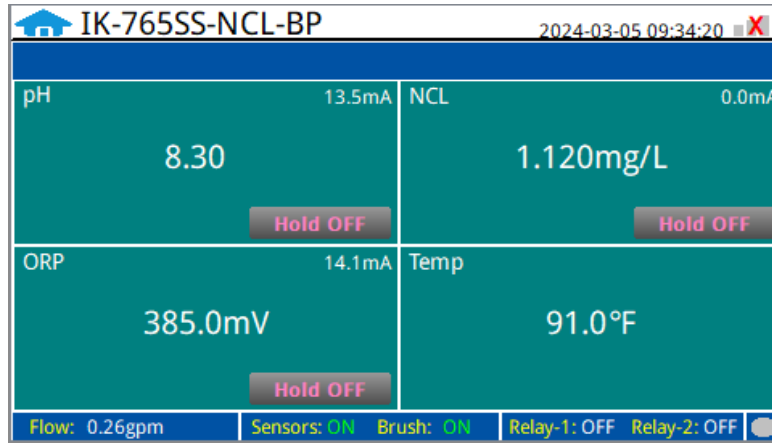

Figure. 14 - Real-time monitoring screen

9.4. Activating the 4G DTU Gateway/Module

Each OxiPanel Plus comes with a 4G DTU module with global SIM card to push sensor data to the Pyxis Cloud server. By default, the 4G DTU module is disabled. Please contact Pyxis Lab for pricing details and to activate the 4G DTU by emailing service@pyxis-lab.com. When the 4G DTU module is enabled, real-time sensor readings and historical data trends are available in the uPyxisPlus mobile app and the Pyxis Cloud web application. The 4G signal strength is displayed in the upper-right corner of the UC-80 display screen.

When contacting Pyxis Lab, please provide the PN and SN of the Pyxis device, which can be viewed in the label on the bottom left of the device, for example, "PN-49348 and SN-240001" in the image below. A sequential combination of these numbers will also serve as the 4G number of the device. (ie. 49348240001) After activation Pyxis Lab will provide user ID and Password details to allow for immediate cloud data access sufficient for 1-year.



Figure. 15 - Device Label

9.5. Explanation and use of the Output Signal HOLD Feature

The OxiPanel PLUS has an integrated HOLD feature for all output parameters from the sensor that would be connected to an onsite DCS network. The purpose for this feature is to allow the user to enter a signal value HOLD on the designated parameter during periods of sensor maintenance or removal. This feature prevents network system alarms from operational shutdown during sensor maintenance or replacement.

Click the "Hold OFF" button on the main interface to enter the HOLD setting interface.

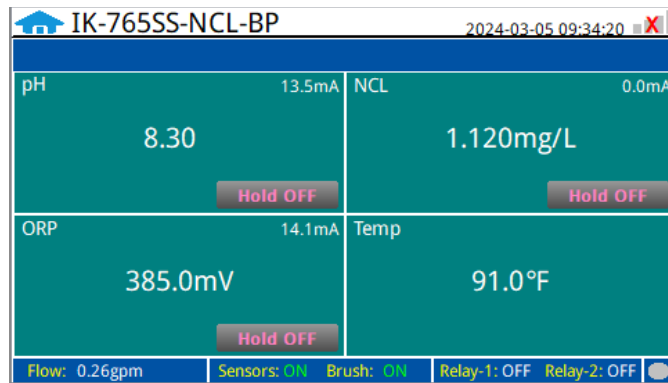

Figure. 16 - Main Interface

In "Set Value" users can enter the parameter value to be held, clicking on "Confirm" will turn the "Hold ON" function on, at this point the unit's 4-20mA, RS-485 Modbus-RTU and Modbus-TCP will continue to hold the value entered by the user, ensuring that network alarms and processes are not interrupted by the sudden change of the "actual" value. During this time, the main screen will display the sensor's "actual" real-time measured value, and the user-entered hold value reading will be displayed in the lower left corner of that measured value box.

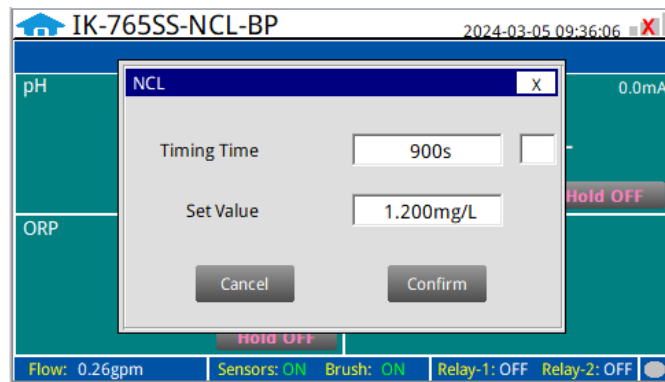

Figure. 17 - Hold Feature

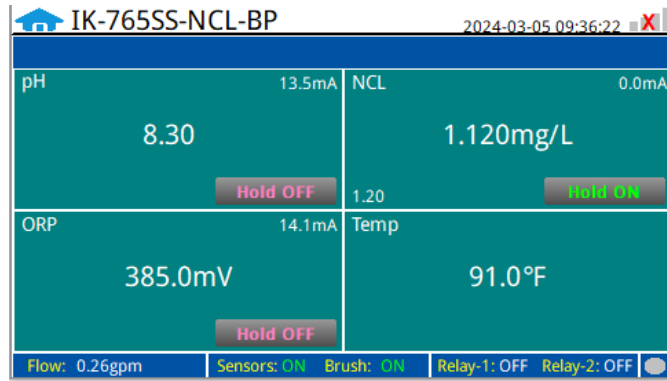

Figure. 18 - Hold ON Interface

If the "Hold ON" function needs to be turned off, click on the "Hold ON" button to return to the setup screen, and click on "Cancel" and the main screen will immediately display the real-time value read by the sensor, and the main screen button will be displayed as "Hold OFF".

In the setting interface, you can select "Timing Time" to enable the auto time out function and set the required duration. When the Hold value is set, a countdown will be performed. When the countdown ends, the "Hold ON" will be automatically changed back to "Hold OFF". The countdown timer is also displayed in the lower left corner of the measured value box

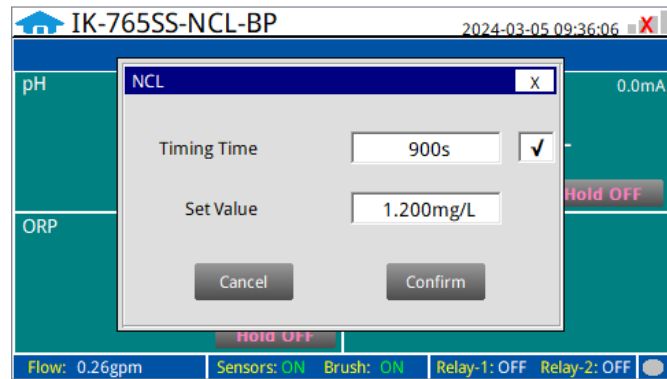

Figure. 19 Hold Function Timing Time

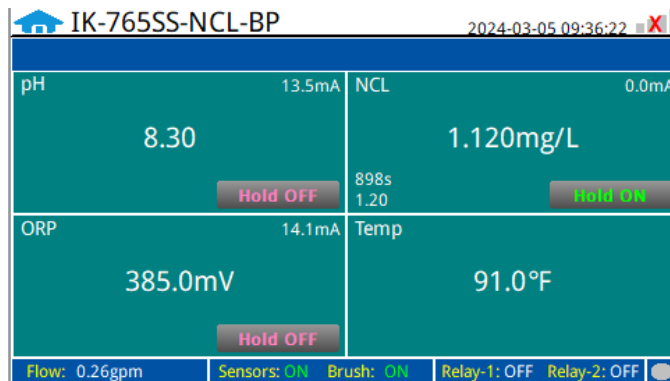

Figure. 20 Main Interface

9.6. Menu Bar

Click the button in the upper left corner of the screen to enter the system's menu interface, where the user can select to enter the desired operation interface.

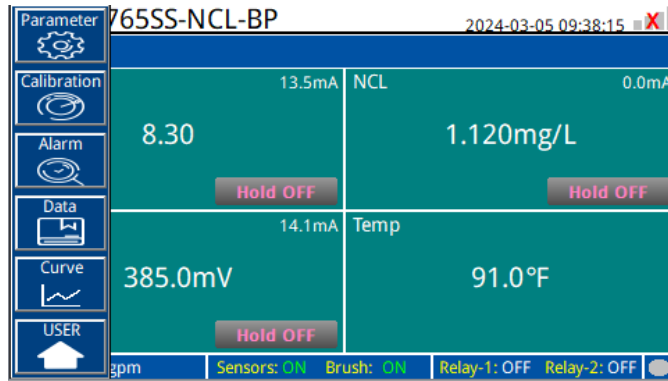

Figure. 21 - Menu Bar

9.7. Configurable Parameters

Click the "Parameter" button in the menu bar. Here you can select a list of options to include enter **Control Interface / Settings Interface / User Defined Settings / Diagnostic Data / 4-20mA Output Setup** and **Comm Setup**.

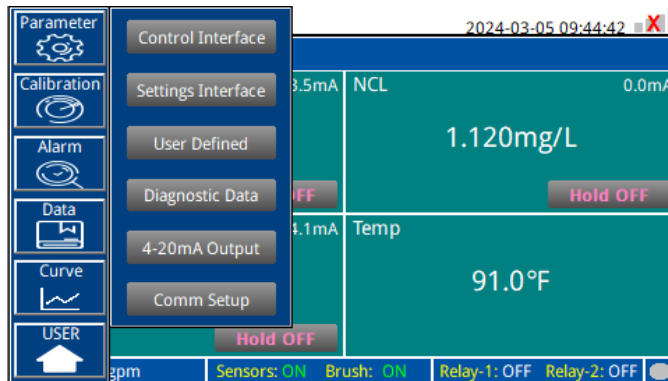

Figure. 22 - Parameter Settings Menu

9.7.1. Control Interface

Clicking on "Control Interface" opens a sub-menu for Flow Interlock Control and Relay Output Control.

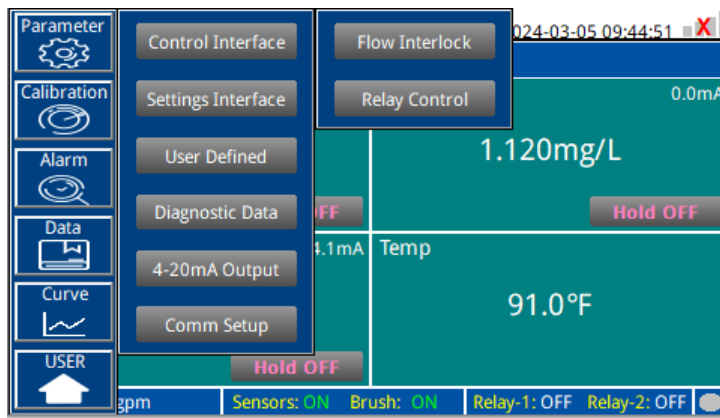

Figure. 23 - Control Interface

Flow Interlock Control

In the "Flow Interlock" users can select the flow interlocked control mode for the FR-300-PLUS brushing reservoir as well as the ST-765SS Series sensor of the OxiPanel PLUS system being used.

When placed in **Manual Mode**, users can independently power ON and OFF both the FR-300-PLUS and ST-765SS Series sensor as desired.

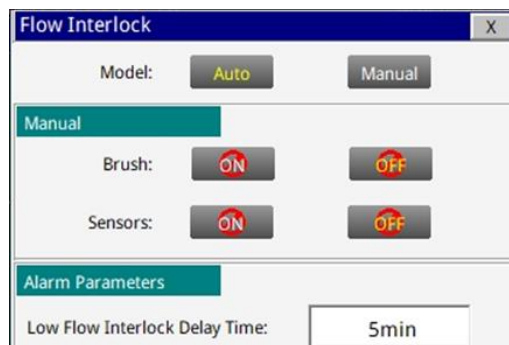

Figure. 24 - Flow Interlock Control – Auto & Manual Mode

When in **Automatic Mode** both the FR-300-PLUS brush motor and ST-765SS Series sensor will be interlocked with the FS-100 inline ultrasonic flow meter and will only remain powered ON simultaneously if the sample water flow rate is greater than 200ml/min.

When the sample water flow is less than 50ml/min, the FR-300-PLUS brush motor and ST-765SS Series sensor will be powered OFF and the main interface will display "----"; until the sample water flow returns to >200ml/min at which time the brush will start immediately, and the sensor will display a live reading after a 5min electrode initialization period. The flow interlock delay (judgement time) default is 5-minutes, however this may be user adjusted.

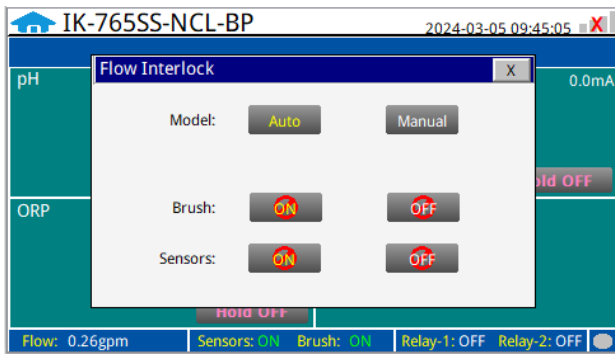

Figure. 25A - Flow Interlock Control - Automatic Mode

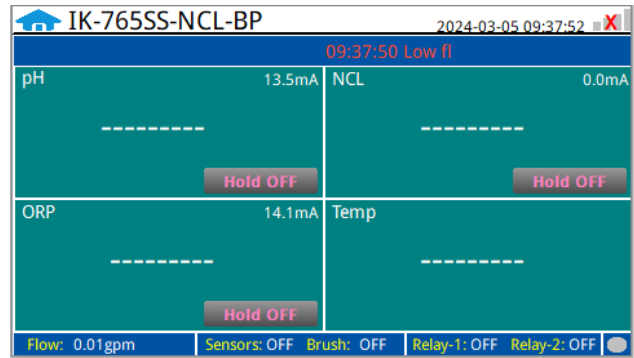

Figure. 25B - Numeric Display "---" with Flow <50mL/min

NOTE In the event of a sudden power loss, the Flow Interlock Control mode will return to the same settings that were programmed before the power failure.

Relay Output Control

The OxiPanel PLUS has two (2) 24VDC relay outputs. Relay #2 is pre-wired to the 8-pin pigtail cable output for rapid connection while Relay #1 remains unwired available for connection internally as needed.

The two relay outputs are defaulted to "Active Output", which can be switched to "Passive Output" by toggling the button on the board, as shown below in the orange box. When in ACTIVE mode, the relay is 24VDC powered. When in PASSIVE mode, the relay is a dry contact.

NOTE Relay #1 is available for use by wiring directly to the terminal block within the UC-80. Relay #2 is pre-landed to the output flying lead cable for easy for integration by the user. This may be removed if desired. (See Section 6.3.2 for details)

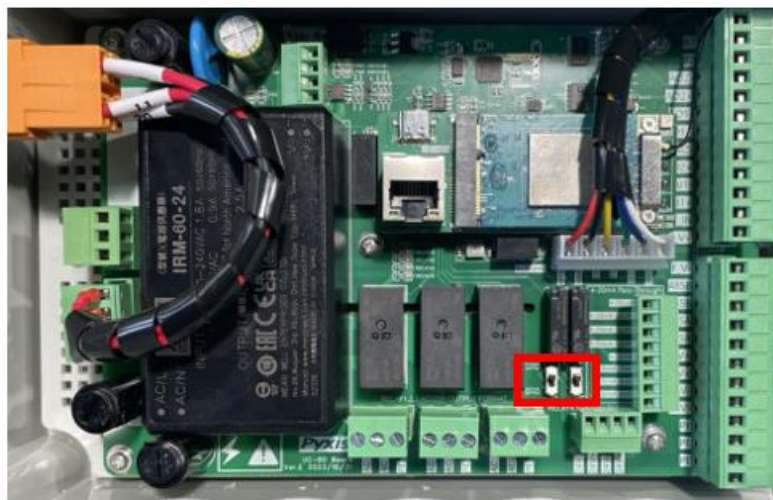

Figure. 26 – Relay Active/Passive Toggle Switch on UC-80 Terminal Board

Both Relay outputs have 4 modes of operation including **Disable / Manual / Periodicity** and **Sensor Value**

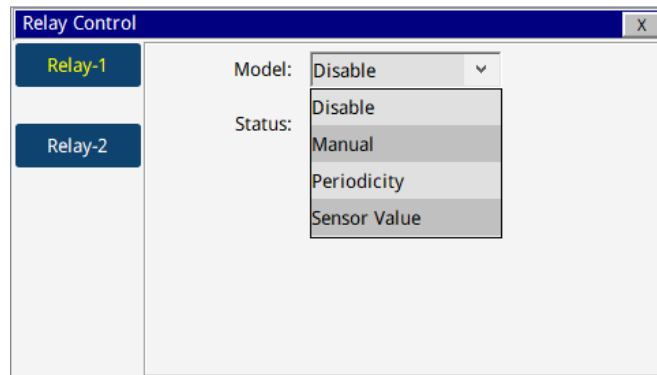

Figure. 27 – Relay Output Control

When the mode selection is set to **Disable**, there will be no relay output available.

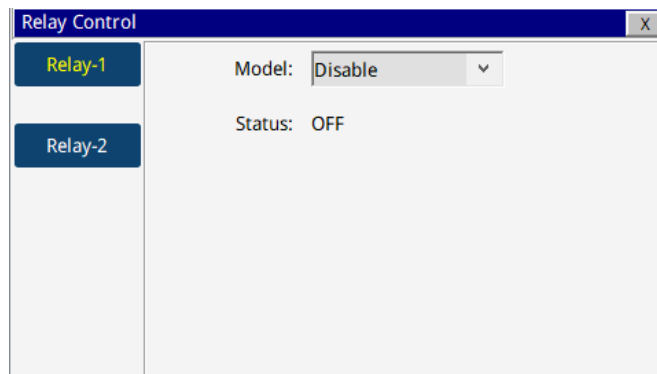

Figure. 28 – Disable

When the mode is selected as **Manual**, users can manually turn on the Output by clicking the "Turn On" button in the lower right corner and turn it off by clicking the "Turn On" button again.

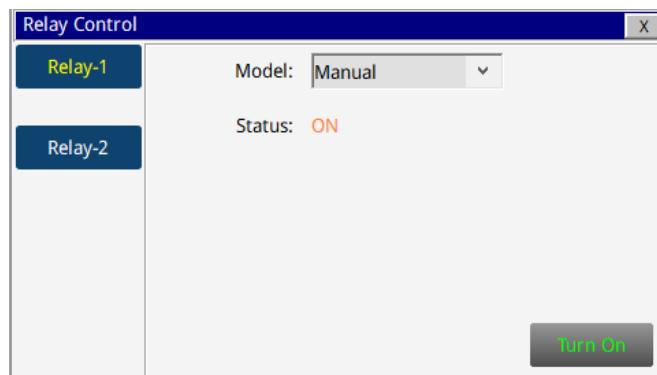

Figure. 29 – Manual

When the mode selection is **Periodicity**, it will periodically output according to the user programmed Interval Time and Running Time

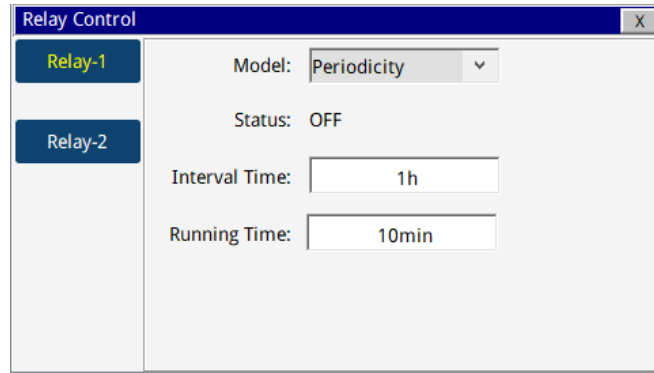

Figure. 30 – Periodicity

When the mode selection is **Sensor Value**, users can select which parameters they desire to control. See examples below.

Example 1: Open (ON) Value = 0.2
 Close (OFF) Value = 0.5
 Measured Value \leq 0.2 will Open the Relay
 Measured Value \geq 0.5 will Close the Relay

Example 2: Open (ON) Value = 0.5
 Close (OFF) Value = 0.2
 Measured Value \leq 0.2 will Close the Relay
 Measured Value \geq 0.5 will Open the Relay

Users can utilize the **Protection Time** to prevent over activation of the relay if the responding parameter does not come within desired range within a specified time. After relay opening, when the measured value continues to exceed the set shutdown value beyond the protection time, the relay will automatically shut down the output. This feature allows for overfeed prevention.

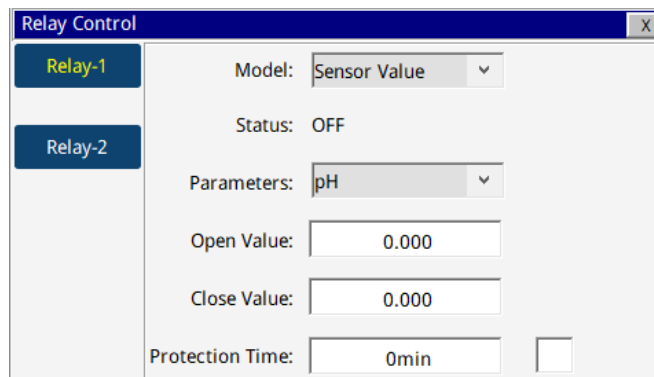

Figure. 31 –Sensor Value

9.7.2. Settings Interface

Clicking on "Settings Interface" tab opens a sub-menu for Alarm Parameters and Sensor Papermeters.

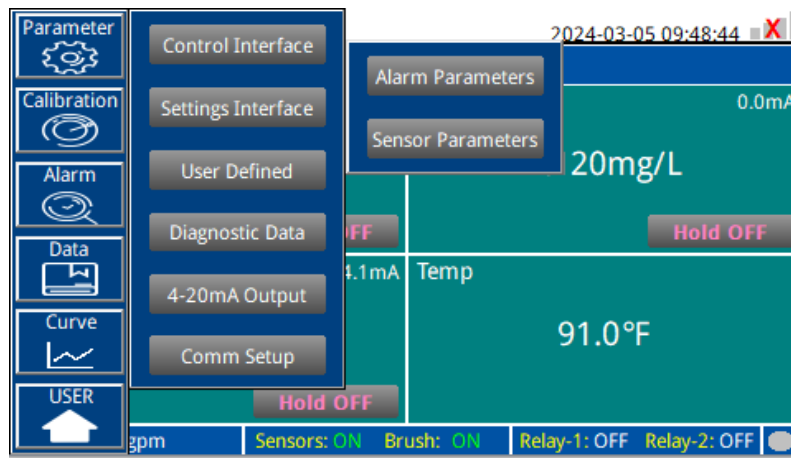

Figure. 32 –Setting Interface

Alarm Parameters Setting

Users can set the upper and lower alarm limits. Click "Alarm Parameters" to enter the alarm parameter settings. When the measured sensor value is lower than the set lower limit (the XX lower limit alarm) or when the measured value is higher than the set upper limit (the XX upper limit alarm), the corresponding sensor alarm will be displayed on the real-time monitoring screen. The user can also choose to turn the alarm display on or off at the top right of the corresponding parameter list.

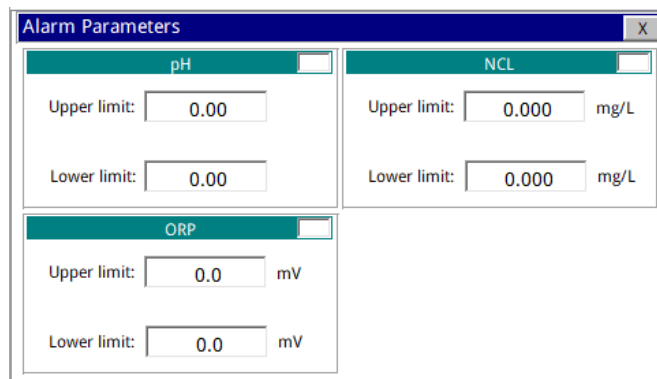

Figure. 33 - Alarm Parameter Setting

Sensor Parameters - Smoothing Factor Description & Adjustment

In "Sensor Parameters" within the "Settings Interface" field of the "Parameter" menu, users can set the smoothing coefficient for the sensor. Usually the oxidant concentration is a very small signal, which is easily subject to external interference. The ST-765SS Series sensors adopt a continuous smoothing and averaging algorithm to filter out these minor interferences. A suitable smoothing factor setting can allows users to obtain a high-quality measurement and suitable dynamic response based on the application needs. The smoothing factor setting regulates the speed of sensors response.

The higher the smoothing factor value, the faster the sensor response and the lower the interference and noise suppression enabling a more rapid response to any changes of the real value. The lower the smoothing factor value, the slower the sensor response and the better the interference and noise suppression, but the slower the response to the real value change.

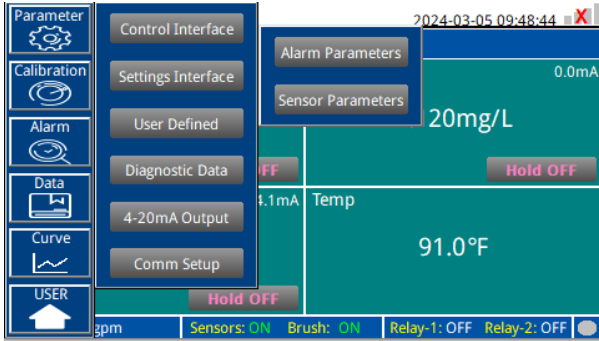

Figure. 34 - Settings & Sensor Parameters Interface

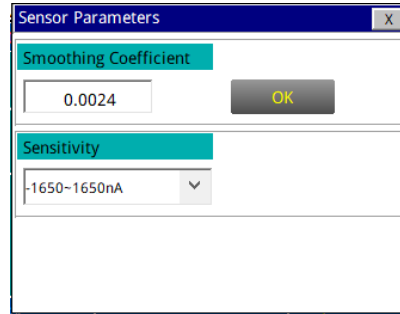

Figure. 35 - Smoothing Coefficient

Pyxis Lab uses the term “T90” when the measured value of the sensor reaches 90% of the true value to describe the speed of the sensor response in seconds. The default smoothing factor of ST-765SS Series sensor is **0.0024 (T90≈4 minutes)**. The available setting range of the smoothing factor is 0.001 to 0.9. The following table outlines the comparison between the smoothing factor and T90 for the ST-765SS Series sensor and should be used if considering an adjustment to the smoothing factor settings.

Smoothing Factor	T90 (Seconds)
0.1	5.5
0.09	6
0.08	7
0.07	8
0.06	9.25
0.05	11.25
0.04	14
0.03	19
0.02	28.5
0.01	57.25
0.009	63.75
0.008	71.75
0.007	82
0.006	97.5
0.005	114.75
0.004	143.5
0.003	191.5
0.002	287.5

$$T_{90} \approx 0.538 * Smooth_factor^{-1.013}$$

NOTE The smoothing coefficient is not available when the sensor is in calibration mode.

9.7.3. User Defined Settings

The “User Defined” setting function allows users to assign a customized name, unit of measure and analyzer type used to any of the ST-765SS Series sensor channel inputs displayed on the OxiPanel PLUS.

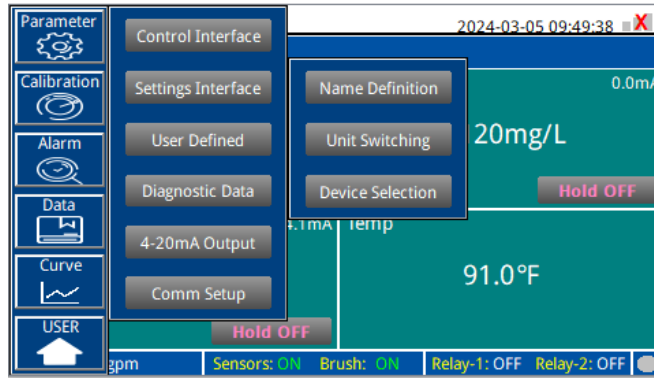

Figure. 36 – User Defined Settings

Parameter Name Definition

Click the orange dialog box to customize the sensor name.

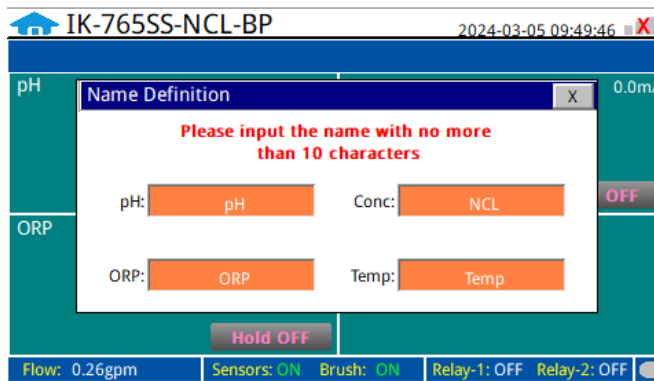

Figure. 37 - Name Definition

Unit of Measure Switching

Users can change the unit of temperature and flow rate in "Unit Switching".

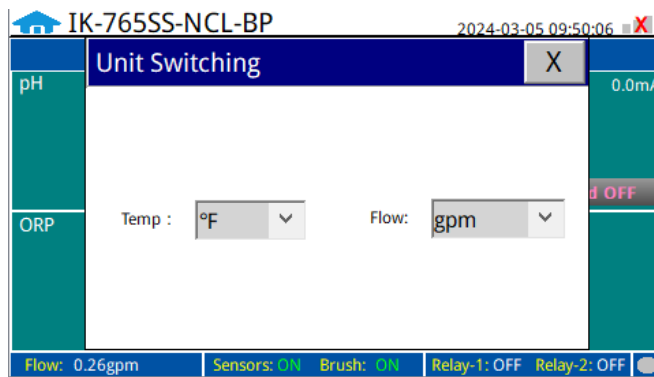

Figure. 38 - Unit Switching

Device Selection

The OxiPanel PLUS is shipped with the correct device selected, if an alternate sensor is desired due to application change, the new corresponding device can be selected here.

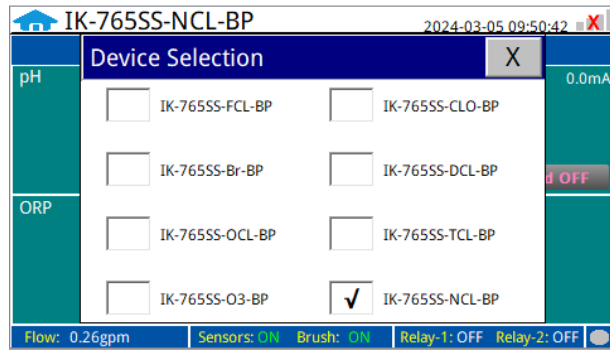

Figure. 39 - Device Selection

9.7.4. Diagnostic Parameters for Troubleshooting Support

Click **“Diagnostic Parameters”** to enter the diagnosis page. In the diagnosis page, the raw data measured by the probe is displayed. To help troubleshooting possible issues with the probe, please take an image of this data when the probe is placed in a clean water (tap water or deionized water), in a standard, and in the sample that the probe is intended for. These images may be sent to service@pyxis-lab.com for troubleshooting support.

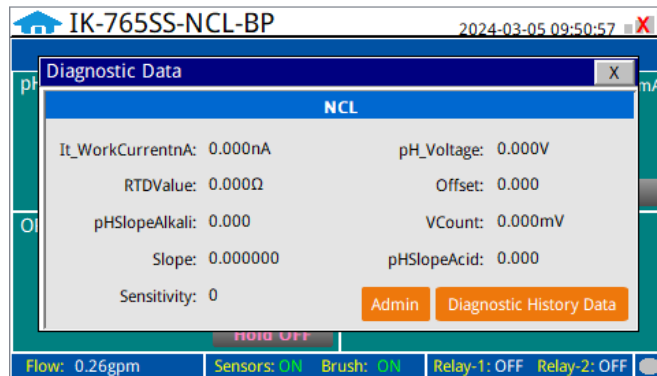

Figure. 40 - Diagnostic Parameters

Click on **“Diagnostic History Data”** in the lower right corner to access to view previous diagnostic parameters. Data can also be exported and made available for support from the Pyxis Lab Service Department.

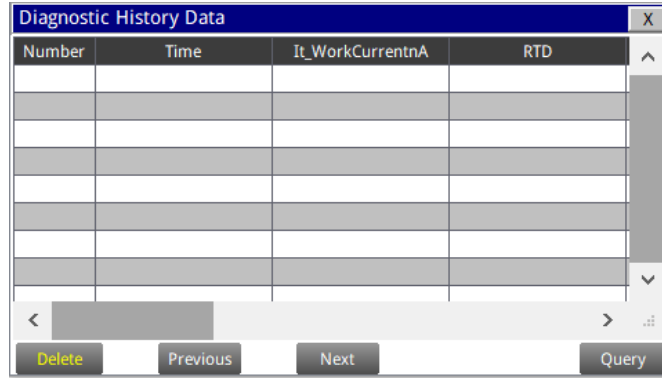

Figure. 41 - Diagnostic History Data

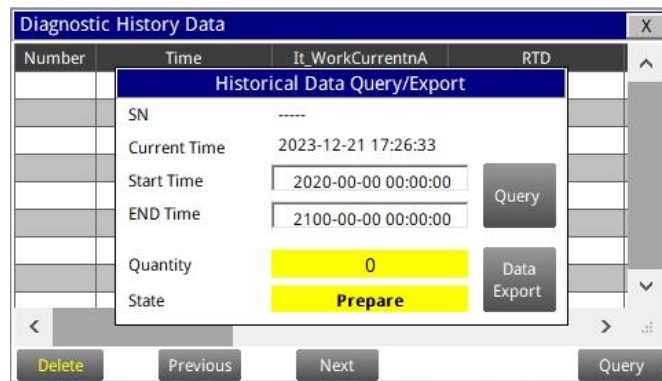

Figure. 42 - Diagnostic History Data Query

9.7.5. 4-20mA Output Parameter Settings & Adjustment

Click "**4-20mA Output**" to enter the 4-20mA output parameter setting interface. The 4mA and 20mA output values should correspond to the default lower and upper limits of the sensor range. These values may be adjusted by the user as desired. ****NOTE*** The closer the value is set to the measurement value the more accurate the data. It is recommended to set according to the range of the sensor.*

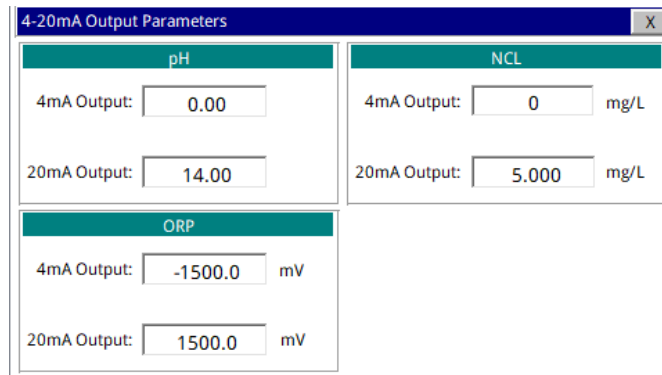

Figure. 43 - 4-20mA Output Setting

9.7.6. UC-80 Modbus Communication Settings

If the site desires to connect the UC-80 outputs to a DCS (Distributed Control System) for the purposes of information and process control, users can connect the master station device to the UC-80 through the HMI (Human Machine Interface) terminal and read the data according to the parameter register table provided in Section 10.1 of this manual)

Modbus RTU (RS-485) and **Modbus TCP** and **Ethernet Address** settings are preset but may be altered by the user as desired.

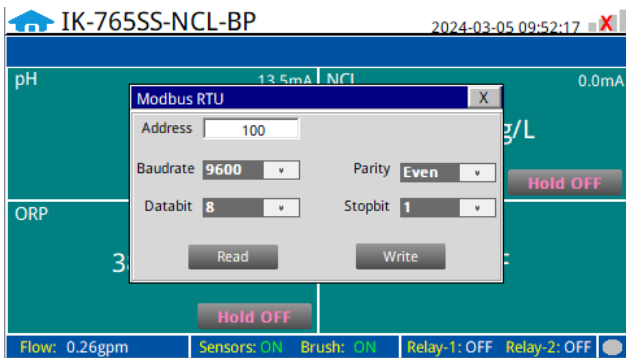

Figure. 44 - Modbus RTU

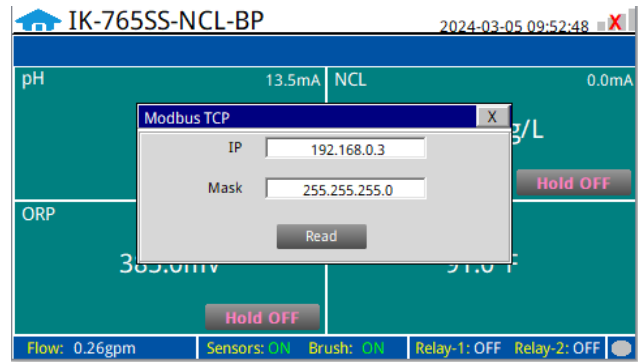

Figure. 45 - Modbus TCP

9.8. ST-765SS Series Sensor Calibration

Click on the "Calibration" button in the menu bar and select the sensor function desired for calibration.

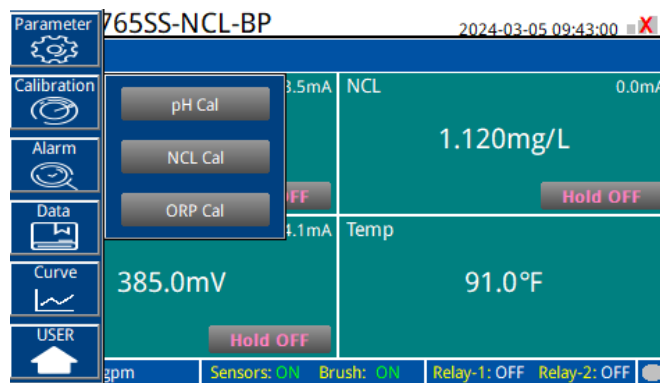

Figure. 46 - Sensor Calibration

9.8.1. pH Calibration

The pH function is thoroughly calibrated at the Pyxis Lab factory prior to shipment. After removing the sensor and checking it with a pH standard buffer solution in a beaker, if the sensor value has shifted, then the user may choose from single-point, two-point or three-point calibration to re-calibrate the pH portion of the ST-765SS sensor as desired. Pyxis Combo pH 4-7-10 Calibration Standard Kit (P/N:57007) or similar is suggested.

NOTE Click the Recovery button in the calibration interface of the sensor to restore the factory calibration settings if a user error is made during calibration and other operations. This will restore the factory settings of the sensor through this function.

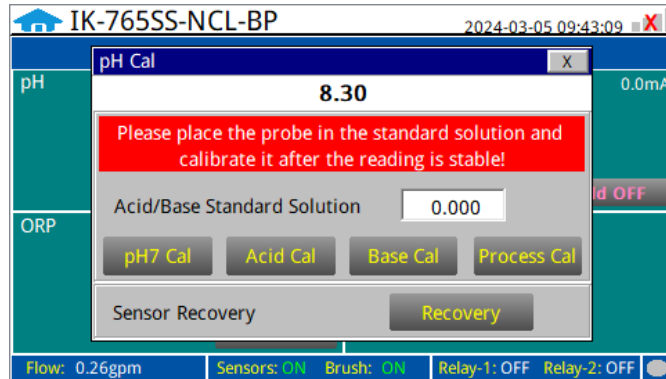

Figure. 47 - pH Calibration

Single Point pH Calibration

Remove the ST-765SS sensor and rinse 3x with DI water ensuring there is no debris or fouling of the sensor electrode head. Submerge the sensor into a beaker with pH=7 buffer solution. Click "**pH7 calibration**". A dialog box will pop up to confirm whether to perform this operation, click "**OK**" if the calibration operation is confirmed, if the calibration is successful the dialog box will show "**Calibration Success**".

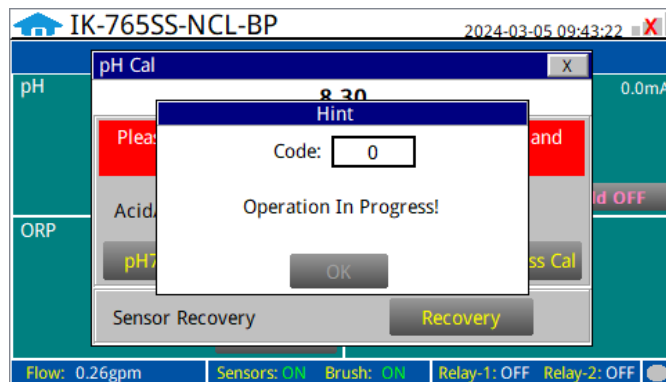

Figure. 48 - pH Calibration Prompt

A **Process Calibration** can be used if the pH calibration standard is not readily available for high, mid, and low calibration, or if there is a fixed deviation between the actual water sample and the true value after the user has done the calibration test. The pH process calibration is actually a correction (-0.5 to 0.5 pH units) made to the true pH value as measured by the sensor. Anything outside this range will require a formal calibration using pH calibration standard solution.

Two Point pH Calibration

Remove the ST-765SS sensor and rinse 3x with DI water ensuring there is no debris or fouling of the sensor electrode head. Submerge the sensor into a beaker with pH=7 buffer solution. Click "**pH7 calibration**". A dialog box will pop up to confirm whether to perform this operation, click "**OK**" if the calibration operation is confirmed, if the calibration is successful the dialog box will show "**Calibration Success**".

After pH7 is successfully calibrated, you can choose [Acid Calibration](#) or [Alkali Calibration](#) for the second calibration point. If you choose Acid Calibration, clean beaker 3x with deionized water. Fill the beaker with pH=4 buffer solution. Enter the value 4 in the calibration value dialog box, and click "**Acid Calibration**", then a dialog box will pop up to confirm whether to perform this operation. Click "**OK**" if the calibration operation is confirmed and the dialog box will show "**Calibration Successful**" if the calibration is successful. Similarly a pH=10 buffer solution can be selected for the second point calibration if desired.



Figure. 49 - pH Calibration Value Input

Three Point pH Calibration

Remove the ST-765SS sensor and rinse 3x with DI water ensuring there is no debris or fouling of the sensor electrode head. Submerge the sensor into a beaker with pH=7 buffer solution. Click "**pH7 calibration**". A dialog box will pop up to confirm whether to perform this operation, click "**OK**" if the calibration operation is confirmed, if the calibration is successful the dialog box will show "**Calibration Success**".

After pH7 is successfully calibrated, you can choose [Acid Calibration](#) or [Alkali Calibration](#) for the second calibration point. If you choose Acid Calibration, rinse the beaker 3x with deionized water. Fill the beaker with pH=4 buffer solution. Enter the value 4 in the calibration value dialog box, and click "**Acid Calibration**", then a dialog box will pop up to confirm whether to perform this operation. Click "**OK**" if the calibration operation is confirmed and the dialog box will show "**Calibration Successful**" if the calibration is successful.

After successful Acid Calibration, select pH=10 for Alkali Calibration. Rinse the beaker 3x with deionized water. Fill the beaker with pH=10 buffer solution. Enter the value 10 in the calibration value dialog box, and click "**Alkali Calibration**", then a dialog box will pop up to confirm whether to perform this operation. Click "**OK**" if the calibration operation is confirmed and the dialog box will show "**Calibration Successful**" if the calibration is successful. The three-point calibration is completed.

9.8.2. Oxidizer Calibration

The oxidizer measurement module of the ST-765SS sensor is thoroughly calibrated at the Pyxis Lab factory according to the specific oxidant being measured.

Single Point Oxidizer Calibration (In-Situ)

Use a portable or laboratory colorimeter (ie. Pyxis OxiPocket SP-200, Pyxis SP-800 or similar) to test the oxidizer concentration value of the active (flowing) water sample in the OxiPanel PLUS flow reservoir. Indophenol Method is recommended. Once you have tested and confirmed the oxidizer concentration value in the active (flowing) flow reservoir, enter the test result value of the colorimeter into the calibration screen in the **Process Calibration**. Please note, the label name of oxidizer being measured will be displayed in the upper left corner of this screen based on the model of OxiPanel PLUS and ST-765SS sensor format. Once the measured oxidizer value has been entered, click "**Process Calibration**". A dialog box will pop up to confirm whether to perform this operation. If the calibration operation is confirmed, click "**OK**", and if the calibration is successful, the dialog box will show "**Calibration Success**".

**NOTE* Click the Recovery button in the calibration interface of the sensor to restore the factory calibration settings if a user error is made during calibration and other operations. This will restore the factory settings of the sensor through this function.*

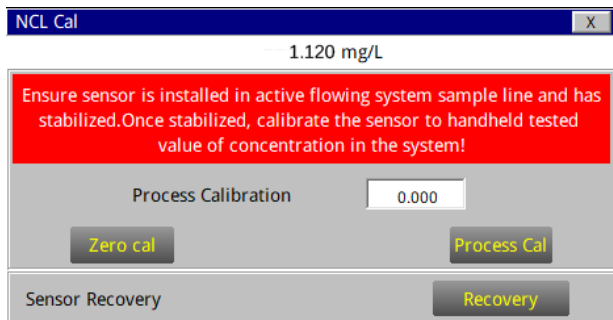

Figure. 50 –Oxidizer Calibration of ST-765SS-NCL

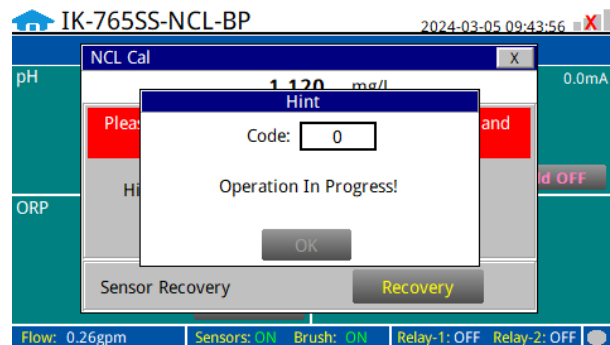

Figure. 51 – In Progress Screen of Oxidizer Calibration

Two Point Oxidizer Calibration

NOTE Under normal operational use of the ST765SS Series sensor, Pyxis Lab does not suggest a Zero-Point calibration by the user and the preprogrammed factory zero should remain unaltered. Only Slope calibration is recommended as a standard practice.

Zero-Point Calibration Procedure:

If a zero calibration is necessary, close the water inlet valve and remove the ST-765SS sensor and rinse 3x with DI water ensuring there is no debris or fouling of the sensor electrode head. Submerge the sensor into a beaker filled with Pyxis Zero Oxidizer Calibration Solution (P/N:21022) or with 100 μ S/cm Conductivity Standard Solution. Either will work. Wait for the ST-765SS sensor oxidizer value to stabilize on the touch-screen display. Sensor stabilization should occur within few minutes. Click "**Zero Calibration**" and a dialog box will pop up to confirm whether you desire to perform this operation. Click "**OK**" to confirm the calibration operation. If the calibration is successful, the dialog box will show "**Calibration Success**". The sensor is now zero-calibrated to the known zero calibration solution.

Slope-Point Calibration Procedure:

After successful zero calibration, insert the ST-765SS Series sensor back into the FR-300-PLUS and open the sample water supply valve allowing the sensor to read and stabilize after a few minutes of observation. Use a portable or laboratory colorimeter (ie. Pyxis OxiPocket SP-200, Pyxis SP-800 or similar) to test the oxidizer concentration value of the active (flowing) water sample in the OxiPanel PLUS flow reservoir. Indophenol Method is recommended. Once you have tested and confirmed the oxidizer concentration value in the active (flowing) flow reservoir, enter the test result value of the colorimeter into the calibration screen in the **Process Calibration**. Please note, the label name of oxidizer being measured will be displayed in the upper left corner of this screen based on the model of OxiPanel PLUS and ST-765SS sensor format. Once the measured oxidizer value has been entered, click "**Process Calibration**". A dialog box will pop up to confirm whether to perform this operation. If the calibration operation is confirmed, click "**OK**", and if the calibration is successful, the dialog box will show "**Calibration Success**".

NOTE Click the Recovery button in the calibration interface of the sensor to restore the factory calibration settings if a user error is made during calibration and other operations. This will restore the factory settings of the sensor through this function.

9.8.3. ORP Calibration

Close the water inlet valve and remove the ST-765SS sensor and rinse 3x with DI water ensuring there is no debris or fouling of the sensor electrode head. Submerge the sensor into a beaker filled with Pyxis ORP-200 Calibration Standard Solution (P/N: 57020) or similar. Enter the known concentration of the ORP standard solution in the calibration screen and click **“Calibrate”**. A dialog box will pop up to confirm whether to perform this operation. If the calibration operation is confirmed, click **“OK”**. If the calibration is successful, the dialog box will display **“Calibration Successful”**.

NOTE Click the Recovery button in the calibration interface of the sensor to restore the factory calibration settings if a user error is made during calibration and other operations. This will restore the factory settings of the sensor through this function.

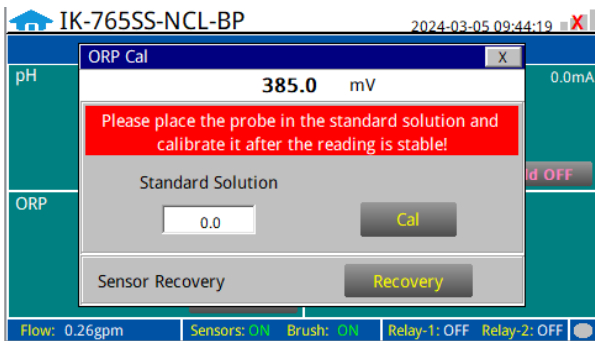

Figure. 52 - ORP Calibration

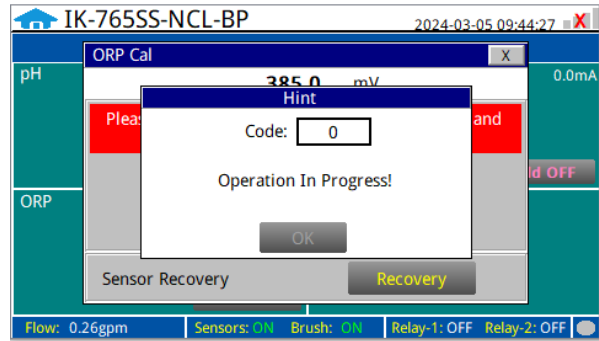

Figure. 53 - Awaiting Execution Screen

9.9. Alarm View

Click the **“Alarm View”** button on the main screen to enter the alarm view screen.

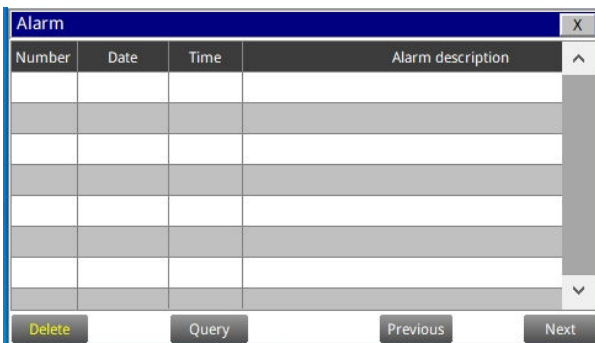

Figure. 54 - Alarm View

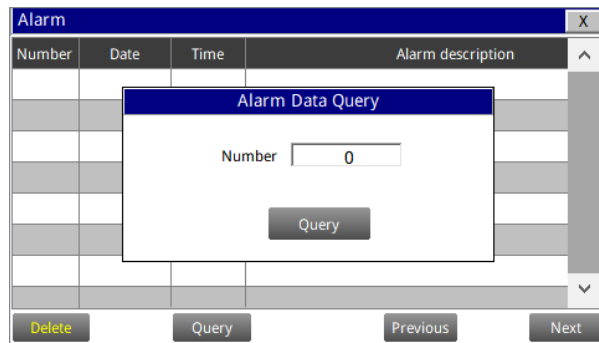

Figure. 55 - Alarm Data Query Screen

In this screen users can browse all logged alarms. Drag the right scroll bar up and down to view the history of alarms. Click **“Previous”** and **“Next”** to advance to the next page. Click **“Query”** then enter the alarm number in the pop-up box to query that alarm. The Delete button in the lower left corner will delete all alarm records. After clicking delete, you must exit the screen and reenter before the historical data within the data report will be cleared.

9.10. Historical Data – Query, View & USB Download

Click on "Data" to view historical data and calibration logs.

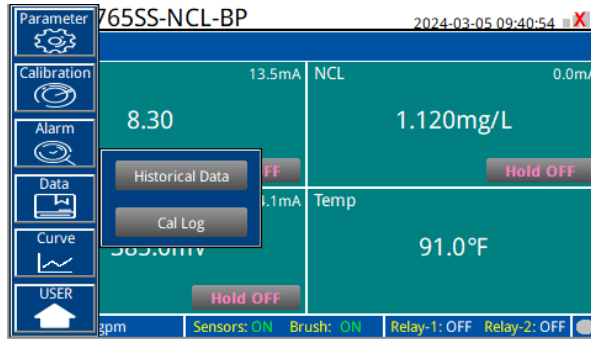

Figure. 56 - Data

Historical Data

Click the "Historical Data" button in the menu bar to enter the data report interface.

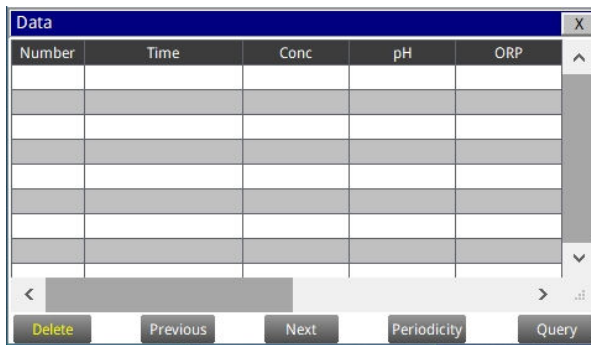

Figure. 57 - Historical Data Screen

In the data report, the user can view the stored data of all parameters. The system records sensor readings every 4 seconds by default but this can be edited by the user if desired. Drag the scroll bar on the right to slide up or down or click "Previous" and "Next" to view historical data records. The data record can save up to 100,000 data entries. New data will overwrite the previously saved data after recording 100,000 data entries. The user can click the "Periodicity" button to change the data recording time interval. Click "Delete" in the lower left corner. After entering the retention time, click the "Delete" button to clear all historical data within the retention time range.

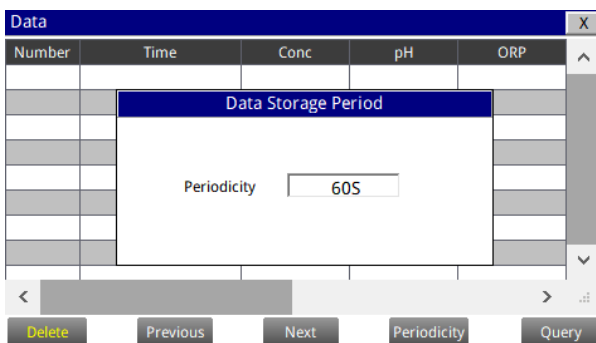
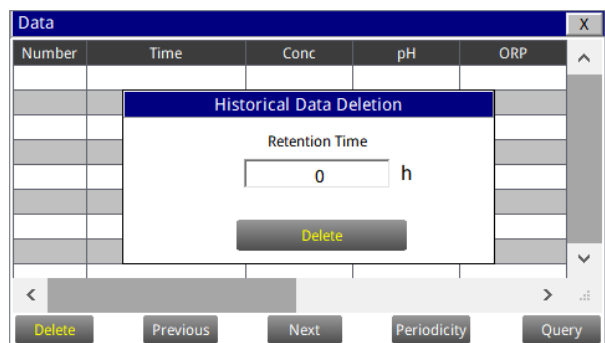

Figure. 58 - Data Storage Cycle Time Setting Figure.



59 - History Data Deletion Screen

Click the “**Query**” button in the lower right corner, enter the start time and end time and then click the “**Query**” button. ***NOTE*** The start time and end time must be filled in exactly and completely according to the system time format of Year / Month / Day / Hours / Minutes / Seconds.

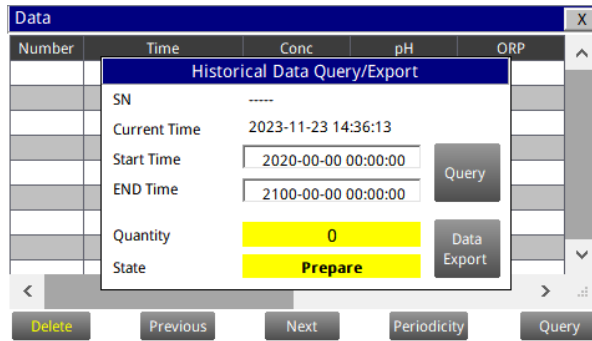

Figure. 60 - Historical Data Query and Export Screen

Insert a USB disk behind the HMI display screen and enter the time range of the data to be exported in the query area. Click on the “**Data Export**” to download the data to the USB disk. The data quantity will be shown as a positive number if data export is successful. If the data export was not successful, please check whether the time format is correct. ***NOTE*** Please be sure to use and empty (no saved files) FAT32 formatted USB disk with data capacity of 32-64GB.

When a **Quantity** value appears, refer to the following table to troubleshoot the issue.

Quantity	Description
-1001	Progress or control data object type is incorrect
-1004	Group object name does not exist or the group object does not have the save property
-1020	The start time of the export is greater than the end time
-1021	USB flash drive is not inserted
-1022	Only one export task is allowed at the same time
-1023	The number of records read is 0
-1024	File operation failed
-1025	Export path is empty
-1026	Export path is not legal
-1027	Incorrect time format
-1028	Unsupported export mode

Calibration Log

The calibration log can be viewed in the calibration log interface, and when the export operation is performed, the diagnostic parameters, historical data, and calibration log will be exported simultaneously.

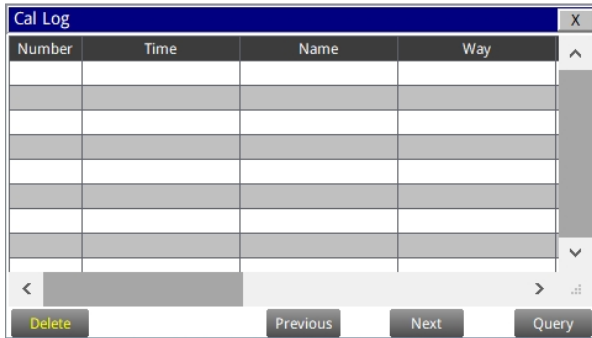

Figure. 61 - Calibration Log

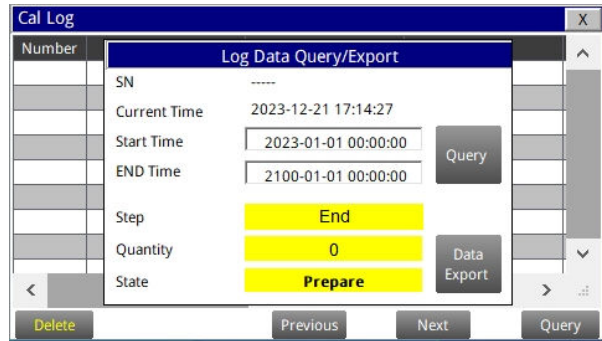

Figure. 62 - Calibration Log Query/Export

9.11. Historical Data Curves

Click the "Historical Curve" button in the menu bar to enter the trend curve interface. You can click the buttons below the X-axis to browse and view the values in a different time range. Click on Y-axis Range to change the minimum and maximum Y-axis values for a proper range.

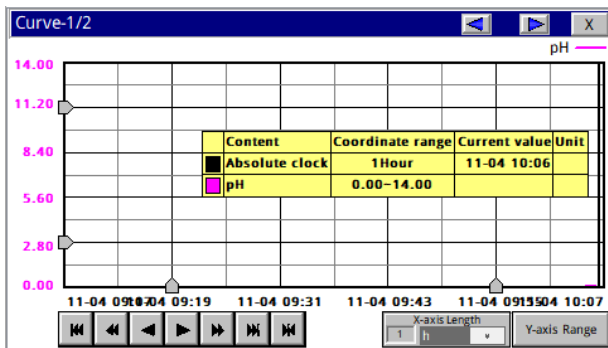

Figure. 63 - History Curve Screen 1-2

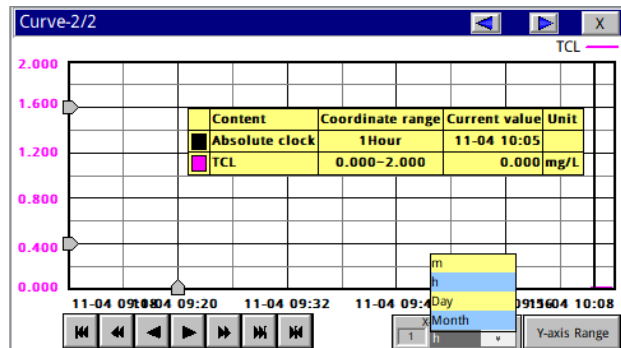

Figure. 64 - History Curve Screen 2-2

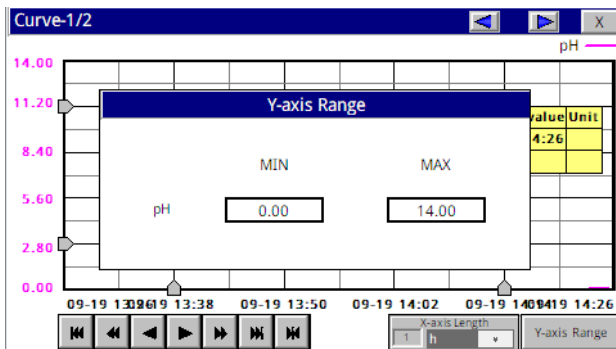

Figure. 65 - Y-axis Range Setting 1-2

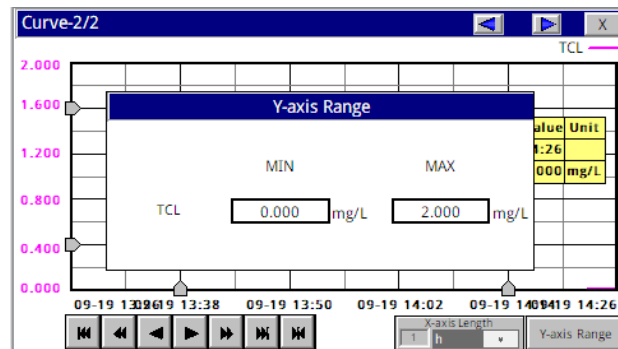

Figure. 66 - Y-axis Range Setting 2-2

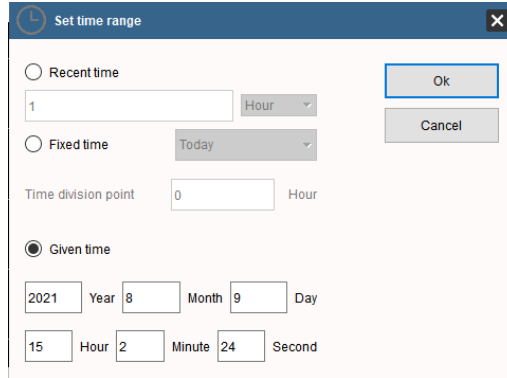

Figure. 67 - Time Setting Screen

Please refer to the button description overview for Historical Curve Function navigation.

- ⏪ The curve will scroll back (to the left of the X-axis) one page
- ⏩ The curve will scroll back (to the left of the X-axis) half the page of the curve
- ⏴ The curve will scroll backward (to the left of the X-axis) to a position where the main line is drawn
- ⏵ The curve will scroll forward (to the right of the X-axis) to a position where the main line is drawn
- ⏪ The curve will scroll forward (to the right of the X-axis) half the page of the curve
- ⏩ The curve will scroll forward (to the right of the X-axis) one page
- ⏪ The curve will scroll forward (to the right of the X-axis) one page
- ⏪ A dialog box will pop up to reset the starting time of the curve

Figure. 68 - Button Function Review

9.12. User Management

Click the "User" button on the menu bar and then you can select "Login", "Logout" and "Manage" operations.

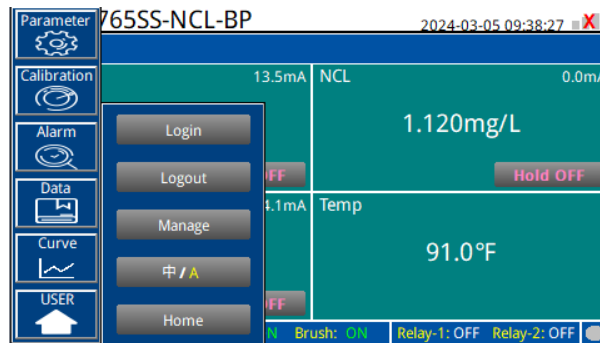

Figure. 69 - User Management

Logout enables the user to log out of the logged-in state and only view the real-time readings, but cannot perform operations such as parameter settings. Click **“Manage”** to enter the user management interface, where you can add users, change passwords and other operations. Users can set their own user name and password and select the user group they belong to. Only users in the administrator group can set parameters such as calibration.

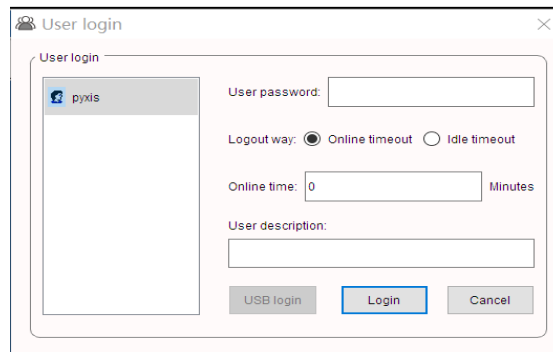

Figure. 70 - Modifying the User Screen

Modify Password: Select the user you want to change, then click **“Modify User”** button, enter the user's own password in the User Password column and Confirm Password column, and click **“Confirm”** to modify successfully.

NOTE If you do not want to set the password, you can delete the password and save it.

10. Modbus Register Table & Analyzer Maintenance

10.1. Modbus Correspondence Address

Serial Number	Definition	Address	Format	Mode	Unit	Note
1	Oxidizer Concentration 1	1	float	read-only	mg/L	Data Format ABCD
2	pH	3	float	read-only		
3	ORP	5	float	read-only	mV	
4	Temperature	9	float	read-only	°F	
5	Flow Rate	11	uint	read-only	mL/min	
6	Concentration1 Lower Limit Alarm	13	uint	read-only		0: Normal 1: Alarm
7	Concentration 1 Upper Limit Alarm	14	uint	read-only		
8	pH Lower Limit Alarm	15	uint	read-only		
9	pH Upper Limit Alarm	16	uint	read-only		
10	ORP Lower Limit Alarm	17	uint	read-only		
11	ORP Upper Limit Alarm	18	uint	read-only		
12	Concentration Sensor Communication Abnormal	21	uint	read-only		
13	Relay Module Communication Abnormal	22	uint	read-only		
14	Flow Rate Acquisition Module Communication Abnormal	23	uint	read-only		
15	Brush Communication Abnormal	24	uint	read-only		
16	Analog Module Mommunication Abnormal	25	uint	read-only		
17	Brush Failure	26	uint	read-only		
18	Low Flow Alarm (<50mL/Min)	27	uint	read-only		
Communication Protocol: Standard Modbus-RTU						
Communication Parameters: Baud Rate - 9600 / Data Bit - 8 / Stop Bit -1 / Parity Bit - Even						
Station Number: 100						
Communication Protocol: Standard Modbus-TCP						
Communication Parameters: IP: 192.168.0.3 (can be set); port: 502						
Station Number: 1						

Table. 1 - Modbus Correspondence Address

10.2. Analyzer Operation and Maintenance

After the analyzer is installed by a qualified technician, it can begin to monitor water quality immediately. Upon powerup of the analyzer, the ST-765SS Series sensor will always conduct a 5-minute electrode initialization process to prepare the bare-gold for service. During this time, the sensor will not read an oxidizer value. After this cycle, the sensor will begin reading the live oxidizer value. The OxiPanel PLUS is designed to be simple to operate, but still requires some regular maintenance. Actual system maintenance may vary depending on the installation conditions and usage. Please refer to the table below as a general recommended maintenance schedule guideline. Little operator intervention is required during normal operation.

Required Services	Recommended Frequency	Procedure Location
Cleaning Inlet Water Filter Screen	Monthly or Cleaned As Needed	NA
Cleaning of Flow Reservoir & Electrode Head	Monthly or Cleaned As Needed	Section 11.3
pH Calibration	Every 6 Months or As Needed	Section 9.8.1
Oxidizer Calibration	Every 6 Months or As Needed	Section 9.8.2
ORP Calibration	Every 6 Months or As Needed	Section 9.8.3
FR-300-PLUS Brush Replacement	Every 1-2 Years or As Needed	Section 11.1
EH-765 Electrode Head Replacement	Every 1-2 Years or As Needed	Section 11.2

Table. 2 - Maintenance Intervals

10.3. Instrument Alarms and Descriptions

Please refer to the instrument alarms and descriptions table when troubleshooting the IK-765SS-BP inline inspection system issues an alarm or indicates abnormal measurement data.

Alarms	Description	Symptoms	Solutions/Recommendations
pH / Oxidizer Sensor Communication Abnormalities	pH / Oxidizer Sensor without Communication	No pH and Oxidizer Measurements	Check the connection between the sensor and the circuit board. If the problem persists, contact Pyxis.
pH Upper Limit Alarm	pH above the Alarm Setting	Information Only	Compare with manual measurement readings. Check and clean line valves. Check that water flow is normal. Check that the sensor is clean.
pH Lower Limit Alarm	pH below the Alarm Setting	Information Only	
Oxidizer Upper Limit Alarm	Oxidizer above the Alarm Setting	Information Only	
Oxidizer Lower Limit Alarm	Oxidizer below the Alarm Setting	Information Only	
pH/Oxidizer Calibration Failure Code 2		Calibration Failure	Check whether the water flow is normal, whether the sensor is clean, whether the standard liquid is contaminated
pH/Oxidizer Calibration Failure Code 3	Standard Solution Value out of Range	Calibration Failure	
pH/Oxidizer Calibration Failure Code 5	Wrong Data Type for the Liquid Value	Calibration Failure	

Table. 3 - Common Alarms

11. Replacement Maintenance

11.1. Replacing the FR-300-PLUS Brush Assembly

Under normal application use, the FR-300-PLUS brush replacement should be done every 2-years. This may vary depending on application and water quality. Please refer to the following process steps for replacement of the FR-300-01 (P/N : 50700-A49) brush assembly.

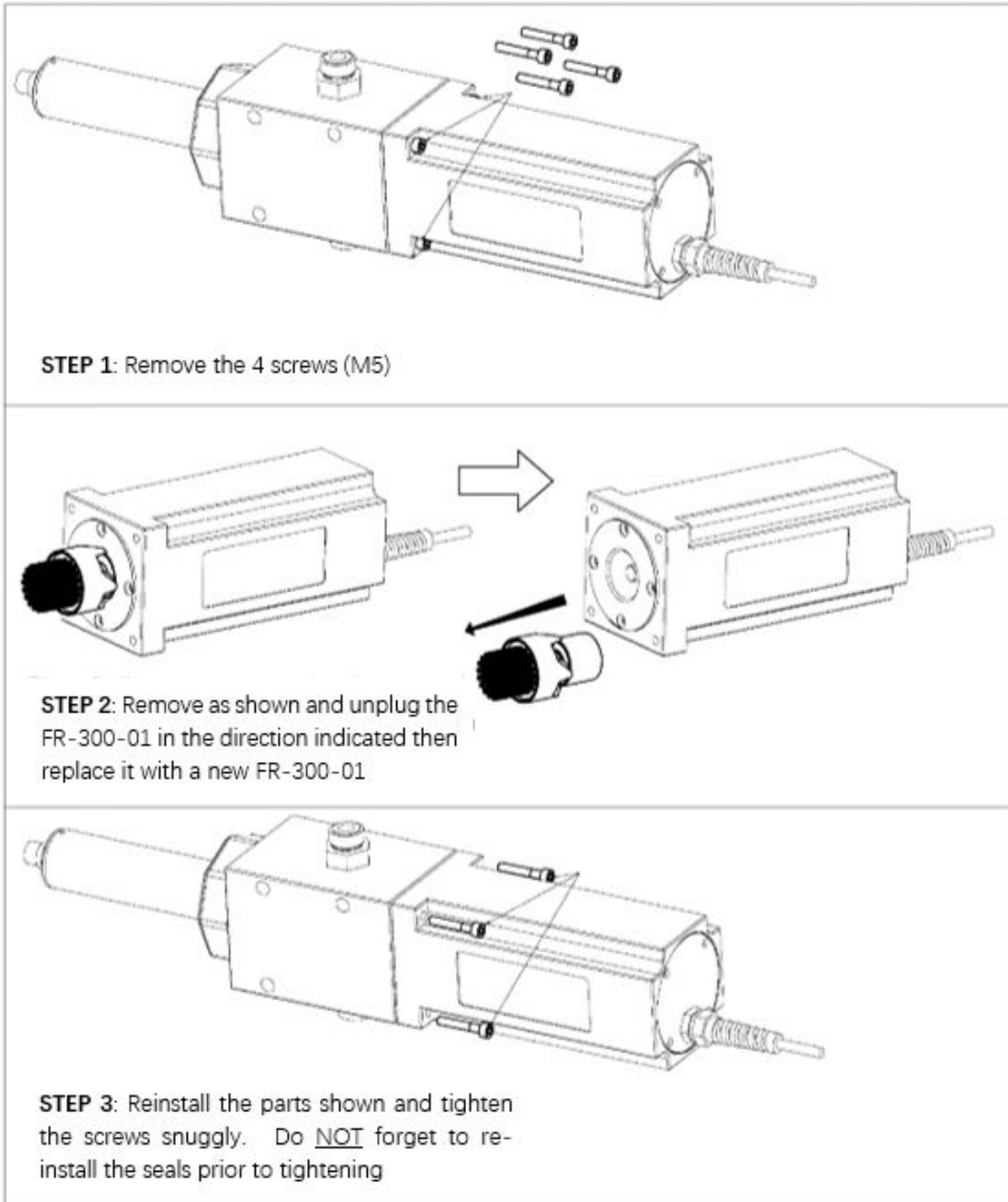

11.2. Replacing pH and Oxidizer Electrode Head

The EH-765 electrode head (P/N: 53061) of the ST-765SS Series sensors can be replaced when the original electrode heads have reached the end of their working life. The typical working life of the electrode can be as long as 2-years under normal operating conditions. Please refer to the following steps to replace the electrode head of your sensor.

1. Place sensor power in Flow Interlock Manual Mode and then Power OFF the sensor (see Section 9.7.1) remove and make sure there is no water on the sensor.
2. Hold the sensor main body with one hand and use the other hand to twist the locking ring counterclockwise until the front end of the black electrode is completely unscrewed, as shown in Figure 71-2. ***NOTE* The sensor electrode head should be oriented towards the ground to avoid residual water getting into the sensor.**
3. Thoroughly wipe the electrode head with a dust-free cloth or paper-towel then pull out the electrode head as shown in Figure 71-3.
4. Gently loosen the electrode plug connector and remove the electrode head, as show in Figure 71-4.
5. To install the new electrode head, please use the mounting hook to securely plug in the wiring connector, as shown in Figure 71-5. ***NOTE* Before connecting the electrode head, please make sure that the new electrode head gasket is properly installed at the base of the electrode head thread to ensure a watertight seal, as shown in Figure 71-5.**
6. Then reconnect, insert the new electrode head into the main sensor housing and ensure that the two alignment protrusions on the electrode head are aligned with the notches in the sensor body housing, as shown in Figure 71-6. Then twist the lock ring of sensor in a clockwise direction until the threads of the electrode head completely enter the sensor housing as shown in Figure 71-1. ***NOTE* Be sure to return your sensor operation to Flow Interlock Auto Mode (Section 9.7.1)**



Figure. 71 - Replacing EH-765 pH and Oxidizer Electrode Head

11.3. Sensor Cleaning with Pyxis Probe Cleaning Kit

In the event of heavy inorganic deposition on the ST-765SS Series electrode head, users may conduct an off line chemical cleaning using the Pyxis Probe Cleaning Kit (P/N: SER-01). Isolate the FR-300-PLUS flow reservoir from flow. Remove the ST-765SS Series sensor from the reservoir and inspect the internal components of the flow reservoir and brush head with a flash light. If necessary flush thoroughly with clean water until adequately clean. If the FR-300-PLUS brush is in need of replacement, refer to Section 11.1 of this manual. Soak the lower half of the ST-765S Series sensor in 100 mL Pyxis Probe Cleaning Solution for 10-15 minutes. Gently wipe the sensor electrode head with the provided Q-tips. If the surface is not entirely clean, continue to soak the sensor for an additional time until clean. Rinse the sensor with distilled water. Pyxis Lab Probe Cleaning Kit can be purchased at our online Estore/Catalog at <https://www.pyxis-lab.com/product/inline-sensor-cleaning-kit/>



Contact Pyxis Lab

21242 Spell Circle

Tomball, TX. 77375

service@pyxis-lab.com for technical service and support

order@pyxis-lab.com for order and pricing inquiries

1-866-203-8397 Phone USA for all needs

Office Hours 7AM – 5PM Central Time USA