

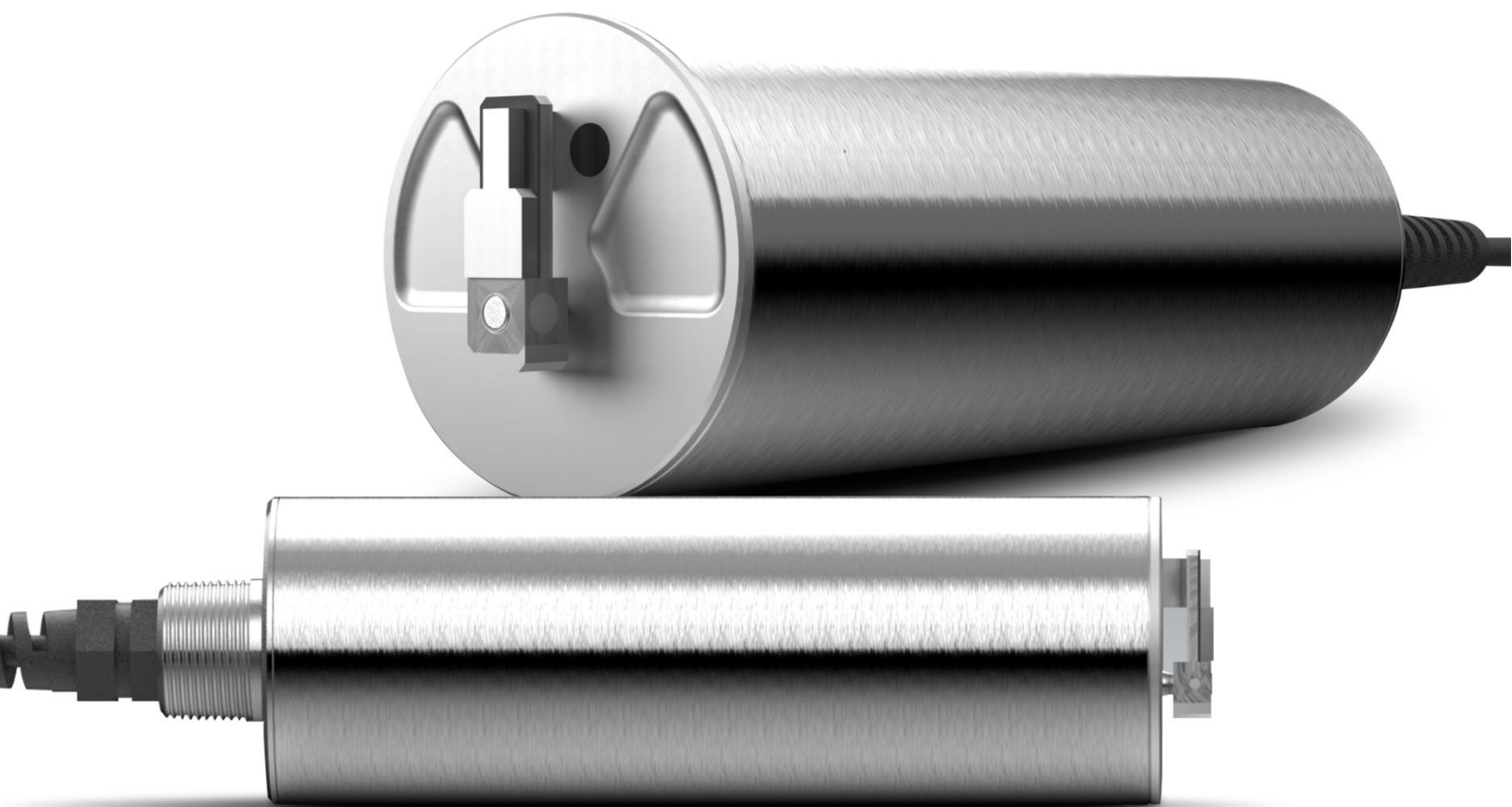

[LT-630, LT-632, LT-633]

LT-63X Series Turbidity Sensors

Auto-Wiping & Submersible Sensors



Pyxis Lab® Inc.

1729 Majestic Dr. (Suite 5)

Lafayette, CO 80026

www.pyxis-lab.com

USER MANUAL

Warranty Information

Confidentiality

The information contained in this manual may be confidential and proprietary and is the property of Pyxis Lab, Inc. Information disclosed herein shall not be used to manufacture, construct, or otherwise reproduce the goods described. Information disclosed herein shall not be disclosed to others or made public in any manner without the express written consent of Pyxis Lab, Inc.

Standard Limited Warranty

Pyxis Lab warrants its products for defects in materials and workmanship. Pyxis Lab will, at its option, repair or replace instrument components that prove to be defective with new or remanufactured components (i.e., equivalent to new). The warranty set forth is exclusive and no other warranty, whether written or oral, is expressed or implied.

Warranty Term

The Pyxis warranty term is thirteen (13) months ex-works. In no event shall the standard limited warranty coverage extend beyond thirteen (13) months from original shipment date.

Warranty Service

Damaged or dysfunctional instruments may be returned to Pyxis for repair or replacement. In some instances, replacement instruments may be available for short duration loan or lease.

Pyxis warrants that any labor services provided shall conform to the reasonable standards of technical competency and performance effective at the time of delivery. All service interventions are to be reviewed and authorized as correct and complete at the completion of the service by a customer representative or designate. Pyxis warrants these services for 30 days after the authorization and will correct any qualifying deficiency in labor provided that the labor service deficiency is exactly related to the originating event. No other remedy, other than the provision of labor services, may be applicable.

Repair components (parts and materials), but not consumables, provided during a repair, or purchased individually, are warranted for 90 days ex-works for materials and workmanship. In no event will the incorporation of a warranted repair component into an instrument extend the whole instrument's warranty beyond its original term.

Warranty Shipping

A Repair Authorization (RA) Number must be obtained from Pyxis Technical Support before any product can be returned to the factory. Pyxis will pay freight charges to ship replacement or repaired products to the customer. The customer shall pay freight charges for returning products to Pyxis. Any product returned to the factory without an RA number will be returned to the customer. To receive an RMA you can generate a request on our website at <https://www.pyxis-lab.com/request-return-or-repair/>

Pyxis Technical Support

Contact Pyxis Technical Support at +1 (866) 203-8397 or service@pyxis-lab.com

Table of Contents

1 Introduction	4
1.1 Features	4
1.2 Specifications	5
1.3 Unpacking the Pyxis LT-63X Series Sensor	5
1.4 Standard Accessories	6
1.5 Optional Accessories	6
2 Quick 4-20mA Start	7
3 Installation	8
4 Calibration and Diagnosis	10
4.1 Calibration and Diagnosis by uPyxis Mobile APP	10
4.1.1 Calibration.....	11
4.1.1.1 Deionized Water Calibration.....	12
4.1.1.2 Mid-Range Calibration	12
4.1.1.3 High-Range Calibration	13
4.1.2 Restore to Factory Calibration Settings	14
4.1.3 Diagnosis	15
4.1.4 Cleaning Period Adjustment	16
4.2 Calibration and Diagnosis by uPyxis Desktop APP	17
4.2.1 Calibration.....	20
4.2.1.1 Deionized Water Calibration.....	21
4.2.1.2 Mid-Range Calibration	21
4.2.1.3 High-Range Calibration	22
4.2.2 Restore to Factory.....	23
4.2.3 Diagnosis	24
4.2.4 Cleaning Period Adjustment	24
5 Modbus RTU	25
6 Sensor Cleaning and Maintenance	25
7 Sensor Wiper Replacement Instructions	26
8 Contact Us	27

1 Introduction

The LT-63X series sensor platform (including the LT-631, LT-632 and LT-633) are submersible, waterproof, self-cleaning sensors utilize dual wavelength detection technology to measure turbidity in the ranges of 0 to 4000 NTU. The sensor automatically compensates for disturbances caused by flow fluctuations, climate change, color change or changes in turbidity. The instrument design is virtually maintenance-free, and the self-cleaning capability of the sensor prevents deviations caused by air bubbles and suspended solids particulate. It is powered by a 24 VDC/6W power supply and offers fully integrated 4-20 mA and RS-485 Modbus output signals for connection to any controller, PLC or DCS network. When clean, the unique Pyxis sensor design offers a stability of <0.1 NTU for up to 1-year without calibration. Additionally, this sensor platform can be accessed via the MA-CR Bluetooth/USB adapter for local display, diagnostics, auto-wiper programming, sensor cleaning and calibration when using the uPyxis APP for mobile or desktop devices. The LT-63X series sensor is ideal for use in raw water, surface water, storm water, process water and discharged water applications.

1.1 Features

The LT-63X Series sensor includes the following features:

- Resolution as low as 0.1 NTU
- Built-in transmitter, without preamplifier or meter head
- Combination 4-20mA isolated signal and RS-485 Modbus (RTU) output
- Simple / Wireless calibration using uPyxis Mobile or Desktop APPs and MA-CR Bluetooth Adapter
- Supports self-cleaning of sensor lens for dirty water applications
- Optional calibration with Pyxis Formazin calibration standards or field water samples
- ¾-inch MNPT Threaded For Fixed Submersion

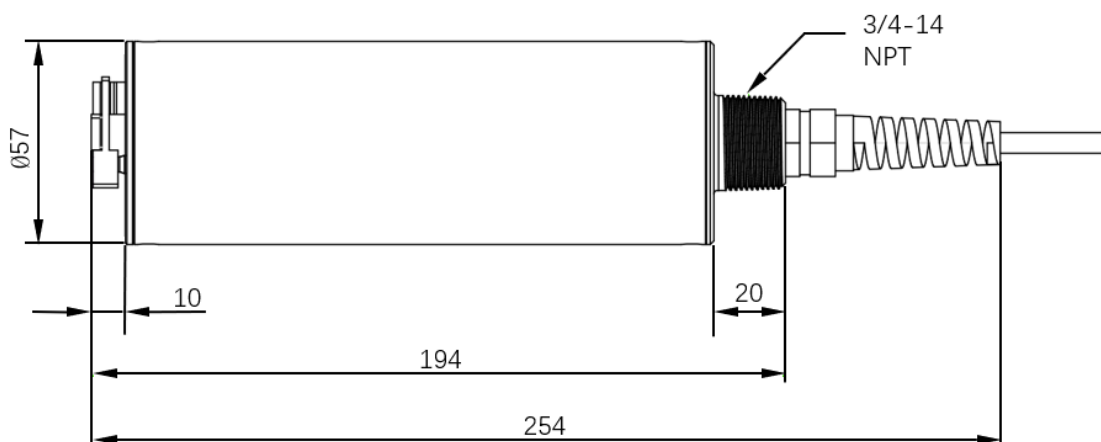

Figure 1 LT-63X Series Dimensions (mm)

1.2 Specifications

Item	LT-631	LT-632	LT-633
P/N	53249	53250	10002
Parameter	Turbidity		
Measurement Range (4-20mA Output Scale)	0.00 – 500.00	0.00 – 1000.00	0.00 – 4000.00
Unit of Measure	NTU <i>Nephelometric Turbidity Unit</i>		
Lower Detection Limit	0.5NTU		
Precision (Tested in Formazin standard solution (25°C))	<100 NTU: ±3% of reading or 2 NTU >100 NTU: ±10% of reading		
Resolution	0.1NTU		
Response Time	T95<12 Seconds		
Calibration Method	Field Tested Process Sample or Formazin Calibration Standard		
Dual Wavelength	Warm White Light <100NTU / Infrared Light >100NTU		
Method	Scattering		
Power Supply	22 – 26VDC 6W		
Operating Temperature	32 – 122 °F (0-50 °C)		
Storage Temperature	-7 °C – 60 °C (20 – 140 °F)		
Outputs	Isolated 4 – 20 mA Analog Output & Isolated RS-485 Digital Output		
Installation	Submersed – Fixed Conduit ¾-inch MPNT Threaded Cable Fitting Submersed – Hoisting Chain or Cable Sensor Distance from Bottom of Vessel (>15cm) Sensor Distance from Sides of Vessel (>10cm)		
Material	316 Stainless Steel – Body & Wiper Arm PTFE – Wiper Blade		
Weight	1,530 g (3.3 lbs)		
Operational Pressure	45 psi (3.1 Bar)		
Rating	IP-68, Fully Dustproof & Waterproof		
Regulation	CE / RoHS		
Dimension (L x W x H)	(254mm x 57mm x 57mm)		
Cable Length	33 feet (10m) w/IP-67 8-Pin adapter 4.9 feet (1.5m) flying lead w/IP-67 8-Pin adapter (Extension Cables Also Available)		

***Note*:** Pyxis Lab specifications are subject to change without notice

1.3 Unpacking the Pyxis LT-63X Series Sensor

Remove the instrument and accessories from the shipping container and inspect each item for any damage that may have occurred during shipping. Verify that all items listed on the packing slip are included. If any items are missing or damaged, please contact Pyxis Customer Service at service@pyxis-lab.com

1.4 Standard Accessories

The following accessories are included in the LT-63x sensor package.

LT-631 (P/N 53249) or LT-632 (P/N 53250) or LT-633 (P/N 10002) sensor will include the following:

- One bulkhead terminated cable w/8-Pin Female Adapter (33 feet / 10m)
- One MA-1.5CR Flying Lead Cable w/8-Pin Male Adapter/Flying Lead (4.9 feet / 1.5m)
- One MA-CR Bluetooth / USB Adapter
- The full instrument manual is available for download at www.pyxis-lab.com/shop/

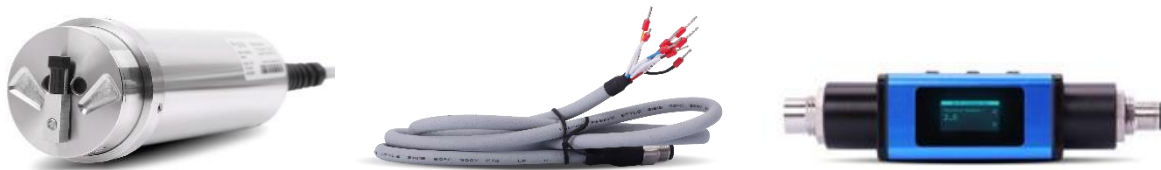

Figure 2 - LT-63X Series Sensor with 10m Terminated Cable + 1.5m Flying Lead Cable (MA-1.5CR) + MA-CR Bluetooth/USB Adapter

1.5 Optional Accessories

The following optional accessories can be purchased order@pyxis-lab.com or www.pyxis-lab.com/shop/

Accessory Name	Item Number
LT-63x Replacement Wiper Blade/Arm Assembly Kit <i>(Includes 5 sets of Wiper Blade with Arm)</i>	50700-A50
MA-CR <i>(Bluetooth Adapter/Display For use with Pyxis 8-Pin Sensors)</i>	MA-CR
MA-120-B Fixed Submersion Adapter Bracket <i>(Submersed Fixed Installation Mounting Bracket)</i>	50783
MA-50CR <i>(50' Extension Cable w/8Pin Adapters)</i>	50743
MA-100CR <i>(100' Extension Cable w/8Pin Adapters)</i>	50744
Formazin Turbidity Calibration Standard – 100 NTU <i>(4,000 mL)</i>	57010-100L
Formazin Turbidity Calibration Standard – 500 NTU <i>(4,000 mL)</i>	57010-500L
Formazin Turbidity Calibration Standard – 1,000 NTU <i>(4,000 mL)</i>	57010-1000L

2 Quick 4-20mA Start

Follow the wiring table below to connect the LT-63x series sensor to a controller or PLC. ***NOTE*** All Pyxis sensors provide a passive 4-20mA output signal, they are NOT LOOP POWERED. 24VDC+ power supply and 4-20mA+ signal are independent of each other in all Pyxis Lab sensors.

Wire Color	Designation
Brown	Power GND
Green	RS-485 C
Yellow	RS-485 B
Gray*	4-20mA - (Internally connected to power ground)
Pink	Not Used
Blue	RS-485 A
White	4-20mA + (Turbidity NTU)
Red	24V+
Silver	PE

NOTE The 24V- power ground (brown) and the 4-20 mA- (gray) return are internally connected. If the 24V- power ground and the 4-20 mA return in the controller are internally connected (non-isolated 4-20mA input), it is unnecessary to connect the 4-20 mA- (gray wire) to the 4-20 mA negative terminal in the controller. If a separate DC power supplier other than that from the controller is used, make sure that the output from the power supply is rated for 22-26 VDC @ 250mA.

Please refer to the table below for proper LT-63X output 4-20mA scaling in your receiving display, controller or PLC.

LT-63x Series Output Scaling (4-20mA)			
mA	LT-631	LT-632	LT-633
4	0 NTU	0 NTU	0 NTU
20	500 NTU	1000 NTU	4000 NTU

3 Installation

Submersed Fixed Installation with MA-120-B: The LT-63X series sensor may be installed in a submersed/fixed application using the MA-120-B Submersion Adapter Mounting Bracket (P/N: 50783). The LT-63X series sensor should be installed as outlined in and 3A. For installation, the MA-120-B bracket should permanently mounted in a fixed position for easy access to the LT-63X series sensor and piping. For sensor replacement and maintenance, users only need to lift (vertically/upwards) the sliding block and conduit with the mounted sensor from MA-120-B bracket. ***NOTE*** The LT-63X series sensor should be installed with a minimum distance of >15cm from the bottom of water vessel to the lens of the sensor and a minimum of >10cm from the vessel wall on all sides. Please note the LT-63X series outer diameter is ¾ - inch NPT. A ¾ to 1-inch NPT bushing is required for installation.

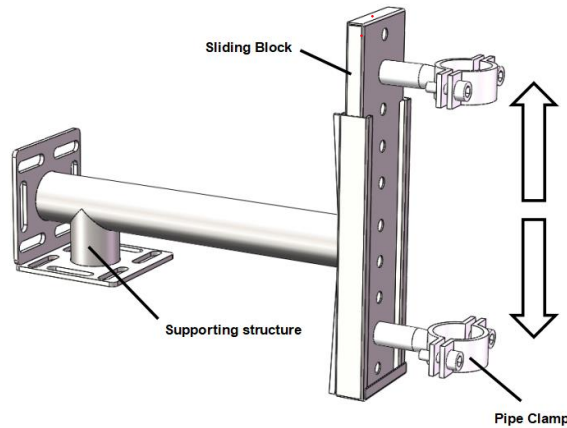

Figure 3 – MA-120-B Submersion Adapter Mounting Bracket

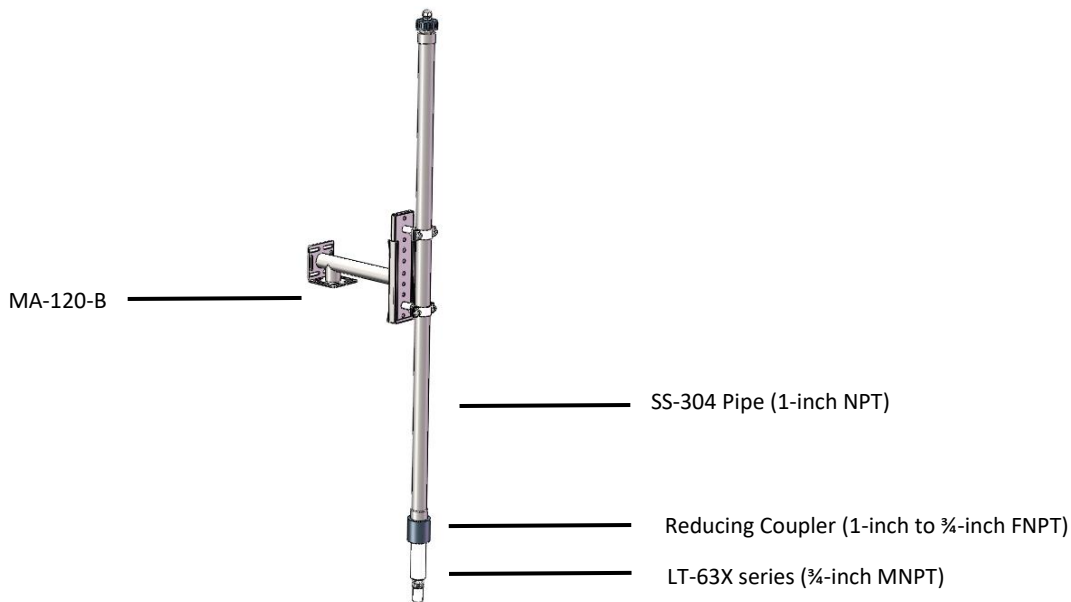

Figure 3A - Installation Using MA-120-B Submersion Bracket with Piping

Submersed Installation with Lifting Ring: The LT-63X series sensor comes equipped with a lifting ring which allows the sensor to be lifted and lowered using a user provided chain or cable. For this method of installation and use, please refer to

Figure . For sensor replacement and maintenance, users only need to lift the chain or cable and LT-63X series sensor vertically (upwards).

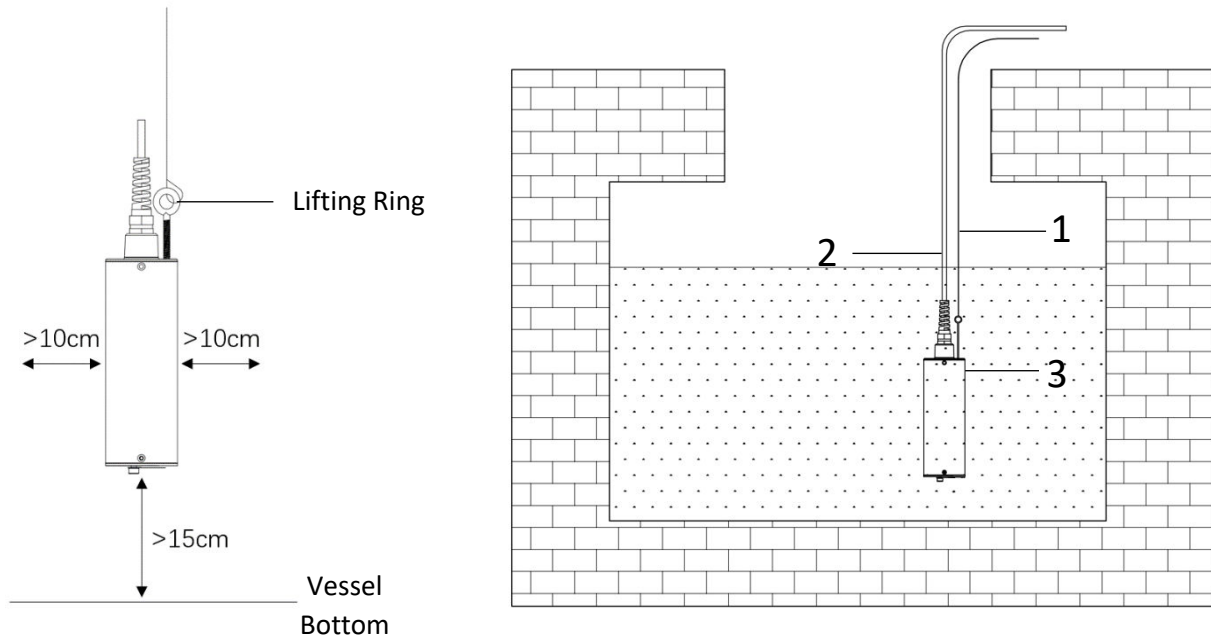

Figure 4 - Submersed Installation Using the Lifting Ring

NOTE The LT-63X series sensor should be installed with a minimum distance of >15cm from the bottom of water vessel to the lens of the sensor and a minimum of >10cm from the vessel wall on all sides.

Reference ID	Name
1	Retention Chain / Cable
2	Sensor Output Cable
3	LT-63X Series Turbidity Sensor

4 Calibration and Diagnosis

The LT-63X series sensor is rigorously calibrated before leaving the factory. As such, users do not need to calibrate the sensor for a period of one year if the sensor is maintained clean. Users can however calibrate the sensor according to their needs and as desired using the MA-CR Bluetooth adapter and uPyxis APP for mobile or desktop devices. Likewise, the LT-63X series may also be calibrated after cleaning via PLC or controller through 4-20mA communication.



4.1 Calibration and Diagnosis by uPyxis Mobile APP

Connect and power the LT-63X series sensor to a display, controller or PLC. Insert the Pyxis MA-CR Bluetooth adapter (P/N: MA-CR) as shown in the following connection diagram, using the 8-pin adapters on the provided sensor cables. (Figure). The power should be sourced from a 24 VDC power terminal of the connected display, controller or PLC. If a controller is not available, the LT-63X may also be powered via any 22-26 VDC power supply capable of 6W, that can directly connect to the LT-63X series sensor with provided connection cables from Pyxis. ***NOTE*** The MA-CR provides a micro-display for local visibility of the sensor reading and mA value output.



Figure 5 - LT-63X Series Sensor and MA-CR Bluetooth Adapter Powered By Connected Display, Controller or PLC

Download and install the uPyxis APP from Apple Store or Google Play per the QR codes provided in the image above. Be sure to turn on Bluetooth in the mobile device (please do not pair the device Bluetooth to any Pyxis device, the uPyxis APP will do the pairing). Open the uPyxis APP in the mobile device. Finger swipe the screen downward to refresh the screen and scan for the available Pyxis Bluetooth devices. The discovered devices will be listed (see Figure 6).

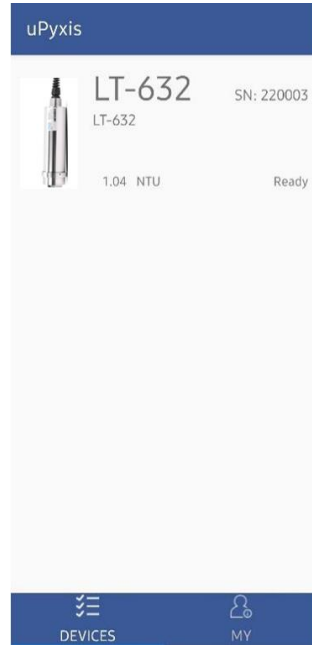

Figure 6

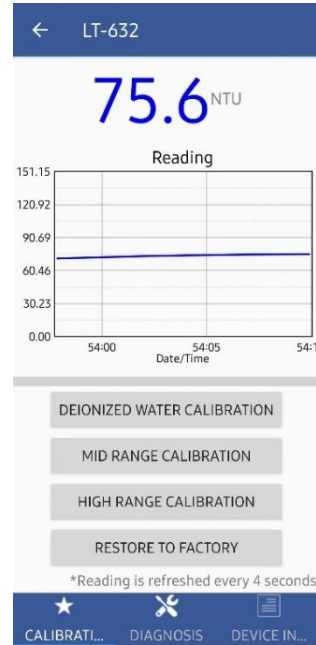

Figure 7

Tap the discovered LT-63X series sensor to connect to it via Bluetooth. The uPyxis APP can identify the sensor type if multiple Pyxis sensors are discovered in the scan.

4.1.1 Calibration

As shown in Figure7, When connected, the **uPyxis®** Mobile App will default to the **Calibration** screen. Four functional tabs are available in this page: Deionized Water Calibration, Mid-Range Calibration, High-Range Calibration and Restore to Factory. The sensor can be calibration with Pyxis Formazin calibration standards or field water samples. Please refer to the following table for the recommended turbidity standard solution for each range:

Calibration Range	LT-631	LT-632	LT-633*
Near Zero/Low	Bubble-free DI or sample < 1NTU		
Mid-low	20–120 NTU	20–120 NTU	50-200 NTU
Mid			450-550 NTU
Mid-High			800-1200 NTU
High	200-500 NTU	200–1000 NTU	1500-4000 NTU

Note (1) The uPyxis® program provides 5-point calibration for the **LT-633** sensor.

(2) The LT-63X series sensor should be calibrated with a minimum distance of >15cm from the bottom of water container to the lens of the sensor and a minimum of >10cm from the vessel wall on all sides(as shown in Figure4).

4.1.1.1 Deionized Water Calibration

1. Remove the LT-63X series sensor and rinse it thoroughly with deionized water. Repeat this rinse process three times. Wipe the sensor with a dust-free cloth or paper-towel to confirm that the sensor is free of obvious impurities.
2. Insert the sensor into a oversized beaker or bucket ([as shown in Figure 4](#)). Add bubble-free deionized water or water with <1.0NTU of turbidity container and wait for the sensor reading to stabilize.
3. Click the "Deionized Water Calibration" button after the reading stabilizes.
4. If the calibration is successful, the interface will return a message "Calibration Succeeded" as shown in Figure 9. If the calibration has failed, the interface will return a message "Calibration Failed", as shown in Figure 10 and the user must repeat the process until calibration success is achieved.

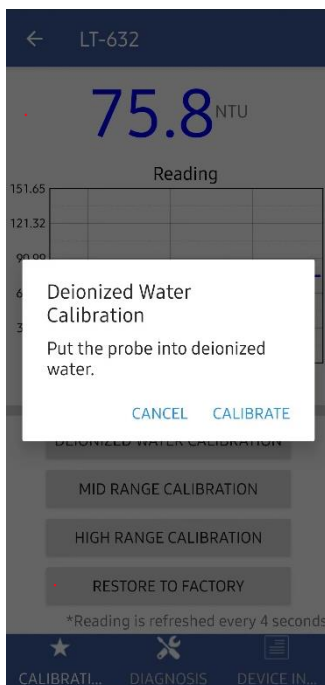

Figure 8

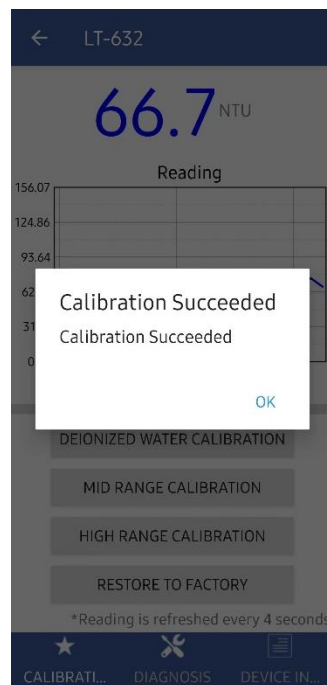

Figure 9

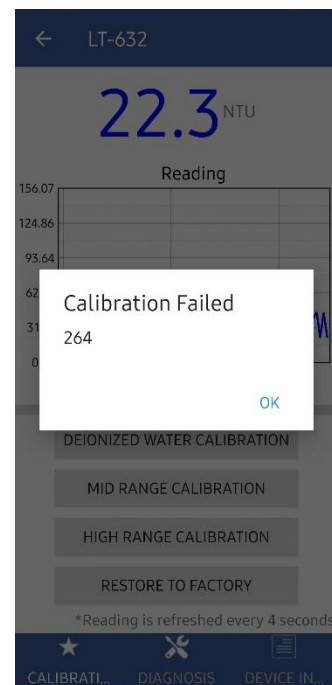

Figure 10

4.1.1.2 Mid-Range Calibration

1. Conduct the Deionized Water Calibration steps above.
2. Remove and insert the LT-63X series sensor into a clean and dry oversized beaker or bucket ([as shown in Figure 4](#)) and add the midpoint calibration solution (Please refer to the table in the previous section for the midpoint turbidity calibration range).
3. Wait until the reading stabilizes and then click the Midpoint Calibration button to calibrate the midpoint to the value of the standard utilized, as shown in Figure 11.
4. If the calibration is successful, the interface will return a message "Calibration Succeeded". If the calibration has failed, the interface will return a message "Calibration Failed" and the user must repeat the process until calibration success is achieved.

4.1.1.3 High-Range Calibration

If the high range calibration is not required, the user does not need to calibrate the high range. To continue with the high range calibration , use the following step:

1. Conduct the Mid-Range Calibration steps above.
2. Remove and insert the LT-63X series sensor into a clean and dry beaker and inject the High Point calibration solution(Please refer to the table in the previous section for the highpoint turbidity calibration range).
3. Wait until the reading stabilizes and then click the High Point Calibration button to calibrate the highpoint to the value of the standard utilized, as in Figure 12.
4. If the calibration is successful, the interface will return a message "Calibration Succeeded". If the calibration has failed, the interface will return a message "Calibration Failed" and the user must repeat the process until calibration success is achieved.

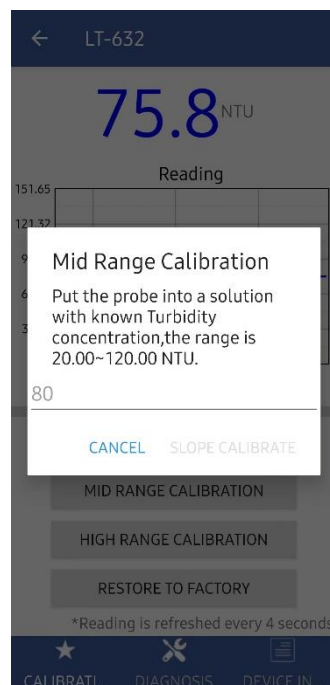

Figure 11

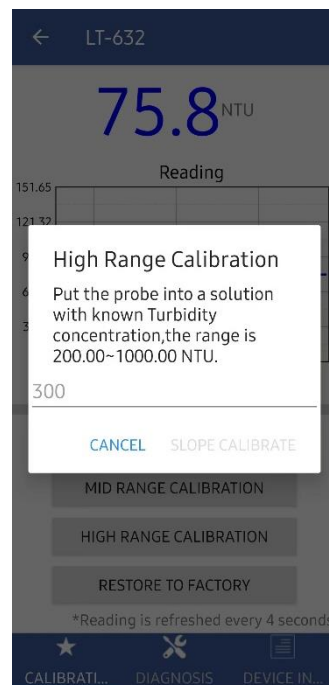

Figure 12

Trouble Shooting Steps for Failed Calibration Messages

- The Deionized water has not been contaminated.
- The standard solution is accurately pre-measured to verify turbidity.
- The sensor is clean and not contaminated with debris or other materials.

4.1.2 Restore to Factory Calibration Settings

Restore To Factory Calibration Settings – If user wants to restore the sensor calibration to factory default parameters, as shown in Figure13, click the OK option to confirm. If the restoration is successful, the interface will return a message "Restore Succeed" (Figure 14).

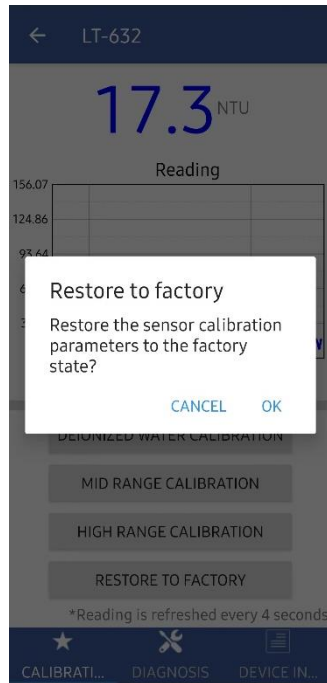

Figure13

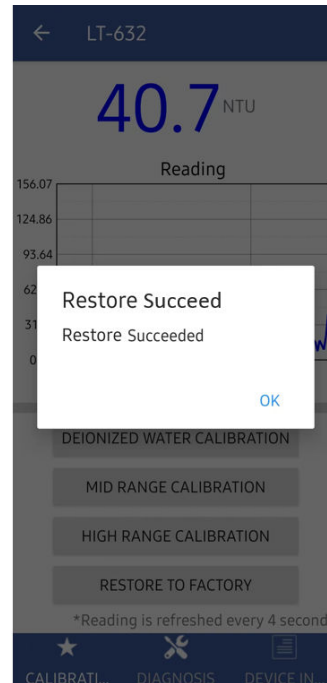

Figure14

4.1.3 Diagnosis

Tap Diagnosis in the bottom of the APP page to launch the diagnosis page (Figure 15).

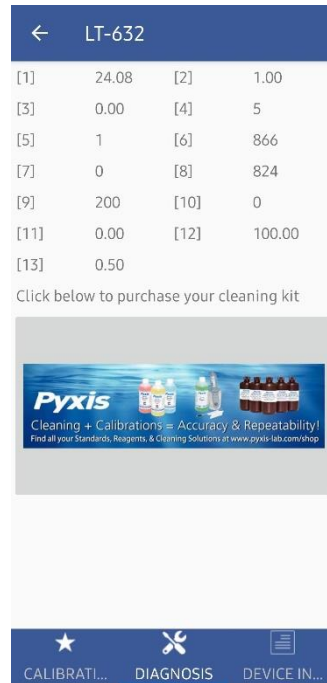

Figure 15 - Select Diagnosis for Sensor

Export/Upload Sensor Diagnosis Data - In this page, the raw data measured by the sensor is displayed. To help troubleshooting possible issues with the sensor, please save images of these data when the sensor is respectively placed in a clean water (tap water or deionized water), in a known Formazin Turbidity Calibration Standard Solution and/or in the sample that the sensor is intended for. This data may be exported from the uPyxis APP via email to service@pyxis-lab.com for technical support.

4.1.4 Cleaning Period Adjustment

Tap Device info in the bottom of the uPyxis APP page to launch the Device info page (Figure 16). You can set the **Device Name**, **Product Name**, **Modbus Address** and **Brush Setting** for the LT-63X series sensor. Press **Brush Once** to activate the wiper arm manually. Be sure to press **Apply Settings** to save any changes.

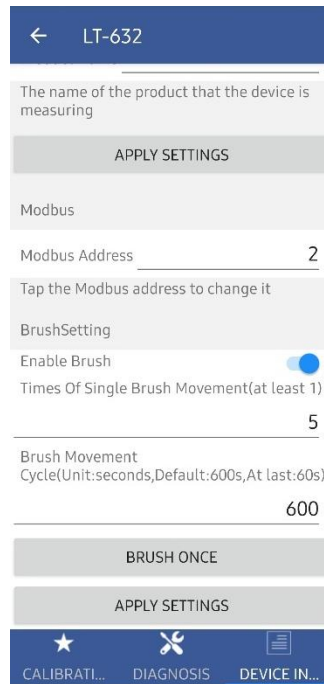
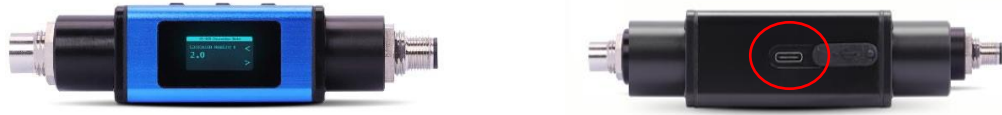

Figure 16 - Cleaning Period Adjustment

4.2 Calibration and Diagnosis by uPyxis Desktop APP

- 1) Download and install uPyxis Desktop APP from <https://upyxis.pyxis-lab.com.cn/release/pc/uPyxis.Setup-latest.zip>
- 2) Connect a USB Type-C cable to the port at the bottom of the MA-CR and to the USB port of the laptop or computer. This will provide power to the MA-CR from the laptop/computer. Connect the MA-CR to the LT-63x series sensor. The MA-CR Bluetooth adapter will boost the 5V of the regular USB to 24V to power the sensor for use with uPyxis Desktop.



MA-CR Bluetooth Adapter – Bottom USB-C

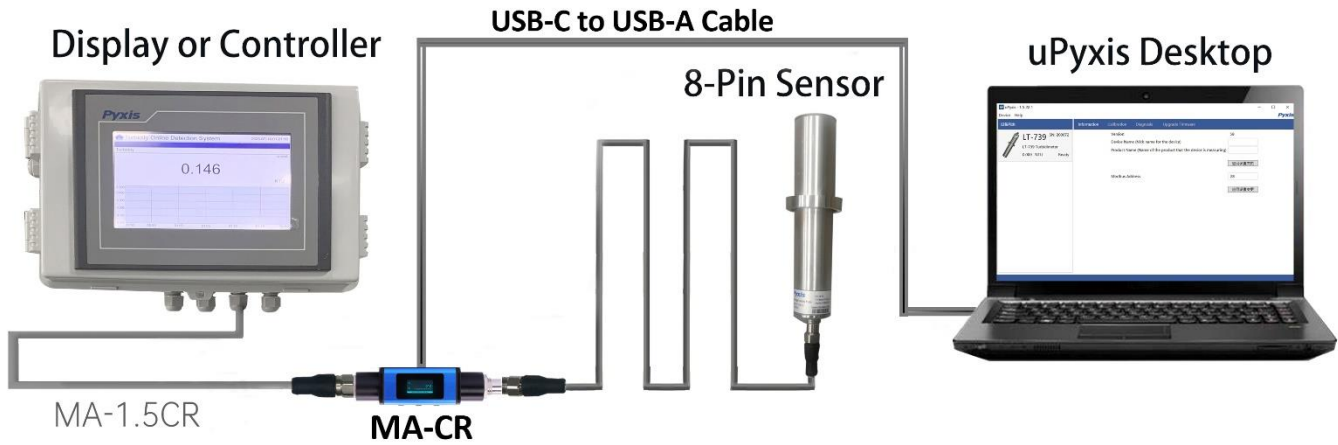

Figure 12 – MA-CR Connected to Sensor & Laptop

- 3) Set the MA-CR to operate in USB Mode by following the steps below.
 - a. Once the MA-CR screen is powered Press ◀ or ▶ until you arrive at (USB to RS485) screen.
 - b. Press the **OK** Button.
 - c. Follow Prompts below to Enable USB feature. Once enabled, you may connect to uPyxis.



- 4) Open the desktop uPyxis APP.
- 5) Click Device to launch the connection option menu.
- 6) Select Connect via USB-RS485 (*Figure 18*).
- 7) Select the Comm Port to make a connection. Normally only one Comm port is identified by uPyxis (*Figure 19*). If more than one Comm port listed in the selection dropdown, you may try to select each one to see if a connection can be made. Alternatively, you may use the Windows Device Manager to identify the Comm Port that the Pyxis USB adapter is using.

After the connection is established, the LT-63X Series sensor series number and current turbidity concentration reading of the water will be displayed on the left of the information page (*Figure 20*). In this page, you can set the **Device Name**, **Product Name**, **Modbus Address** and **Brush Setting** for the device.

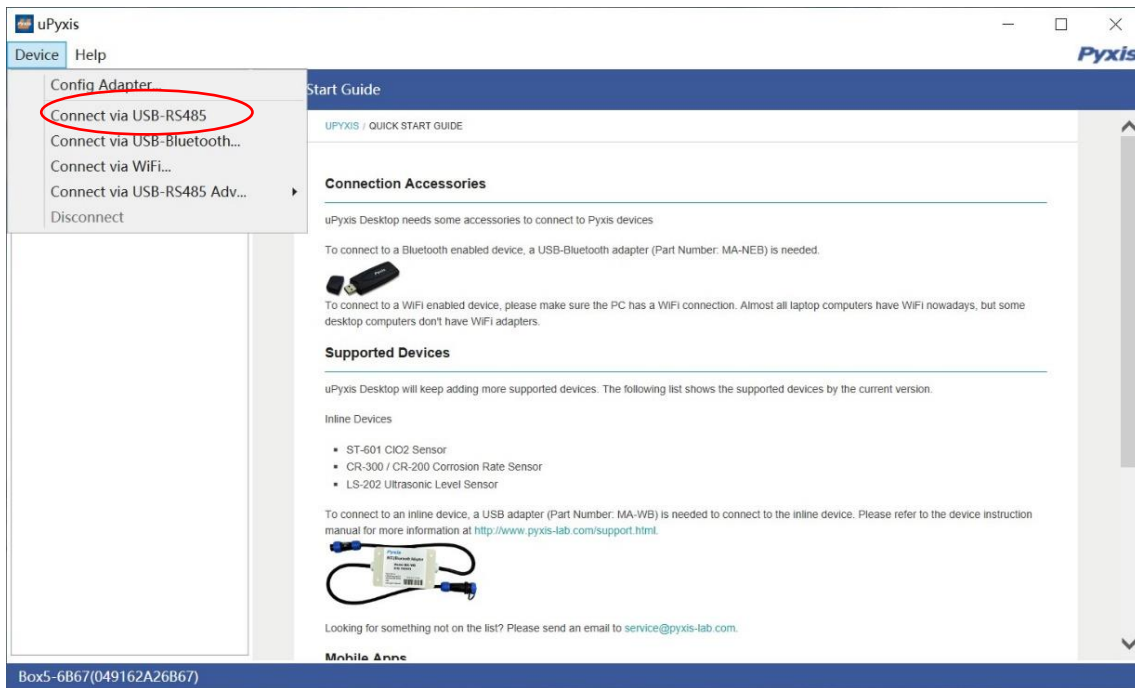

Figure 18 - Connection Options

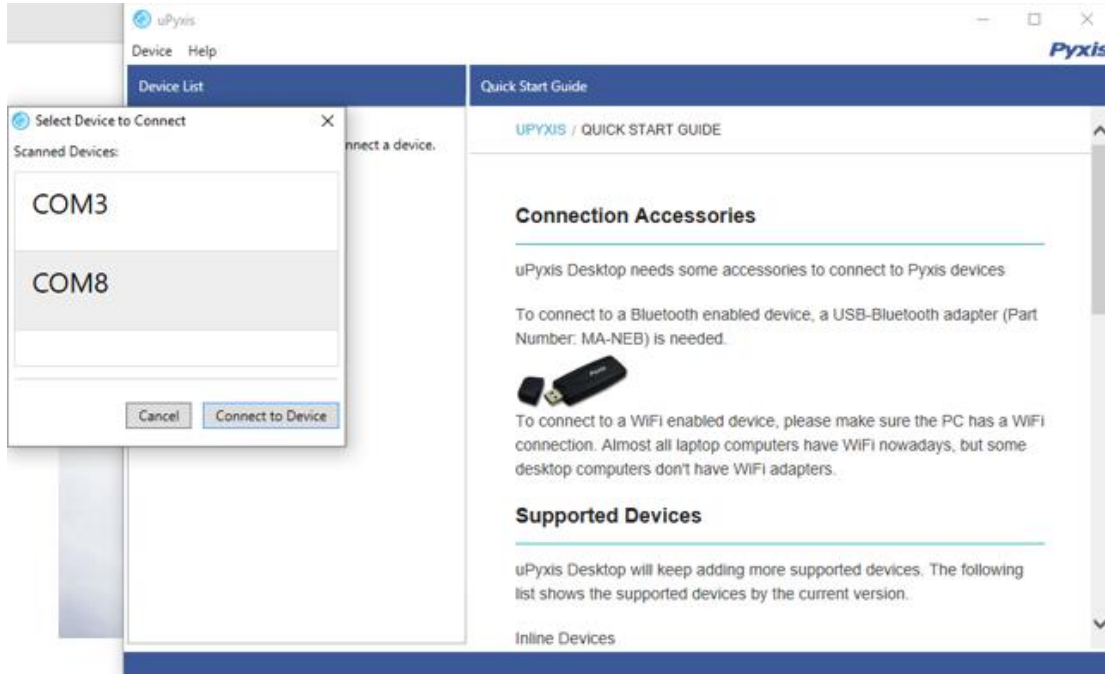

Figure 19 - Select a Comm Port

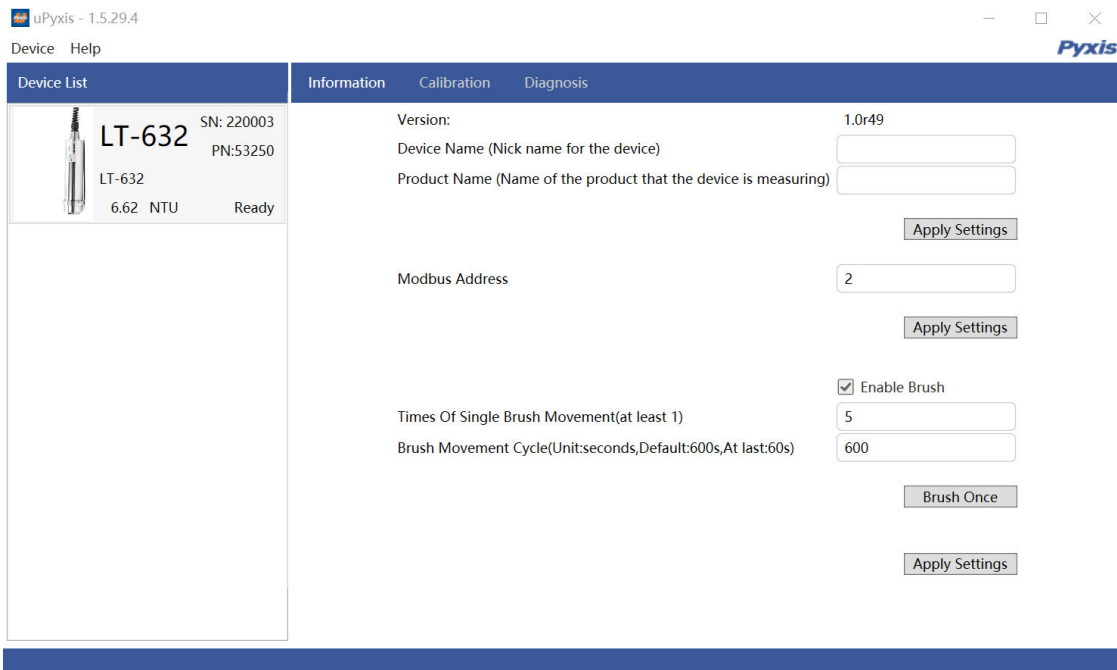

Figure 20 - Connected to a LT-63X series sensor and information page

4.2.1 Calibration

To calibrate the sensor, click on **Calibration**. On the Calibration screen, there are three calibration buttons, **Deionized Water Calibration**, **Mid-Range Calibration**, **High-Range Calibration**. The screen also displays the reading of the device. The reading refresh rate is every 4 seconds.

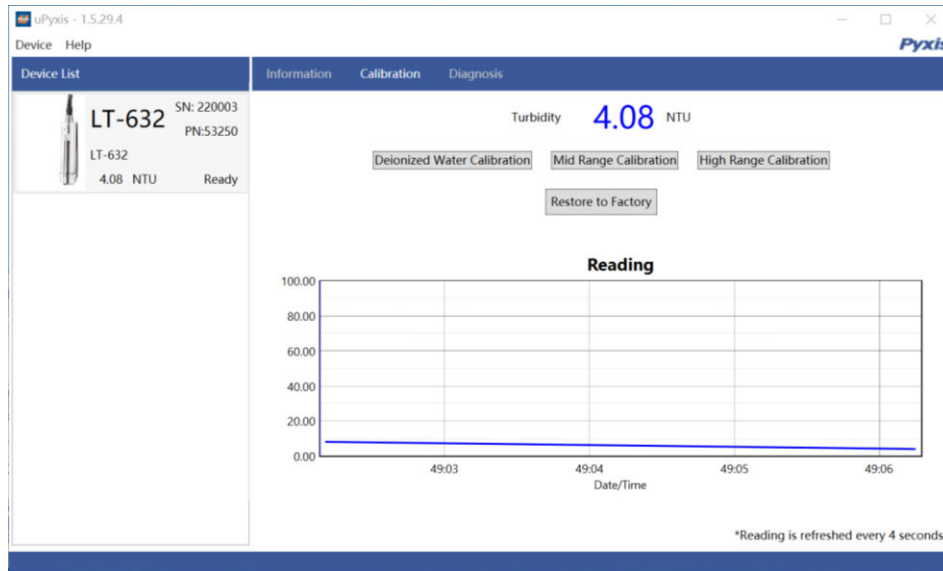

Figure 21 - Calibration Page

The calibration solution can be process water of the application itself or users may also use Pyxis Formazin calibration standard solution. Please refer to the following table for the recommended turbidity standard solution for each range:

Calibration Range	LT-631	LT-632	LT-633*
Near Zero/Low	Bubble-free DI or sample < 1NTU		
Mid-low	20–120 NTU	20–120 NTU	50-200 NTU
Mid			450-550 NTU
Mid-High			800-1200 NTU
High	200-500 NTU	200–1000 NTU	1500-4000 NTU

NOTE : (1) The uPyxis program provides 5-point calibration for the **LT-633** sensor.

(2) The LT-63X series sensor should be calibrated with a minimum distance of >15cm from the bottom of water container to the lens of the sensor and a minimum of >10cm from the vessel wall on all sides([as shown in Figure4](#)).

4.2.1.1 Deionized Water Calibration

1. Remove the LT-63X series sensor and rinse it thoroughly with deionized water. Repeat this rinse process three times. Wipe the sensor with a dust-free cloth or paper-towel to confirm that the sensor is free of obvious impurities.
2. Insert the sensor into a oversized beaker or bucket ([as shown in Figure 4](#)). Add bubble-free deionized water or water with <1.0NTU of turbidity container and wait for the sensor reading to stabilize.
3. Click the “Deionized Water Calibration” button after the reading stabilizes.
4. If the calibration is successful, the interface will return a message "Calibration Succeeded". If the calibration has failed, the interface will return a message "Calibration Failed" and the user must repeat the process until calibration success is achieved.



Figure 22 - Deionized Water Calibration

4.2.1.2 Mid-Range Calibration

1. Conduct the Deionized Water Calibration steps above.
2. Remove and insert the LT-63X series sensor into a clean and dry oversized beaker or bucket ([as shown in Figure 4](#)) and add the midpoint calibration solution (Please refer to the table in the previous section for the midpoint turbidity calibration range).
3. Wait until the reading stabilizes and then click the Midpoint Calibration button to calibrate the midpoint to the value of the standard utilized, as shown in Figure 23.
4. If the calibration is successful, the interface will return a message "Calibration Succeeded". If the calibration has failed, the interface will return a message "Calibration Failed" and the user must repeat the process until calibration success is achieved.

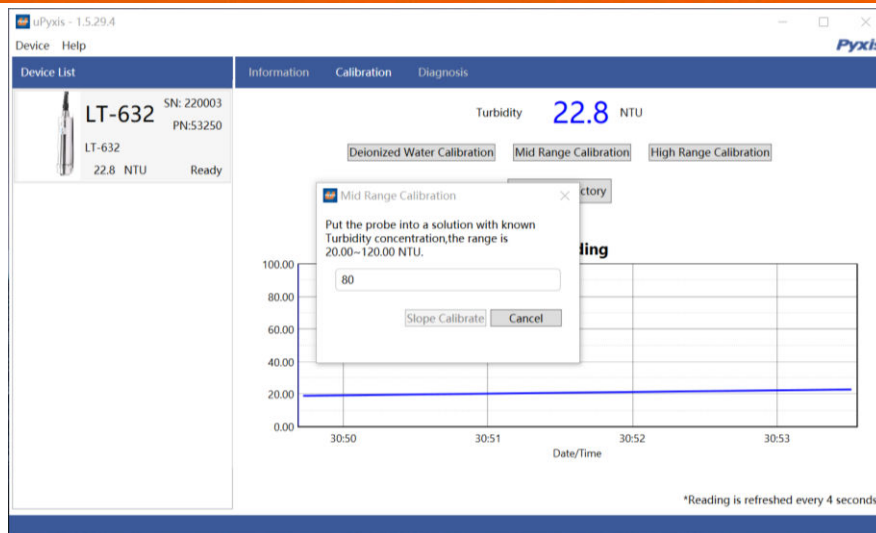

Figure 23 - Mid-Range Calibration

4.2.1.3 High-Range Calibration

If the high range calibration is not required, the user does not need to calibrate the high range. To continue with the high range calibration, use the following step:

1. Conduct the Mid-Range Calibration steps above.
2. Remove and insert the LT-63X series sensor into a clean and dry beaker (as shown in Figure 4) and inject the High Point calibration solution (Please refer to the table in the previous section for the highpoint turbidity calibration range).
3. Wait until the reading stabilizes and then click the High Point Calibration button to calibrate the highpoint to the value of the standard utilized, as in Figure 24.
4. If the calibration is successful, the interface will return a message "Calibration Succeeded". If the calibration has failed, the interface will return a message "Calibration Failed" and the user must repeat the process until calibration success is achieved.

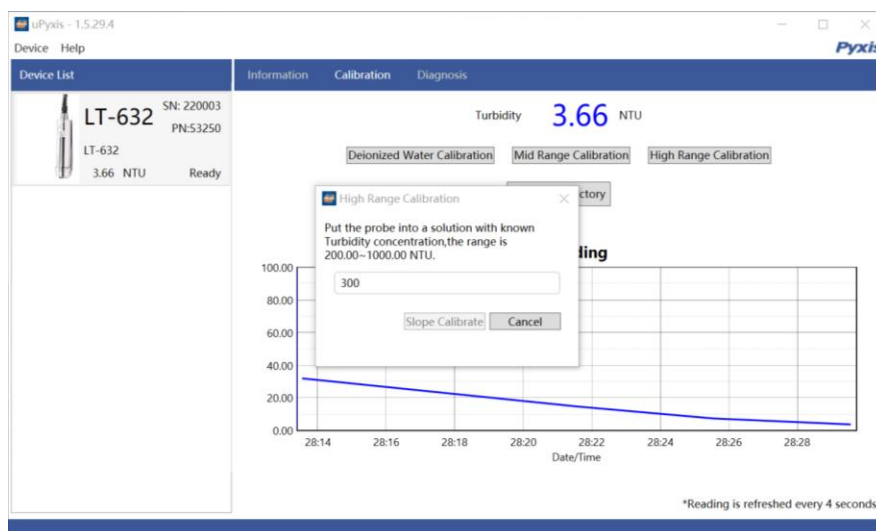

Figure 24 - High-Range Calibration

Trouble Shooting Steps for Failed Calibration Messages

- The Deionized water has not been contaminated.
- The standard solution is accurately pre-measured to verify turbidity.
- The sensor is clean and not contaminated with debris or other materials.

4.2.2 Restore to Factory

Restore To Factory Calibration Settings – If user wants to restore the sensor calibration to factory default parameters, click the OK option to confirm. If the restoration is successful, the interface will return a message "Restore Succeed" (Figure 25).

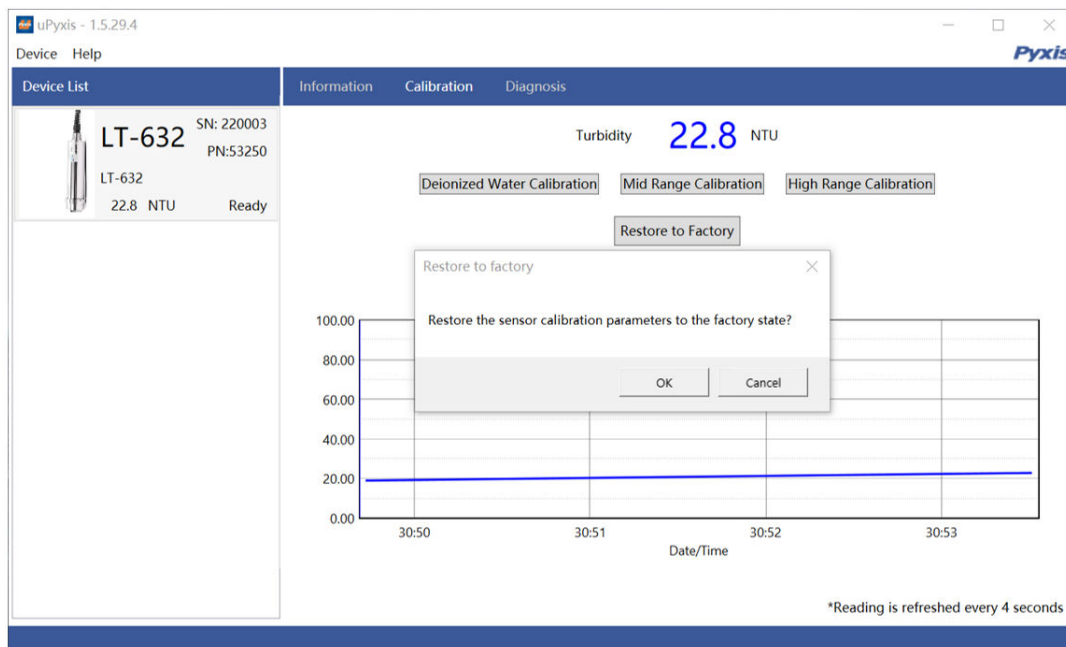

Figure 25 - Restore to Factory

4.2.3 Diagnosis

Export/Upload Sensor Diagnosis Data - In this page, the raw data measured by the sensor is displayed. To help troubleshooting possible issues with the sensor, please save images of these data when the sensor is respectively placed in a clean water (tap water or deionized water), in a known Formazin Turbidity Calibration Standard Solution and/or in the sample that the sensor is intended for. This data may be exported from the uPyxis APP via email to service@pyxis-lab.com for technical support.

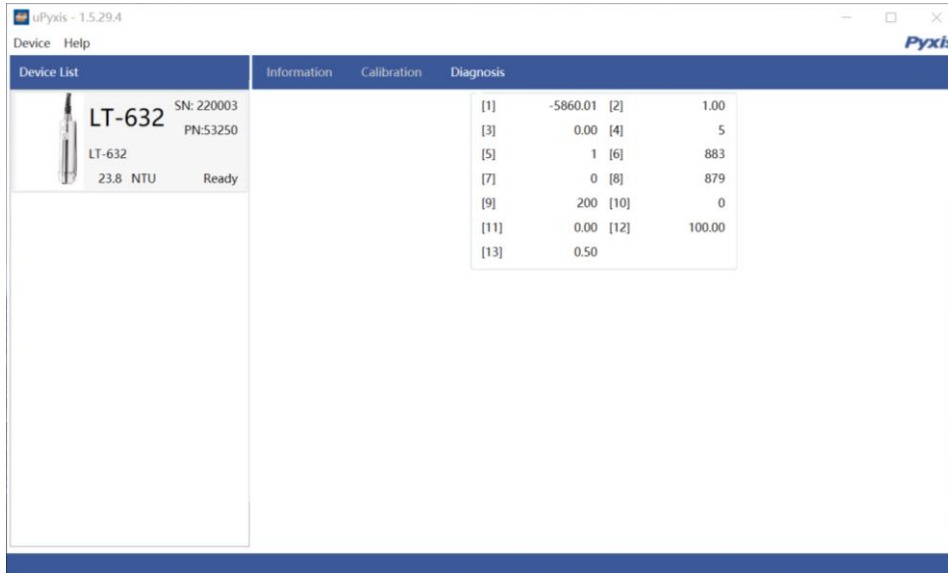

Figure 26 - Select Diagnosis Condition

4.2.4 Cleaning Period Adjustment

In information page, you can set the **Device Name**, **Product Name**, **Modbus Address** and **Brush Setting** for the LT-63X series sensor. Press **Brush Once** to activate the wiper arm manually. Be sure to press **Apply Settings** to save any changes.

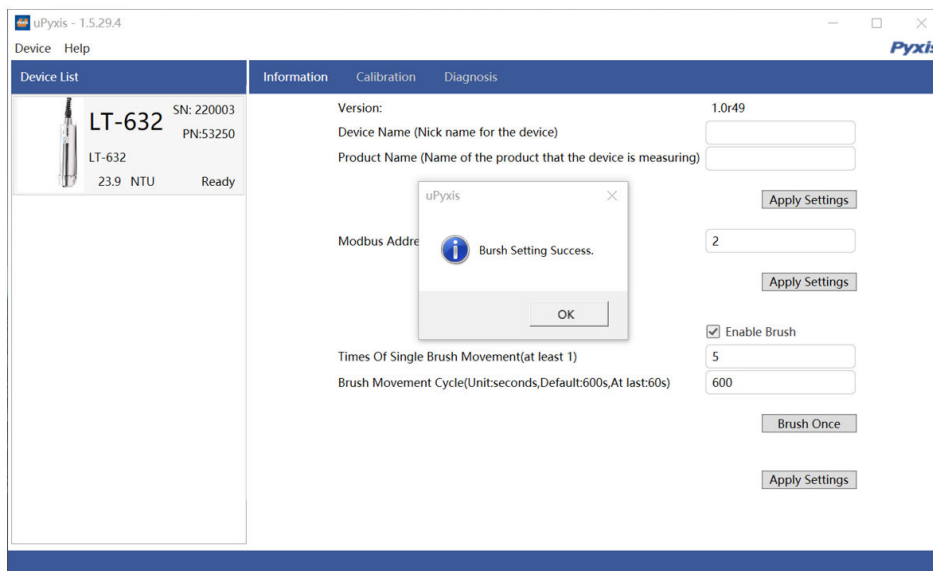

Figure 27 –Cleaning Period Adjustment

5 Modbus RTU

The LT-63X series sensor is configured as a Modbus slave device. In addition to the turbidity value, other operational parameters, including warning and error messages, are available via a Modbus RTU connection. Contact Pyxis Lab Customer Service service@pyxis-lab.com for more information.

6 Sensor Cleaning and Maintenance

The LT-63X series sensor is designed to provide reliable and continuous turbidity readings. Although a self-cleaning feature has been added, heavy fouling can prevent light from reaching the sensor and may affect the accuracy of the sensor, depending on application conditions.

The LT-63X series sensor is designed to be easily removed, inspected and cleaned if required.

Aged heavy deposition, especially inorganic deposits such as iron oxide and calcium carbonate, can be removed by submersing and soaking (15 minutes) the LT-63X series sensor into the Pyxis Sensor Cleaning Solution Kit available from Pyxis online Estore/Catalog <https://www.pyxis-lab.com/product/inline-sensor-cleaning-kit/>



Figure 28 – Pyxis Probe Cleaning Solution Kit (P/N: SER-01)

7 Sensor Wiper Replacement Instructions

Replacement of wiper arm assembly is outlined below.

Step 1 Set the wiper arm assembly to a horizontal position after powering off the sensor.

Step 2 Remove the M2 screw that holds the wiper arm assembly nut.

Step 3 Remove the old wiper arm assembly.

Step 4 Install the wiper arm assembly to the sensor.

Step 5 Install the new M2 screw into the nut.



Figure 29
Set wiper arm to horizontal position



Figure 30
Remove the M2 screw

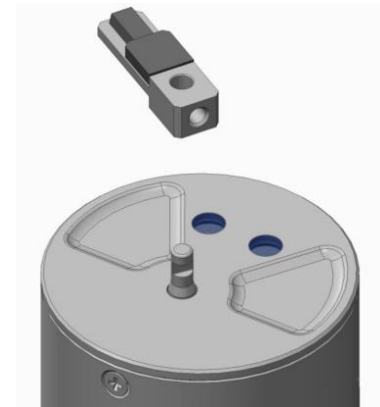

Figure 31
Remove the old wiper arm



Figure 32
Install the new wiper arm



Figure 33
Install the new M2 screw into the new wiper arm nut

8 Contact Us

Contact us if you have questions about the use or maintenance of the LT-63x series sensor:

Pyxis Lab, Inc.

21242 Spell Circle

Tomball, TX. 77375

1-866-203-8397

www.pyxis-lab.com

service@pyxis-lab.com