

Pyxis[®]

ST-601 ClO₂ Concentration Sensor User Manual



Water Professionals Deserve Better Tools.
www.pyxis-lab.com

ST-601 ClO₂ Concentration Sensor User Manual

September 16, 2022
Rev. 2.06

Pyxis Lab, Inc.
21242 Spell Circle
Tomball TX, 77375
www.pyxis-lab.com

Table of Contents

1 Introduction	2
1.1 Main Features.....	2
2 Specifications	3
3 Unpacking Instrument	3
3.1 Standard Accessories.....	3
3.2 Optional Accessories	4
4 Installation	5
4.1 In-line Piping	5
4.2 Teflon Tubing	6
4.3 Wiring	6
4.4 Connecting via Bluetooth	7
4.5 Connecting via USB.....	7
5 Setup and Calibration with uPyxis® MobileApp	8
5.1 Download uPyxis® Mobile App.....	8
5.2 Connecting to uPyxis® Mobile App.....	9
5.3 Calibration Screen and Reading	10
5.3.1 Zero Calibration.....	10
5.3.2 Slope Calibration	10
5.4 Diagnosis Screen.....	12
5.5 Device Info Screen	12
6 Setup and Calibration with uPyxis® Desktop App	13
6.1 Install uPyxis® Desktop App.....	13
6.2 Connecting to uPyxis® Desktop App.....	14
6.3 Information Screen.....	15
6.4 Calibration Screen	15
6.4.1 Zero Calibration.....	16
6.4.2 Slope Calibration	16
6.5 Diagnosis Screen.....	17
7 Outputs	17
7.1 4–20mA Output Setup.....	17
7.2 Adjusting 4–20mA Span.....	18
7.3 Communication using Modbus RTU	18
8 Sensor Maintenance and Precaution	19
8.1 Methods to Cleaning the ST-601.....	19
8.2 Storage	20
9 Troubleshooting	20
10 Contact Us	20
REVISION HISTORY	21

Warranty Information

Confidentiality

The information contained in this manual may be confidential and proprietary and is the property of Pyxis Lab, Inc. Information disclosed herein shall not be used to manufacture, construct, or otherwise reproduce the goods described. Information disclosed herein shall not be disclosed to others or made public in any manner without the express written consent of Pyxis Lab, Inc.

Standard Limited Warranty

Pyxis Lab warrants its products for defects in materials and workmanship. Pyxis Lab will, at its option, repair or replace instrument components that prove to be defective with new or remanufactured components (i.e., equivalent to new). The warranty set forth is exclusive and no other warranty, whether written or oral, is expressed or implied.

Warranty Term

The Pyxis warranty term is thirteen (13) months ex-works. In no event shall the standard limited warranty coverage extend beyond thirteen (13) months from original shipment date.

Warranty Service

Damaged or dysfunctional instruments may be returned to Pyxis for repair or replacement. In some instances, replacement instruments may be available for short duration loan or lease.

Pyxis warrants that any labor services provided shall conform to the reasonable standards of technical competency and performance effective at the time of delivery. All service interventions are to be reviewed and authorized as correct and complete at the completion of the service by a customer representative, or designate. Pyxis warrants these services for 30 days after the authorization and will correct any qualifying deficiency in labor provided that the labor service deficiency is exactly related to the originating event. No other remedy, other than the provision of labor services, may be applicable.

Repair components (parts and materials), but not consumables, provided during a repair, or purchased individually, are warranted for 90 days ex-works for materials and workmanship. In no event will the incorporation of a warranted repair component into an instrument extend the whole instrument's warranty beyond its original term.

Warranty Shipping

A Repair Authorization (RA) Number must be obtained from Pyxis Technical Support before any product can be returned to the factory. Pyxis will pay freight charges to ship replacement or repaired products to the customer. The customer shall pay freight charges for returning products to Pyxis. Any product returned to the factory without an RA number will be returned to the customer. To receive an RMA you can generate a request on our website at <https://pyxis-lab.com/request-tech-support/>.

Pyxis Technical Support

Contact Pyxis Technical Support at +1 (866) 203-8397, service@pyxis-lab.com, or by filling out a request for support at <https://pyxis-lab.com/request-tech-support/>.

1 Introduction

The Pyxis ST-601 inline sensor is uniquely designed to measure the real-time mass/mass concentration of chlorine dioxide (ClO₂). The ST-601 sensor measures the optical absorbance of the ClO₂ solution using a UV light source. The sensor has a built-in reference light source and a reference light detector in addition to the main light source and main light detector.

The ST-601 offers an expanded range and a RTD temperature output signal. This features allow the user to measure ClO₂ as high as 0.35% (mass/mass) and obtain a temperature measurement, useful when required to consider the impact of atmospheric temperature conditions on variable ClO₂ concentration readings.

The ST-601 can be connected to any device that accepts an isolated or non-isolated 4–20mA input or RS-485 Modbus. As with all Pyxis inline sensors, the ST-601 sensor can be wirelessly accessed via Bluetooth when used in conjunction with the MA-WB Bluetooth Adapter or PowerPACK Series Auxiliary Box and the **uPyxis**® App for mobile and desktop devices. Directions on this wireless calibration capability are included in this manual.

Primary Installation Format

The primary method is to install the probe in-line with the suction side of the chemical feed pump in piping format. This method should ideally run in a vertical line to avoid chlorine gas bubble interference. This can be done with the standard ST-001 Inline Tee Assembly (3/4" FNPT) provided with each sensor. Pyxis also offers 2" and 3" inline tee assemblies as an accessory option if required.

Teflon Tube Installation Format

The second method is to install the probe in-line using the unique 1/4" OD (7 mm OD) clear Teflon tubing adapter 6 inches in length. This tubing can be passed "THROUGH" the optical channel allowing to use the sensor with smaller chemical feed line installations on the suction side of the chemical feed pump.

NOTE For enhanced ambient light interference prevention, Pyxis recommends users to apply black electrical tape or shrink wrap to allow sample darkening prior to and after the optical channel as seen in Figure 3.

1.1 Main Features

The ST-601 sensor includes the following features:

- Can be conveniently connected to the suction or discharge side of the bleach pump in both inline Tee (ST-001) or 1/4" Teflon tubing format with using a union; both included with sensor.
- Can be wirelessly calibrated using a known chlorine dioxide concentration standard with the **uPyxis**® Mobile or Desktop App via a MA-WB Bluetooth/WiFi adapter or PowerPACK Series Auxiliary Box.
- Diagnostic information (sensor tubing fouling and failure modes) can be communicated to digital displays via Modbus RTU.
- Offers an expanded range and a temperature signal communicated via 2-channel 4–20mA outputs and a RS-485 output, Modbus RTU.
- Easy to remove from the system for cleaning and calibration without the need for any tools.

2 Specifications

Table 1. ST-601 Specifications

Specification*	ST-601
Part Number (P/N)	50232
Chlorine Dioxide Concentration Range	0–0.35% mass/mass (RTD Compensated)
Chlorine Dioxide Concentration Resolution	0.01%
Chlorine Dioxide Concentration Accuracy	2% of reading or 0.1%
Temperature Output Range	4 mA: 32 °F (0 °C), 20 mA: 212 °F (100 °C)
Method	UV Absorbance
Calibration	Two-point calibration against known ClO ₂ concentration solution
Outputs	2x 4–20mA Analog Output, RS-485 Digital Output with Modbus protocol
Installation	1/4" OD (7 mm) Teflon tubing for measurement flow and custom tee assembly (P/N: ST-001) with 3/4" female socket & NPT threaded ports
Cable Length	5 ft with IP67 connectors & 2 ft flying lead with IP67 adapter
Power Supply	22–26 VDC, 2W
Dimension (L × Dia)	6.8 × 1.44 inch (172.7 × 36.6 mm)
Weight	0.37 lbs (170 g)
Material	CPVC
Operational Temperature	40–120 °F (4–50 °C)
Storage Temperature	20–140 °F (-7–60 °C)
Pressure	Up to 100 psi (0.7 MPa)
Enclosure Rating	IP67
Regulation	CE/RoHS

* With Pyxis's continuous improvement policy, these specifications are subject to change without notice.

3 Unpacking Instrument

Remove the instrument and accessories from the shipping container and inspect each item for any damage that may have occurred during shipping. Verify that all accessory items are included. If any item is missing or damaged, please contact Pyxis Lab Customer Service at service@pyxis-lab.com.

3.1 Standard Accessories

- Tee Assembly 3/4" NPT (1x Tee, O-ring, and Nut) P/N: ST-001
- 7-Pin Female Adapter/Flying Leads Cable (2 ft) P/N: MA-1100
- Clear Teflon Tubing 1/4" OD (6") Adapter
- User Manual available online at <https://pyxis-lab.com/support/>

3.2 Optional Accessories

The following optional accessories can be ordered at order@pyxis-lab.com or the Pyxis E-Store at <https://pyxis-lab.com/shop/>











 PYXIS INLINE SENSOR ACCESSORIES - SELECT*A*GUIDE 		
Accessory Name/Description	Part Number	Photo
Pyxis ST Series Cleaning Kit <i>(Includes 500mL Sensor Cleaner / Qtips & Pipe Cleaners)</i>	SER-01	
0.75" NPT Inline Sensor Tee Assembly <i>(All ST Series Sensors)</i>	50704	
2.0" NPT Inline Sensor Tee Assembly <i>(All ST Series Sensors)</i>	50756	
3.0" NPT Inline Sensor Tee Assembly <i>(All ST Series Sensors)</i>	50775	
ST-002 Inline Sensor Removal PLUG <i>(Allows ST Sensor Removal)</i>	ST-002	
ST Sensor Tee Replacement O-Ring <i>(All ST Series Tee's)</i>	MA-150	
MA-WB Bluetooth Adapter for All ST Series Sensors <i>(4-20mA & RS-485)</i>	MA-WB	
MA-485 USB Adapter for All ST Series Sensors <i>(4-20mA RS-485)</i>	MA-485	
Bluetooth PC to Handheld Adapter <i>(For uPyxis Firmware Updates)</i>	MA-NEB	
PowerPack 1 <i>(Single Channel Power Supply w/Bluetooth)</i>	MA-BLE-1	
PowerPack 4 <i>(Four Channel Power Supply w/Bluetooth)</i>	MA-BLE-4	
MA-1100 <i>(24' Flying Lead Cable for All ST Sensors)</i>	MA-1100	
MA-C10 <i>(10' Extension Cable for All ST Sensors)</i>	50738	
MA-C50 <i>(50' Extension Cable for All ST Sensors)</i>	50705	

Figure 1.

4 Installation

4.1 In-line Piping

The primary method is to install the ST-601 series inline probes in-line connected to the suction or discharge side of the chemical feed pump in piping format. This method should ideally run in a vertical line to avoid chlorine dioxide gas bubble interference. This can be done with the standard ST-001 Inline Tee Assembly (3/4" FNPT) provided with each sensor. Pyxis also offers 2", 3" and 4" inline tee assemblies as an accessory option if required.

1. Insert the provided O-ring into the O-ring groove on the tee.
2. Insert the ST-601 sensor into the tee.
3. Tighten the tee nut onto the tee to form a water-tight, compression seal.

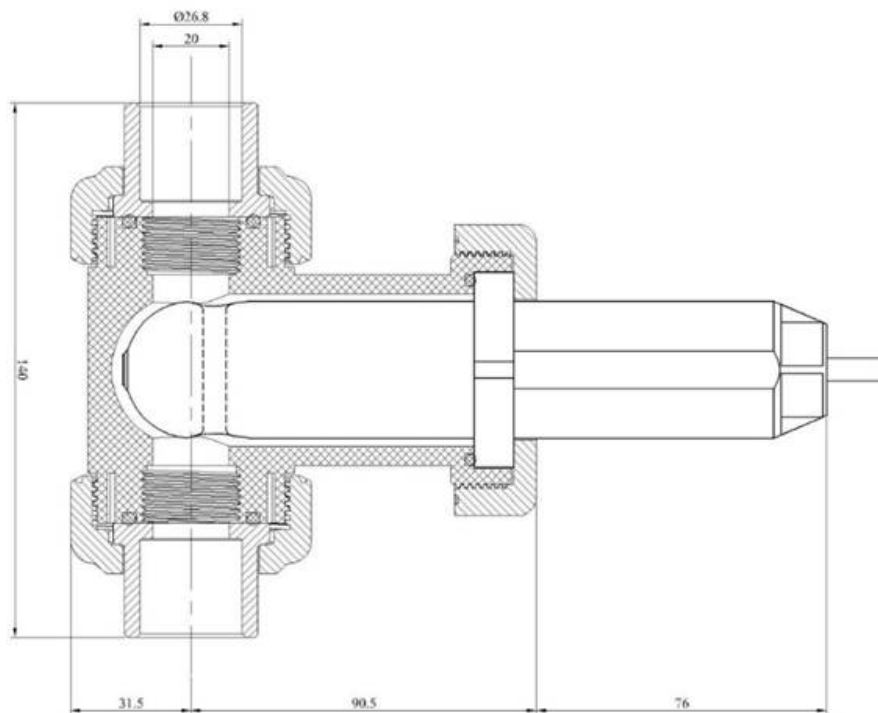

Figure 2. Dimension of the ST-601 sensor and the ST-001 Tee Assembly (mm)

4.2 Teflon Tubing

To install the ST-601 series probes inline using the unique ¼" OD (7mm OD) clear Teflon tubing adapter 6 inches in length. This tubing can be passed "THROUGH" the optical channel allowing to use the sensor with smaller chemical feed line installations on the suction side of the chemical feed pump. Users can use conventional ¼" OD Compression Fittings to connect desired inlet and outlet chemical line size to the ST-601 sensors in this format. As with the inline Pipe installation method, Pyxis recommends installation on a vertical run, ideally on the suction side.

NOTE For enhanced ambient light interference prevention, Pyxis recommends users apply black electrical tape or shrink wrap to allow sample darkening prior to and after the optical channels as seen in Figure 3.



Figure 3. ST-601 sensor with clear Teflon tube adapter

4.3 Wiring

If insufficient wattage is available from the connected controller (ie. 2.0 W), Pyxis recommends the Power-PACK Series Auxiliary Power & Communication Box highlighted in the **Optional Accessories** section.

NOTE There is no 4–20mA negative wire to the controller, please connect controller 24V power ground terminal to controller 4–20mA negative terminal with a short wire.

Follow the wiring table below to connect the ST-601 sensor to a controller. ***IMPORTANT NOTE*** there are two wiring tables for sensors. The Green and White wires (4-20mA values) are different between each table. Listed above each table the specific serial # roll in representing when this change occurred.

ST-601 Wiring Table for Sensors **BEFORE** Serial # - 210011

Wire Color	Designation
Red	24V +
Black	24V Power ground
White	4–20mA + for Temperature
Green	4–20mA + for ClO ₂
Blue	RS-485 A
Yellow	RS-485 B
Clear	Shield, earth ground

ST-601 Wiring Table for Sensors INCLUDING & AFTER Serial # - 210011

Wire Color	Designation
Red	24V +
Black	24V Power ground
White	4–20mA + for CLO2
Green	4–20mA + for Temperature
Blue	RS-485 A
Yellow	RS-485 B
Clear	Shield, earth ground

4.4 Connecting via Bluetooth

A Bluetooth adapter (P/N: MA-WB) can be used to connect a ST-601 sensor to a smart phone with the uPyxis® Mobile App or a computer with the uPyxis® Desktop App.

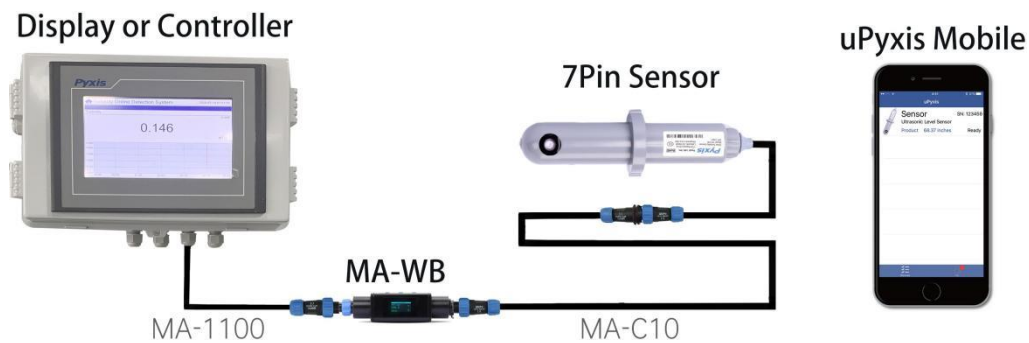

Figure 4. Bluetooth connection to ST-601 sensor with MA-WB and uPyxis Mobile App.

4.5 Connecting via USB

A USB-RS485 adapter (P/N: MA-485) can be used to connect a ST-601 sensor to a computer with the uPyxis® Desktop App.

NOTE Using non-Pyxis USB-RS485 adapters may result in permanent damage of the ST-601 sensor communication hardware.

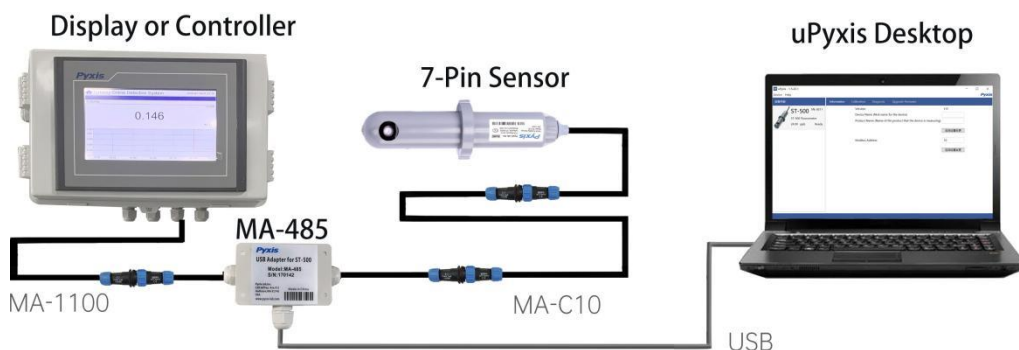

Figure 5. USB connection to ST-601 sensor with MA-WB and uPyxis Mobile App.

5 Setup and Calibration with uPyxis® Mobile App

5.1 Download uPyxis® Mobile App

Download uPyxis® Mobile App from [Apple App Store](#) or [Google Play](#).



Figure 6. uPyxis® Mobile App installation

5.2 Connecting to uPyxis® Mobile App

Connect the ST-601 sensor to a mobile smart phone according to the following steps:

1. Open **uPyxis®** Mobile App.
2. On **uPyxis®** Mobile App, pull down to refresh the list of available Pyxis devices.
3. If the connection is successful, the ST-601 and its Serial Number (SN) will be displayed (Figure 7).
4. Press on the **ST-601 sensor image**.

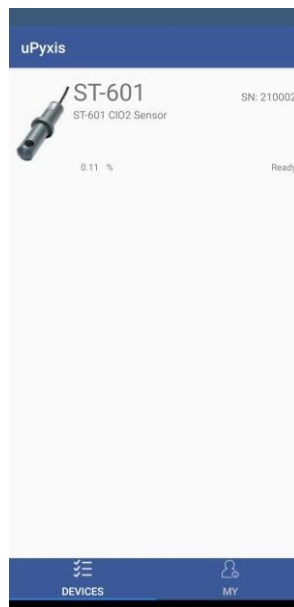

Figure 7.

5.3 Calibration Screen and Reading

When connected, the uPyxis® Mobile App will default to the **Calibration** screen. From the **Calibration** screen, you can perform calibrations by pressing on **Zero Calibration**, **Slope Calibration**, and **4–20mA Span**. Follow the screen instructions for each calibration step.

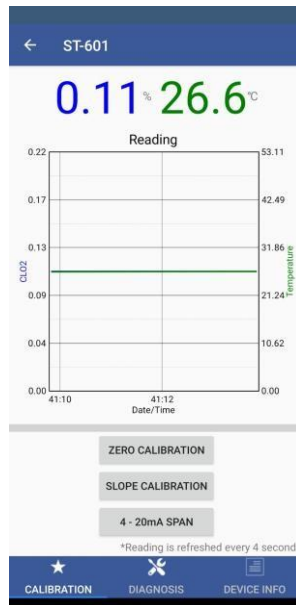

Figure 8.

5.3.1 Zero Calibration

1. Place the ST-601 Series sensor in deionized water.
2. Once the displayed CLO2 and temperature values are stable, click **Zero Calibration** to perform a zero calibration.
3. If the calibration is successful, the interface will return a message "Calibration Succeeded". If the calibration fails, click **Zero Calibration** again and repeat.

5.3.2 Slope Calibration

1. Place the ST-601 Series sensor in a known CLO2 calibration standard
2. Enter the CLO2 concentration in the dialog window as in (figure 9). For the best result, the CLO2 standard concentration should be in the range of 1,000ppm to 3,000ppm for the ST-601 probe.
3. Once the displayed CLO2 and temperature values are stable, click **Slope Calibration** to carry out the slope calibration. The calibration solution could be the sample CLO2 itself (in the chemical tank). The concentration of CLO2 in the sample water can be determined with using a Pyxis SP-910 Handheld meter using CLO2 High Range Direct Read method (0-1,500ppm), or by conventional titration method.
4. If the calibration is successful, the interface will return a message "Calibration Succeeded". If the calibration fails, click **Slope Calibration** again and repeat.

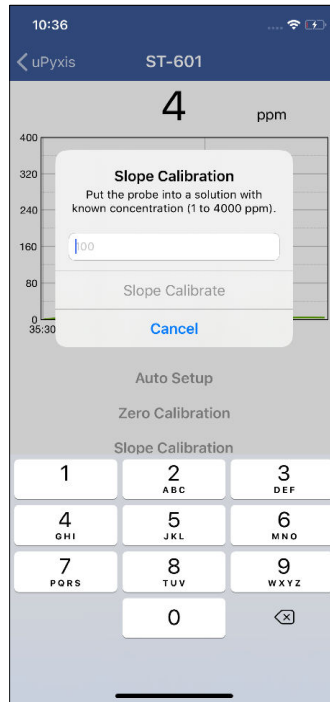

Figure 9.

5.4 Diagnosis Screen

To perform a sensor diagnosis and cleanliness check, first insert the sensor into a beaker of DI water or clean tap water and cover the sensor with a towel to protect from ambient light. Select the **Diagnosis Condition** which defines the fluid type that the ST-601 sensor is currently measuring, then click **Cleanliness Check**. If the sensor is clean, a green **Clean** message will be shown. If the sensor is severely fouled, a red **Dirty** message will be shown. In this case, follow the procedure in the **Methods to Cleaning the ST-601 Sensor** section of this manual. From the **Diagnosis** screen, you view and take a screen shot of the diagnosis condition data values. This feature may be used for technical support when communicating with service@pyxis-lab.com.

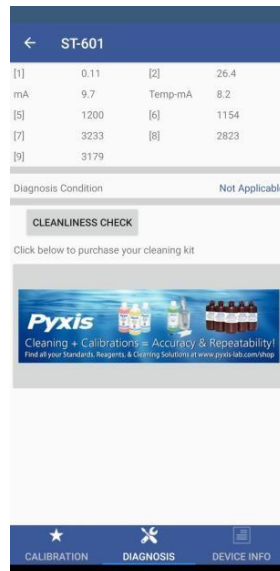

Figure 10.

5.5 Device Info Screen

From the **Device Info** screen. You can name the Device or Product as well as set the Modbus address.

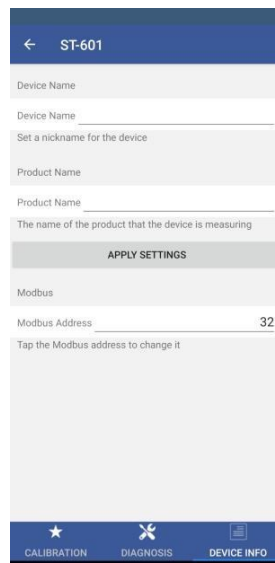

Figure 11.

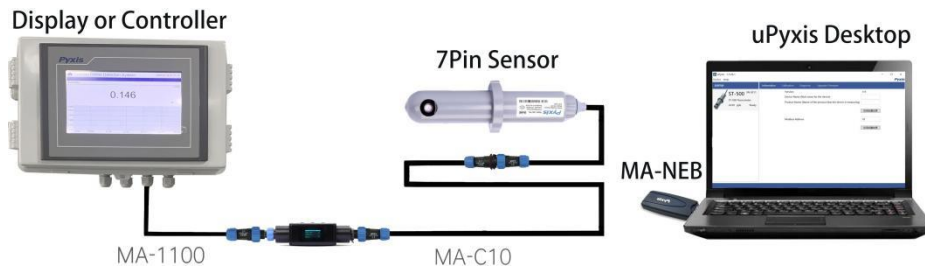

Figure 12. Bluetooth connection to ST-601 sensor with MA-WB and MA-NEB and uPyxis Desktop App.

6 Setup and Calibration with uPyxis® Desktop App

6.1 Install uPyxis® Desktop App

Download the latest version of **uPyxis®** Desktop software package from: <https://pyxis-lab.com/upyxis/> this setup package will download and install the Microsoft.Net Framework 4.5 (if not previously installed on the PC), the USB driver for the USB-Bluetooth adapter (MA-NEB), the USB-RS485 adapter (MA-485), and the main **uPyxis®** Desktop application. Double click the **uPyxis.Setup.exe** file to install.

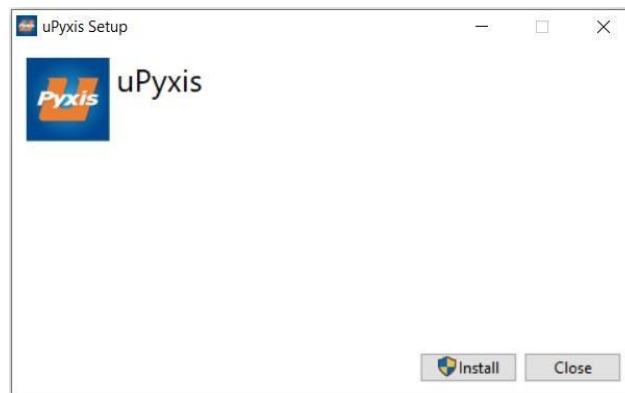

Figure 13. uPyxis® Desktop App installation

Click **Install** to start the installation process. Follow the screen instructions to complete the USB driver and **uPyxis®** installation.

6.2 Connecting to uPyxis® Desktop App

Connect the ST-601 sensor to a Windows computer using either a Bluetooth/USB adapter (P/N: MA-NEB) or a USB-RS485 adapter (P/N: MA-485) according to the following steps:

1. Plug the Bluetooth/USB adapter or USB-RS485 adapter into a USB port in the computer.
2. Launch **uPyxis®** Desktop App.
3. On **uPyxis®** Desktop App, click Device → **Connect via USB-Bluetooth** or **Connect via USB-RS485** (Figure 12).
4. If the connection is successful, the ST-601 sensor and its Serial Number (SN) will be displayed in the left pane of the **uPyxis®** window.

NOTE After the sensor and Bluetooth is powered up, it may take up to 10 seconds for the adapter to establish the wireless signal for communication.

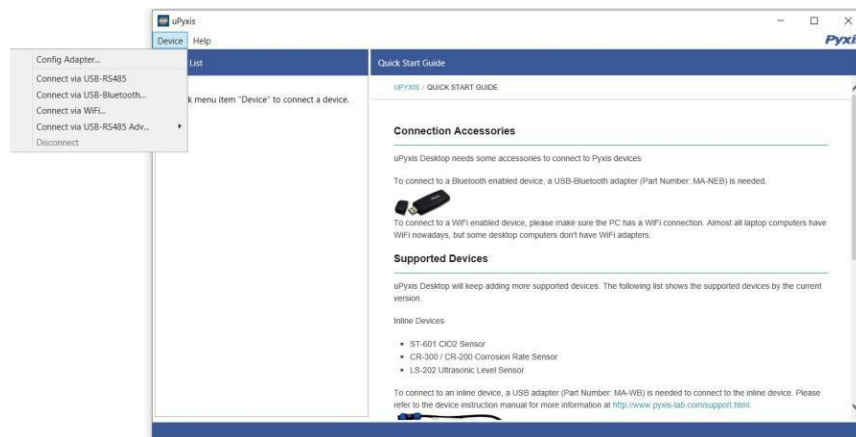

Figure 14.

6.3 Information Screen

Once connected to the device, a picture of the device will appear on the top left corner of the window and the uPyxis® Desktop App will default to the **Information** screen. On the **Information** screen you can set the information description for **Device Name**, **Product Name**, and **Modbus Address**, then click **Set** to save.

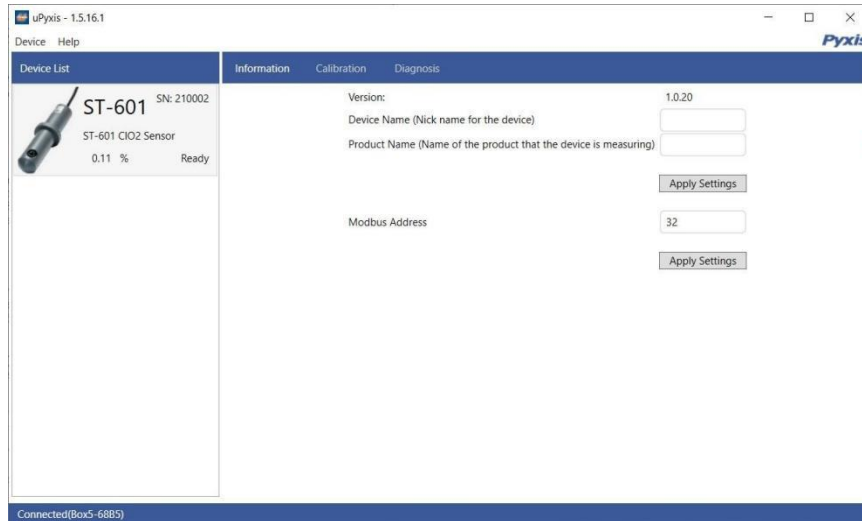

Figure 15.

6.4 Calibration Screen

To calibrate the device, click on **Calibration**. On the **Calibration** screen there are three calibration tabs, **Zero Calibration**, **Slope Calibration**, and **4-20mA Span**. The screen also displays the reading of the device. The reading refresh rate is every 4 seconds.

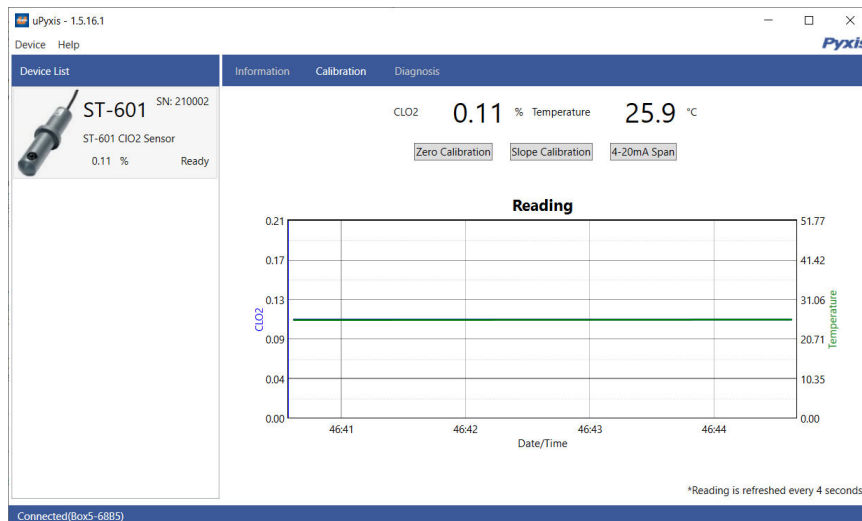

Figure 16.

6.4.1 Zero Calibration

1. Place the ST-601 Series sensor in deionized water.
2. Once the displayed CLO₂ and temperature values are stable, click **Zero Calibration** to perform a zero calibration.
3. If the calibration is successful, the interface will return a message "Calibration Succeeded". If the calibration fails, click **Zero Calibration** again and repeat.

6.4.2 Slope Calibration

1. Place the ST-601 Series sensor in a known CLO₂ calibration standard
2. Enter the CLO₂ concentration in the dialog window as in (figure17). For the best result, the CLO₂ standard concentration should be in the range of 1,000ppm to 3,000ppm for the ST-601 probe.
3. Once the displayed CLO₂ and temperature values are stable, click **Slope Calibration** to carry out the slope calibration. The calibration solution could be the sample CLO₂ itself (in the chemical tank). The concentration of CLO₂ in the sample water can be determined with using a Pyxis SP-910 Handheld meter using CLO₂ High Range Direct Read method (0-1,500ppm), or by conventional titration method.
4. If the calibration is successful, the interface will return a message "Calibration Succeeded". If the calibration fails, click **Slope Calibration** again and repeat.

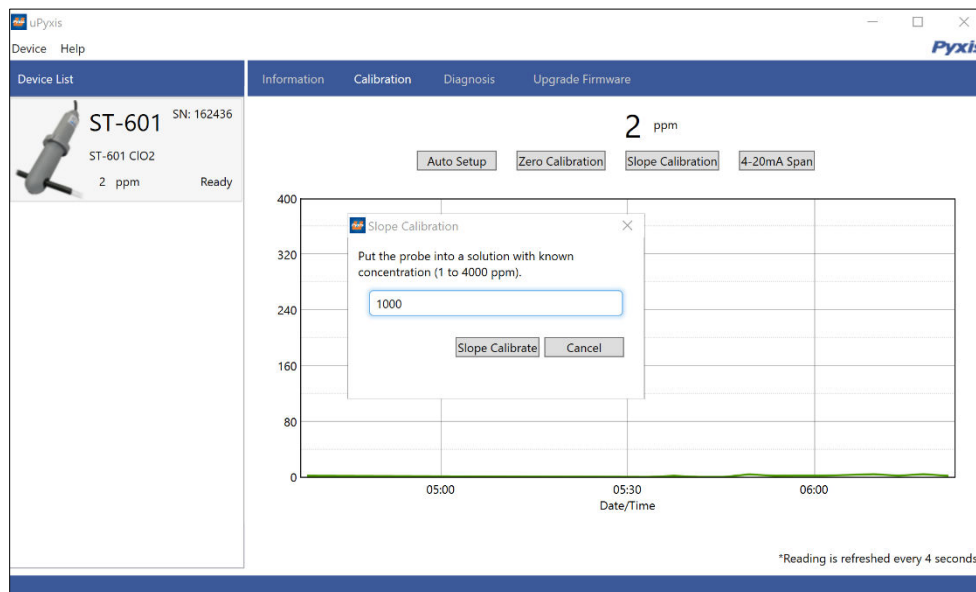

Figure 17

6.5 Diagnosis Screen

To perform a sensor diagnosis and cleanliness check, first insert the sensor into a beaker of DI water or clean tap water and cover the sensor with a towel to protect from ambient light. Select the **Diagnosis Condition** which defines the fluid type that the ST-601 sensor is currently measuring, then click **Cleanliness Check**. If the sensor is clean, a green **Clean** message will be shown. If the sensor is severely fouled, a red **Dirty** message will be shown. In this case, follow the procedure in the **Methods to Cleaning the ST-601 Sensor** section of this manual. From the **Diagnosis** screen, you view and take a screen shot of the diagnosis condition data values. This feature may be used for technical support when communicating with service@pyxis-lab.com.

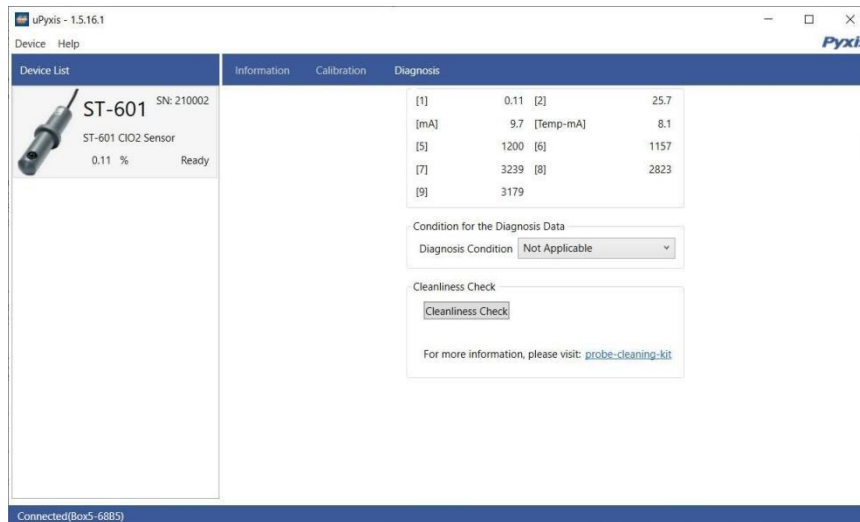

Figure 18.

7 Outputs

7.1 4–20mA Output Setup

The 4–20mA output of the ST-601 sensor is scaled as:

- Chlorine Dioxide concentration:
 - 4 mA = 0%
 - 20 mA = 0.35%
- Temperature:
 - 4 mA = 32 °F (0 °C)
 - 20 mA = 212 °F (100 °C)

7.2 Adjusting 4–20mA Span

Users may adjust the output scale using 4–20mA Span to change the ClO₂ concentration % value corresponding to the 20 mA output via uPyxis®. For the uPyxis® Mobile App, press **4-20mA Span** found on the **Calibration and Reading Screen**, shown in Figure 19. For the uPyxis® Desktop App, click **4-20mA Span** found on the **Calibration Screen**, shown in Figure 20.

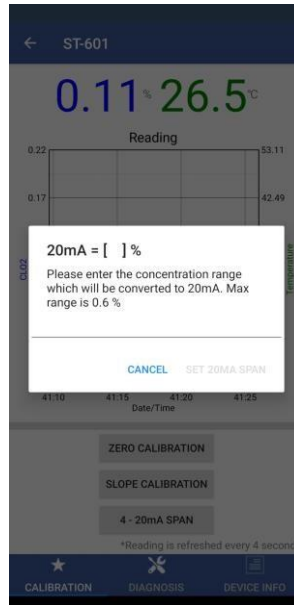

Figure 19.

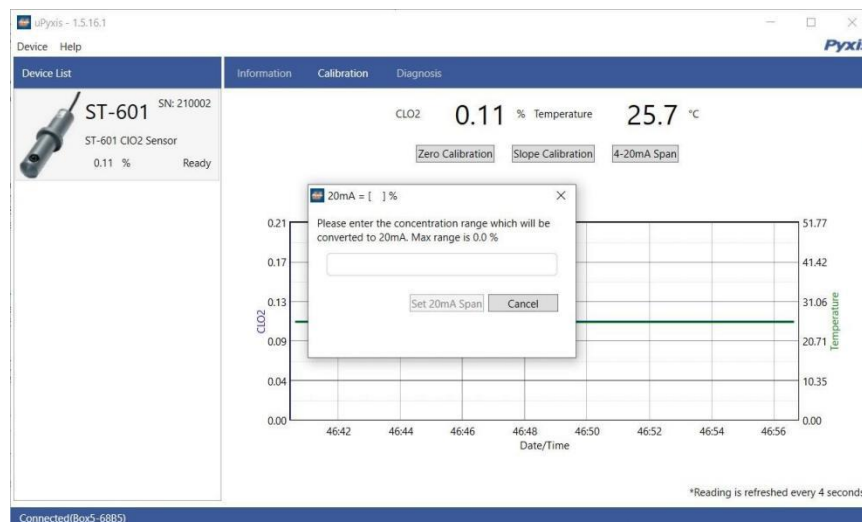

Figure 20.

7.3 Communication using Modbus RTU

The ST-601 sensor is configured as a Modbus slave device. In addition to the ClO₂ concentration % value, many operational parameters, including warning and error messages, are available via a Modbus RTU connection. Contact Pyxis Lab Customer Service (service@pyxis-lab.com) for more information.

8 Sensor Maintenance and Precaution

The ST-601 sensor is designed to provide reliable and continuous bleach readings even when installed in moderately contaminated industrial cooling waters. Although the optics are compensated for the effects of moderate fouling, heavy fouling will prevent the light from reaching the sensor, resulting in low readings and the potential for product overfeed if the ST-601 sensor is used as part of an automated control system. When used to control product dosing, it is suggested that the automation system be configured to provide backup to limit potential product overfeed, for example by limiting pump size or duration, or by alarming if the pumping rate exceeds a desired maximum limit.

The ST-601 sensor is designed to be easily removed, inspected, and cleaned if required. It is suggested that the ST-601 sensor be checked for fouling and cleaned/calibrated on a monthly basis. Heavily contaminated waters may require more frequent cleanings. Cleaner water sources with less contamination may not require cleaning for several months.

8.1 Methods to Cleaning the ST-601

Any equipment in contact with industrial cooling systems is subject to many potential foulants and contaminants. Our inline sensor cleaning solutions below have been shown to remove most common foulants and contaminants. A small, soft bristle brush, Q-Tips cotton swab, or soft cloth may be used to safely clean the sensor housing and the quartz optical sensor channel. These components and more come with a Pyxis Lab **Inline Probe Cleaning Solution Kit** (P/N: SER-01) which can be purchased at our online Estore/Catalog <https://pyxis-lab.com/product/probe-cleaning-kit/>



Figure 21. Inline Probe Cleaning Solution Kit

To clean the ST-601 sensor, soak the lower half of the sensor in 100 mL inline sensor cleaning solution for 10 minutes. Rinse the ST-601 sensor with distilled water and then check for the flashing blue light inside the ST-601 sensor quartz tube. If the surface is not entirely clean, continue to soak the ST-601 sensor for an additional 10 minutes. Use the small, soft bristle brush and Q-Tips cotton swabs as necessary to remove any remaining contaminants in the ST-601 sensor quartz tube.

8.2 Storage

Avoid long term storage at temperature over 100 °F. In an outdoor installation, properly shield the ST-601 sensor from direct sunlight and precipitation.

9 Troubleshooting

If the ST-601 sensor output signal is not stable and fluctuates significantly, make an additional ground connection — connect the clear (shield, earth ground) wire to a conductor that contacts the sample water electrically such as a metal pipe adjacent to the ST-601 tee.

Carry out routine calibration verification against a known ClO₂ concentration solution. After properly cleaning the ST-601 sensor, carry out the zero point calibration with distilled water and slope calibration using the known ClO₂ concentration solution.

10 Contact Us

Pyxis Lab, Inc

21242 Spell Circle

Tomball TX, 77375

www.pyxis-lab.com

Phone: +1 (866) 203-8397

Email: service@pyxis-lab.com

REVISION HISTORY

REV	DATE	DESCRIPTION	PAGE
V2.04	22/01/13	Release	
V2.05	22/09/16	Add calibration details	10,16

REV	DATE	DESCRIPTION	PAGE
V1.0	07/15	Release	
V2.0	05/07	Revision	