

Pyxis[®]

ST-774 Dissolved Oxygen Sensor User Manual



Water Professionals Deserve Better Tools.
www.pyxis-lab.com

Table of Contents

1 Introduction	2
1.1 Main Features.....	2
2 Specifications.....	3
3 Unpacking Instrument.....	4
3.1 Standard Accessories.....	4
3.2 Optional Accessories & Services.....	4
4 Installation	5
4.1 Piping.....	5
4.2 Wiring.....	6
4.3 Connecting via Bluetooth	6
5 Setup and Calibration with uPyxis® Mobile App.....	7
5.1 Download uPyxis® Mobile App.....	7
5.2 Connecting to uPyxis® Mobile App	7
5.3 Calibration Screen and Reading	8
5.4 Diagnosis Screen.....	11
5.5 Device Info Screen.....	11
6 Setup and Calibration with uPyxis® Desktop App	12
6.1 Install uPyxis® Desktop App.....	12
6.2 Connecting to uPyxis® Desktop App.....	12
6.3 Information Screen.....	13
6.4 Calibration Screen	14
7 Outputs	19
7.1 4–20mA Output Setup.....	19
7.2 Adjusting 4–20mA Span	19
7.3 Communication using Modbus RTU	20
8 Sensor Maintenance and Precaution	21
8.1 Methods to Cleaning the ST-774 Sensor	21
8.2 Storage.....	22
9 Troubleshooting	22
10 Contact Us	22

Warranty Information

Confidentiality

The information contained in this manual may be confidential and proprietary and is the property of Pyxis Lab, Inc. Information disclosed herein shall not be used to manufacture, construct, or otherwise reproduce the goods described. Information disclosed herein shall not be disclosed to others or made public in any manner without the express written consent of Pyxis Lab, Inc.

Standard Limited Warranty

Pyxis Lab warrants its products for defects in materials and workmanship. Pyxis Lab will, at its option, repair or replace instrument components that prove to be defective with new or remanufactured components (i.e., equivalent to new). The warranty set forth is exclusive and no other warranty, whether written or oral, is expressed or implied.

Warranty Term

The Pyxis warranty term is thirteen (13) months ex-works. In no event shall the standard limited warranty coverage extend beyond thirteen (13) months from original shipment date.

Warranty Service

Damaged or dysfunctional instruments may be returned to Pyxis for repair or replacement. In some instances, replacement instruments may be available for short duration loan or lease.

Pyxis warrants that any labor services provided shall conform to the reasonable standards of technical competency and performance effective at the time of delivery. All service interventions are to be reviewed and authorized as correct and complete at the completion of the service by a customer representative, or designate. Pyxis warrants these services for 30 days after the authorization and will correct any qualifying deficiency in labor provided that the labor service deficiency is exactly related to the originating event. No other remedy, other than the provision of labor services, may be applicable.

Repair components (parts and materials), but not consumables, provided during a repair, or purchased individually, are warranted for 90 days ex-works for materials and workmanship. In no event will the incorporation of a warranted repair component into an instrument extend the whole instrument's warranty beyond its original term.

Warranty Shipping

A Repair Authorization (RA) Number must be obtained from Pyxis Technical Support before any product can be returned to the factory. Pyxis will pay freight charges to ship replacement or repaired products to the customer. The customer shall pay freight charges for returning products to Pyxis. Any product returned to the factory without an RA number will be returned to the customer. To receive an RMA you can generate a request on our website at <https://pyxis-lab.com/request-tech-support/>.

Pyxis Technical Support

Contact Pyxis Technical Support at +1 (866) 203-8397, service@pyxis-lab.com, or by filling out a request for support at <https://pyxis-lab.com/request-tech-support/>.

1 Introduction

The Pyxis ST-774 sensor is an ultra-low range dissolved oxygen (DO) sensor with a measurement range of 0.0 - 2,000 ppb and lower limit of detection 0.1 ppb ($\mu\text{g/L}$). It is based on the principle of fluorescence quenching to determine the partial pressure of the dissolved oxygen in water. It incorporates Pyxis' advanced technology in the field of fluorescence. The ST-774 offers the robustness associated with optical/luminescent DO sensor technology while achieving the ultra-low detection limit compatible to an amperometric DO sensor.

The ST-774 and other Pyxis dissolved oxygen sensors (ST-772 and ST-776) measure the oxygen partial pressure that is at equilibrium with the dissolved oxygen in water. The relationship between the partial pressure (PO_2) and the concentration of the dissolved oxygen is governed by Henry's law:

$$\text{DO/ppb} = K\text{PO}_2 \quad (1)$$

where K is Henry's Law constant, which is a function of the temperature and the ionic strength (or conductivity) of the water sample. Pyxis uses the latest USGS equations to convert the measured partial pressure and temperature measured by the built-in temperature sensor to a DO value in ppb (or $\mu\text{g/L}$) for the ST-774 sensor.

The ST-774 sensor offers an easily replaceable, front loading DO membrane cap that has been independently developed by Pyxis Lab, with a typical service life of up to two years. The flat front-end design of the ST-774 sensor makes this platform less prone to contamination or fouling and is very easy to clean. The sensor body is composed of 316L stainless steel and is well suited for aggressive industrial application use. The ST-774 sensor offers both 4–20mA and RS-485 Modbus outputs and is Bluetooth enabled when used in conjunction with the MA-CR or PowerPACK Series Bluetooth Adapters.

1.1 Main Features

The ST-774 sensor includes the following features:

- 0.0–2,000 $\mu\text{g/L}$ measurement range
- 0.1 $\mu\text{g/L}$ Lower Level of Detection
- Built-in temperature and pressure sensors
- Accurate and stable measurement with ultra-low drift
- Built-in transmitter without the need of using a preamplifier or meter head
- Dual outputs: isolated 4–20 mA signal and RS-485 Modbus
- Long-distance transmission with higher stability and accuracy
- Wireless calibration, diagnostics, data trend via **uPyxis**® App when used with MA-CR Adapter
- Zero-point calibration with nitrogen and slope calibration in O_2 -containing calibration gas
- Alternative Zero-Calibration using 5% Catalyzed Sodium Sulfite Solution
- ST-774 Service Program (P/N ST-774-SWAP)
 - (a) \$700 Per Year Factory Calibrated/Reconditioned Sensor Only Exchange
 - (b) Client Issues PO#
 - (c) Pyxis sends a new or reconditioned unit
 - (d) Client sends Pyxis the unit in need of recalibration and service
 - (e) Even exchange – eliminates client calibration and maintenance

2 Specifications

Table 1. ST-774 Specifications

Item	Specification
P/N	53715
Output Range for DO (4-20mA)	0.0 - 2,000 µg/L (ppb)
Temp Measuring Range (4-20mA Output Scale) Generation 2 only	32 – 122°F (0 – 50°C) ± 0.2% of value
Lower Level of Detection	0.1 µg/L (ppb)
Dissolved Oxygen Resolution	0.1 µg/L (ppb)
Dissolved Oxygen Accuracy	± 0.3 µg/L (ppb) or ± 1%
Method	Blue Light Irradiated Excitation Red Light Reference
Response Time (90%)	Liquid Phase <30s / Gas Phase <10s
Operational Temperature	0 °C – 50 °C (32 - 122° F)
Operating Voltage	22 – 26V DC, Power 0.6W
Signal Output	4-20mA analog output / RS-485 digital output
Dimension (L x D)	300 x 60mm (11.8 x 2.36 inches)
Weight [†]	1855 g (4.09 lb) cable excluded
Installation Method	¼ inch OD Swagelok
Suggested Flow Range	50 – 500 mL/Minute
Sample Connection Format	Sample Line & Inlet Stainless Steel with Compression Fitting
Material of Construction	316L stainless steel
Working Pressure	Up to 145psi (10Bar)
Material of Construction	316L stainless steel
Cables Length	Attached 1.5 m/4.9 ft 8-Pin cable, MA-1.5CR Cable (1.5 m/4.9 ft 8-Pin Male Adapter/Flying Lead)
Calibration	High Point Calibration: 0.1% Oxygen in Nitrogen Gas Zero Calibration: 5% Catalyzed Sodium Sulfite (12 hour soak) -or- 99.999% Nitrogen Gas
DO Membrane Cap Life	2 years
Enclosure Rating	IP-67/IP-68
Regulation	CE / RoHS

* With Pyxis's continuous improvement policy, these specifications are subject to change without notice. [†] Cables excluded

3 Unpacking Instrument

Remove the instrument and accessories from the shipping container and inspect each item for any damage that may have occurred during shipping. Verify that all accessory items are included. If any item is missing or damaged, please contact Pyxis Lab Customer Service at service@pyxis-lab.com.

3.1 Standard Accessories

The following accessories are included in the ST-774 sensor package (P/N 53715)

- One DCC-2 Dissolved Oxygen Membrane Cap P/N: 53716
- One MA-1.5CR Cable (1.5 m/4.9 ft 8-Pin Male Adapter/Flying Lead) P/N: 50746
- One MA-CR Bluetooth Adapter for 8-Pin Sensors P/N: MA-CR
- One MA-NEB Bluetooth/USB Adapter for use with **uPyxis**® Desktop App P/N: MA-NEB
- Sulfite Zero Calibration Cap P/N 16019
- User Manual available online at [ST-774 Ultra-Low Luminescent Dissolved Oxygen Sensor | Pyxis Lab](https://pyxis-lab.com/ST-774-Ultra-Low-Luminescent-Dissolved-Oxygen-Sensor)® (pyxis-lab.com)

3.2 Optional Accessories & Services

The following optional accessories can be ordered at order@pyxis-lab.com or the Pyxis E-Store at <https://pyxis-lab.com/shop/>

Table 2. Optional Accessories

Accessory Name	P/N
MA-CR Bluetooth Adapter For 8-Pin Pyxis Sensors	MA-CR
ST-774/776 Flow Cell Assembly — Replacement	53718
DCC-2 Dissolved Oxygen Membrane Cap — Replacement	53716
UC-50 Display & Data Logger	43007
Sulfite ZERO Calibration Kit (<i>Includes Calibration Cap and 10mL Sulfite Powder</i>)	16019
Replacement Catalyzed Sodium Sulfite Powder in 10mL vial	SO3-VIAL
MA-50CR Cable (15 m/50 ft 8-Pin Male/Female Extension Cable)	50743
MA-100CR (30.5 m/100 ft 8-Pin Male/Female Extension Cable)	50744
Pyxis Probe Cleaning Kit	SER-01
ST-774 SERVICE-SWAP PROGRAM — ANNUAL*	ST-774-SWAP

NOTE - PO# must be issued for ST-774 Service-Swap Program. Pyxis Ships New/Reconditioned ST-774 Sensor Only. Client Ships Their Sensor to Pyxis for Even Exchange. 30-days to Ship Old Sensor or Pyxis Bills for full value of New ST-774

4 Installation

4.1 Piping

The ST-774 sensor must always be installed in sample flow at or below the upper temperature limit of the sensor (<122 °F). The sample line should always be stainless steel and utilize compression fitting adapters at all junction points to avoid oxygen ingress into the sample water. Using plastic tubing for the sample line and/or threaded-taped junctions will result in oxygen ingress and potential sensor inaccuracy or extended periods of sensor stabilization.

The recommended sample flow rate to the ST-774 is 50 to 500mL/minute. Flows exceeding 500mL/minute may result in unstable oxygen readings. With proper installation using stainless steel sample lines and thoroughly tightened compression fittings, the ST-774 should stabilize to a low level within a few hours after startup. Once this has occurred, you may proceed with the oxygen study/evaluation. If stabilization of the sensor takes a longer period of hours or days, please evaluate your installation for oxygen ingress into the sample line and other on-site application parameters (ie. deaerator operating temperature, pressure, feedwater flow rates, loss of oxygen scavenger feed etc.)

In many applications a sample pre-cooler will be required to adjust sample temperature to an acceptable level. To properly install the ST-774 sensor, follow the steps below:

1. Mount the flow cell of the sensor to a flat surface.
2. Connect the flow cell's 1/4" Swagelok ports are connected to the sample flow line and allow flow cell and ports to fully drain.
3. Make sure that the O-ring is installed properly in the flow cell.
4. Hand-tighten the ST-774 sensor body to the flow cell.

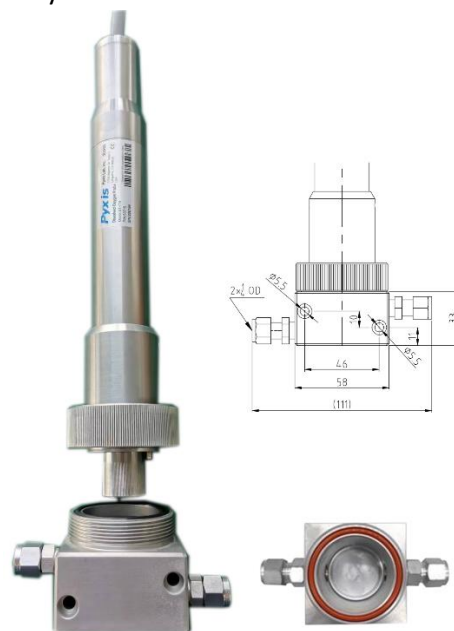

Figure 2. Pipeline installation using ST-774 Flow Cell Assembly (P/N: 53718) with dimensions (mm)

4.2 Wiring

Below are 2 wiring tables. The left represents the first generation of the ST-774 probe with only one 4-20mA output for DO (produced before serial # 210026). The right represents the second generation of ST-774 probe (produced after and including serial # 210026) containing two 4-20mA outputs, one for DO and one for Temperature. Follow the wiring tables below to connect the ST-774 sensor to a controller based on which sensor you have. ***NOTE*** The negative 24V power terminal (power ground) and the negative 4–20mA terminal on the ST-774 sensor are internally connected.

ST-774 First Generation (Prior to Serial # 210026)		ST-774 Second Generation (After and Including Serial # 210026)	
Color	Designation	Color	Designation
Red	24V+	Red	24V+
Brown	24V-	Brown	Power Ground
White	DO 4-20mA +	White	DO 4-20mA +
Grey	4-20mA –	Grey	4-20mA –
Pink	485GNDD	Pink	Temp 4-20mA+
Blue	RS-485 A	Blue	RS-485 A
Yellow	RS-485 B	Yellow	RS-485 B
Green	GNDD	Green	RS-485 C
NA	NA	Black	Shield

Measurement	4mA Value	20mA Value
Dissolved Oxygen	0 µg/L (ppb)	2,000 µg/L (ppb)
Temperature <i>(Generation 2 only See above)</i>	32°F (0°C)	122°F (50°C)

Table 3

4.3 Connecting via Bluetooth

A Bluetooth adapter (P/N: MA-CR) can be used to connect a ST-774 sensor to a smart phone with the **uPyxis®** Mobile App or a computer with a Bluetooth/USB Adapter (P/N: MA-NEB) and the **uPyxis®** Desktop App.

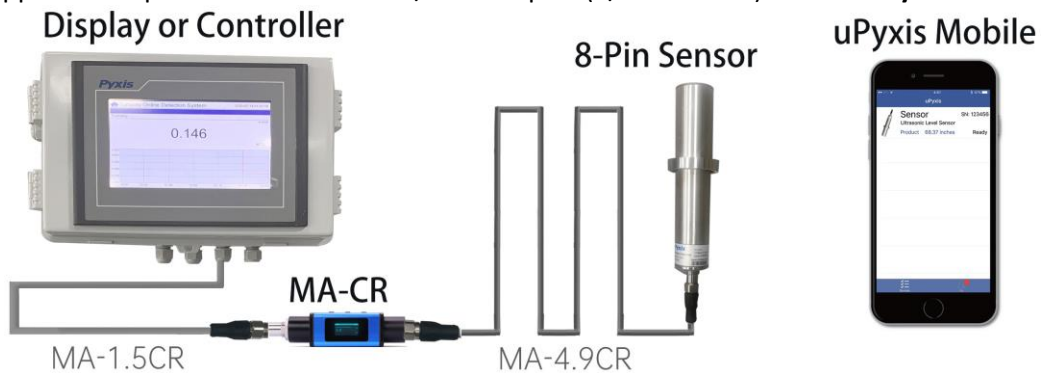

Figure 3. Bluetooth connection to ST-774 sensor MA-CR and uPyxis Mobile App.

5 Setup and Calibration with uPyxis® Mobile App

5.1 Download uPyxis® Mobile App

Download uPyxis® Mobile App from [Apple App Store](#) or [Google Play](#).



Figure 4. uPyxis® Mobile App installation

5.2 Connecting to uPyxis® Mobile App

Connect the ST-774 sensor to a mobile smart phone according to the following steps:

1. Open uPyxis® Mobile App.
2. On uPyxis® Mobile App, pull down to refresh the list of available Pyxis devices.
3. If the connection is successful, the ST-774 and its Serial Number (SN) will be displayed (Figure 5).
4. Press on the [ST-774 sensor image](#).



Figure 5.

5.3 Calibration Screen and Reading

When connected, the uPyxis® Mobile App will default to the **Calibration** screen. From the **Calibration** screen, you can perform calibrations by pressing on **Zero Calibration**, **High Point Calibration**, and **4–20mA Span**.

NOTE Before calibrating, remove the ST-774 sensor from the water and wipe it with a damp cloth to remove debris and any fouling. If there is water on the membrane, dry it with a soft cloth taking care not to damage the membrane.

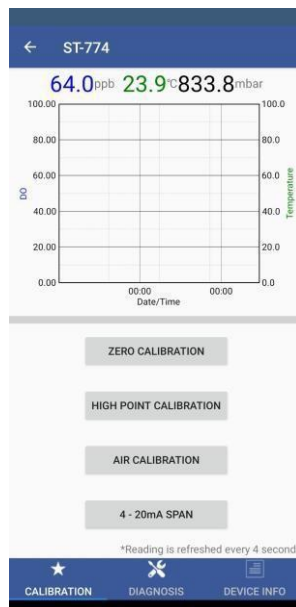

Figure 6.

5.3.1 Zero Calibration Using Sulfite ZERO Calibration Kit (P/N 16019)

- 1) Unscrew the lid from the 10mL vial containing catalyzed sodium sulfite powder (P/N - SO3 VIAL).
- 2) Fill the vial with DI water to the 10mL mark
- 3) Screw the lid on the vial and gently shake for 10 seconds.
- 4) Remove the Sulfite Zero Calibration Cap from packaging.
- 5) Unscrew the lid from the 10mL vial and pour the solution into the calibration cap.



6) Rotate the calibration cap slowly over the front of the sensor. Note: any excess calibration fluid will flow out from the overflow port.

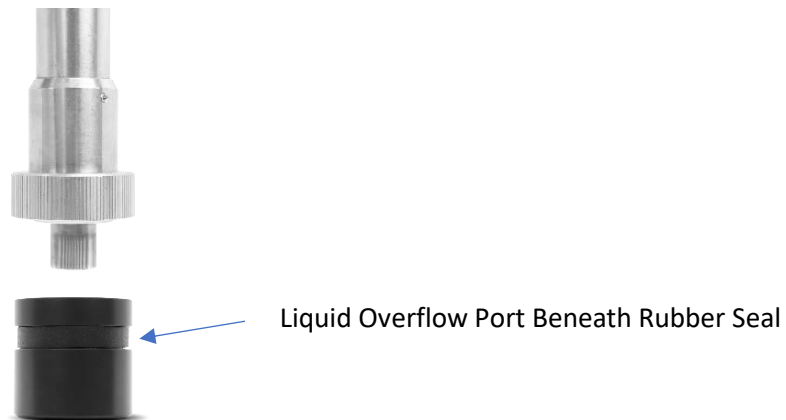

7) Place sensor in upright position with calibration cap at the bottom.



8) Click the **Zero Calibration** button on the app and let stand for 12 hours for best results. ***NOTE***: The uPyxis App can be disconnected during the wait period after the ZERO calibration button has been pressed.

9) After the 12-hour period, remove the calibration cap from the ST-774 sensor and rinse the sensor tip with DI water and insert sensor back into the ST-774 Flow Cell Assembly for service.

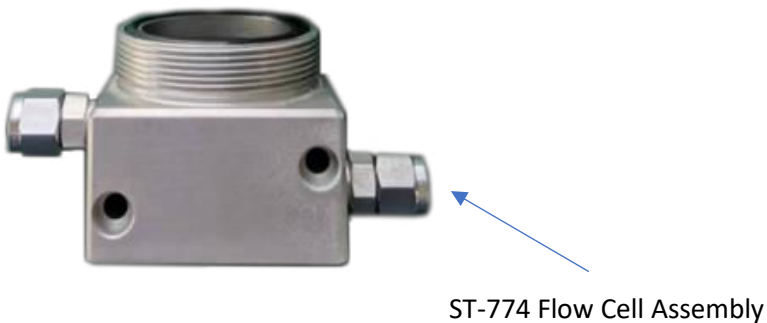

5.3.2 Alternative Zero Calibration Using Pure Nitrogen Calibration Gas (99.999% or better)

A depressurized nitrogen gas source can be connected to the sample cell through the 1/4" OD stainless tubing for the zero-point calibration. The gas flow rate should be regulated between 2 and 10 liter per minute. ***NOTE*** Ensure the stainless-steel compression fittings are very tight and always use stainless steel OD tubing.

- 1) Place the sensor into the ST-774 Flow Cell Assembly.
- 2) Turn on a nitrogen gas flow.
- 3) Allow the gas flow and the temperature to be stabilized for 15 minutes.
- 4) Once the displayed oxygen and temperature values are stable, press **Zero Calibration** to perform a zero calibration.
- 5) If the calibration is successful, the interface will return a message "Calibration Succeeded". If the calibration fails, press **Zero Calibration** again and repeat.

5.3.3 High Point/Slope Calibration Using Nitrogen Gas 99.9% with 0.1% Oxygen Calibration Gas

A depressurized nitrogen with oxygen gas source can be connected to the sample cell through the 1/4" OD stainless tubing for the high-/slope calibration. The gas flow rate should be regulated between 2 and 10 liter per minute. ***NOTE*** Ensure the stainless-steel compression fittings are very tight and always use stainless steel OD tubing.

- 1) Carry out the zero-calibration using nitrogen gas first. See the **Zero Calibration** section.
- 2) Place the sensor into the ST-774 Flow Cell Assembly.
- 3) Turn on a calibration gas (with known oxygen concentration) flow.
- 4) Allow the gas flow and the temperature to be stabilized for 15 minutes.
- 5) Once the displayed oxygen and temperature values are stable, press **High Point Calibration**
- 6) Enter the % Oxygen concentration of the calibration gas to perform a high point (slope) calibration.
- 7) If the calibration is successful, the interface will return a message "Calibration Succeeded". If the calibration fails, press **High Point Calibration** again and repeat.

5.4 Diagnosis Screen

From the **Diagnosis** screen, you can check the diagnosis condition as well as **Export & Upload**. This feature may be used for technical support when communicating with service@pyxis-lab.com

To perform a Cleanliness and Self-Life Check, first select the **Diagnosis Condition** which defines the fluid type that the ST-774 sensor is currently measuring, then press **Cleanliness and Self-life Check**. If the sensor is clean, a **Clean** message will be shown. If the sensor is severely fouled, a **Please replace the DO membrane cap** message will be shown. In this case, follow the procedure in the **Methods to Cleaning the ST-774Sensor** section of this manual.

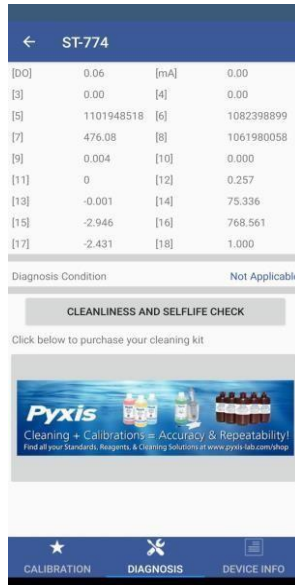

Figure 7.

5.5 Device Info Screen

From the **Device Info** screen. You can name the Device or Product as well as set the Modbus address.

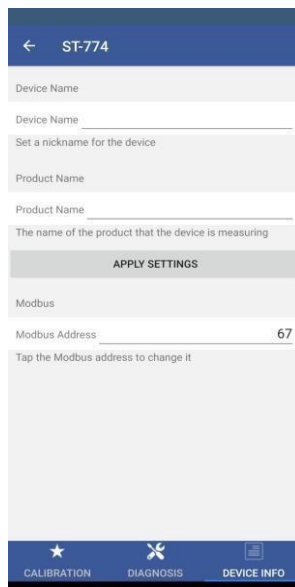

Figure 8.

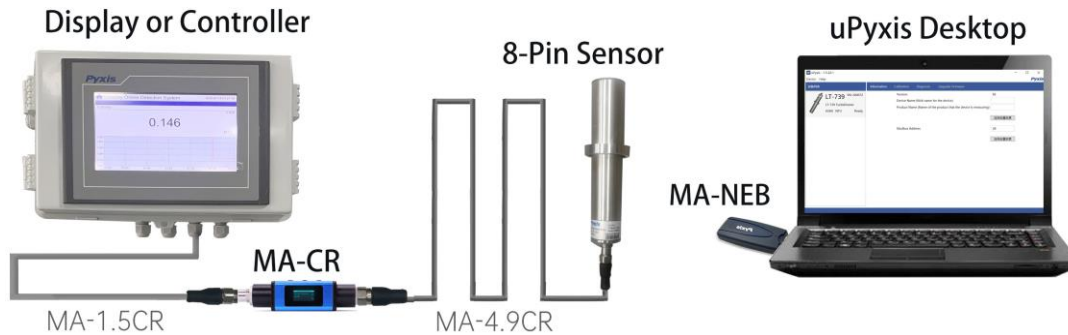

Figure 9. Bluetooth connection to ST-774 sensor MA-CR, MA-NEB and uPyxis Desktop App.

6 Setup and Calibration with uPyxis® Desktop App

6.1 Install uPyxis® Desktop App

Download the latest version of **uPyxis®** Desktop software package from: <https://pyxis-lab.com/upyxis/> this setup package will download and install the Microsoft.Net Framework 4.5 (if not previously installed on the PC), the USB driver for the USB-Bluetooth adapter (MA-NEB), the USB-RS485 adapter (MA-485), and the main **uPyxis®** Desktop application. Double click the **uPyxis.Setup.exe** file to install.

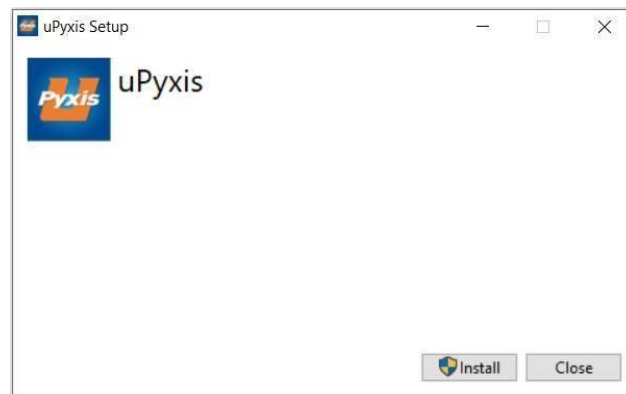

Figure 10. uPyxis® Desktop App installation

Click **Install** to start the installation process. Follow the screen instructions to complete the USB driver and **uPyxis®** installation.

6.2 Connecting to uPyxis® Desktop App

Connect the ST-774 sensor to a Windows computer using a Bluetooth/USB adapter (P/N: MA-NEB) according to the following steps:

1. Plug the Bluetooth/USB adapter into a USB port in the computer.

2. Launch **uPyxis®** Desktop App.
3. On **uPyxis®** Desktop App, click Device → **Connect via USB-Bluetooth** (Figure 10).
4. If the connection is successful, the ST-774 and its Serial Number (SN) will be displayed in the left pane of the **uPyxis®** window. ***NOTE*** After the sensor and Bluetooth is powered up, it may take up to 10 seconds for the adapter to establish the wireless signal for communication.

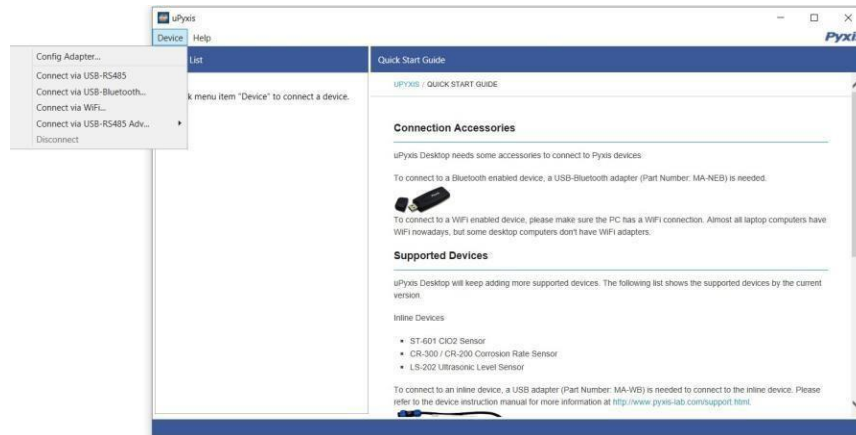

Figure 11.

6.3 Information Screen

Once connected to the device, a picture of the device will appear on the top left corner of the window and the **uPyxis®** Desktop App will default to the **Information** screen. On the **Information** screen you can set the information description for **Device Name**, **Product Name**, and **Modbus Address**, then click **Apply Settings** to save.

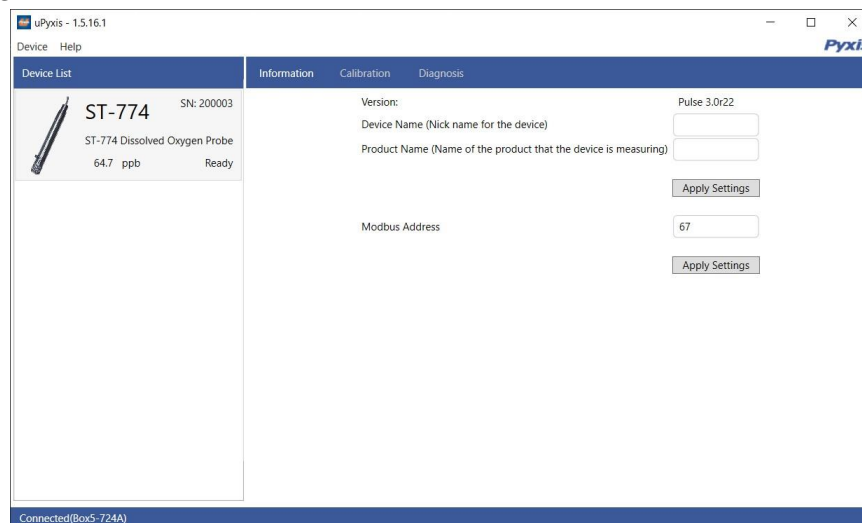

Figure 12.

6.4 Calibration Screen

From the **Calibration** screen, you can perform calibrations by pressing on **Zero Calibration**, **High Point Calibration**, and **4–20mA Span**.

NOTE Before calibrating, remove the ST-774 sensor from the water and wipe it with a damp cloth to remove debris and any biofouling. If there is water on the membrane, dry it with a soft cloth taking care not to damage the membrane.

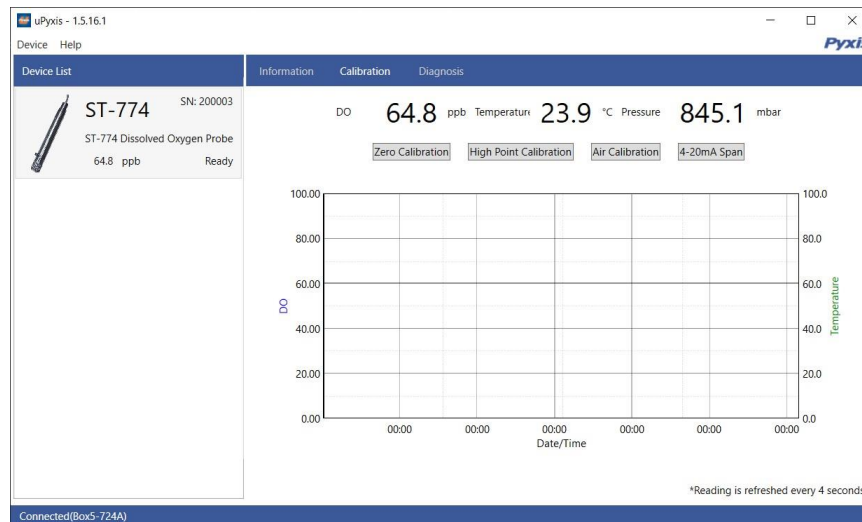

Figure 13.

6.4.1 Zero Calibration

- 1) Unscrew the lid from the 10mL vial containing catalyzed sodium sulfite powder (P/N - SO3 VIAL).
- 2) Fill the vial with DI water to the 10mL mark
- 3) Screw the lid on the vial and gently shake for 10 seconds.
- 4) Remove the Sulfite Zero Calibration Cap from packaging.
- 5) Unscrew the lid from the 10mL vial and pour the solution into the calibration cap.



6) Rotate the calibration cap slowly over the front of the sensor. Note: any excess calibration fluid will flow out from the overflow port.

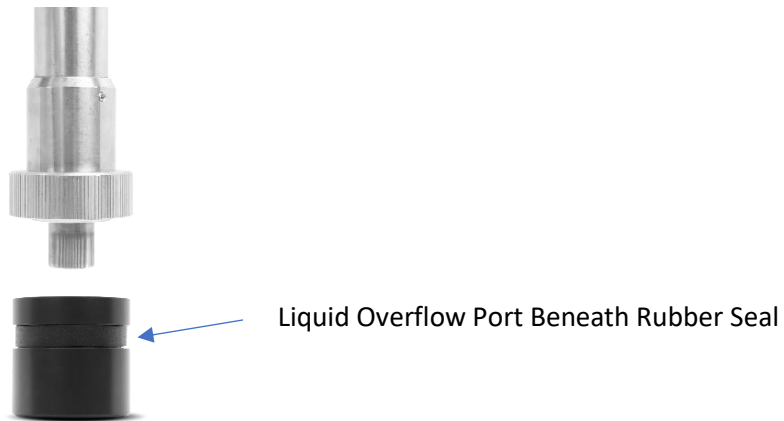

- 7) Place sensor in upright position with calibration cap at the bottom.



- 8) Click the **Zero Calibration** button on the app and let stand for 12 hours for best results. ***NOTE***: The uPyxis App can be disconnected during the wait period after the ZERO calibration button has been pressed.
- 9) After the 12-hour period, remove the calibration cap from the ST-774 sensor and rinse the sensor tip with DI water and insert sensor back into the ST-774 Flow Cell Assembly for service.



ST-774 Flow Cell Assembly

6.4.2 Alternative Zero Calibration Using Pure Nitrogen Calibration Gas (99.999% or better)

A depressurized nitrogen gas source can be connected to the sample cell through the 1/4" OD stainless tubing for the zero-point calibration. The gas flow rate should be regulated between 2 and 10 liter per minute. ***NOTE*** Ensure the stainless-steel compression fittings are very tight and always use stainless steel OD tubing.

- 1) Place the sensor into the ST-774 Flow Cell Assembly.

- 2) Turn on a nitrogen gas flow.
- 3) Allow the gas flow and the temperature to be stabilized for 15 minutes.
- 4) Once the displayed oxygen and temperature values are stable, press **Zero Calibration** to perform a zero calibration.
- 5) If the calibration is successful, the interface will return a message "Calibration Succeeded". If the calibration fails, press **Zero Calibration** again and repeat.

6.4.3 High Point/Slope Calibration Using Nitrogen Gas 99.9% with 0.1% Oxygen Calibration Gas

A depressurized nitrogen with oxygen gas source can be connected to the sample cell through the 1/4" OD stainless tubing for the high-/slope calibration. The gas flow rate should be regulated between 2 and 10 liter per minute. ***NOTE*** Ensure the stainless-steel compression fittings are very tight and always use stainless steel OD tubing.

- 1) Carry out the zero-calibration using nitrogen gas first. See the **Zero Calibration** section.
- 2) Place the sensor into the ST-774 Flow Cell Assembly.
- 3) Turn on a calibration gas (with known oxygen concentration) flow.
- 4) Allow the gas flow and the temperature to be stabilized for 15 minutes.
- 5) Once the displayed oxygen and temperature values are stable, press **High Point Calibration**
- 6) Enter the % Oxygen concentration of the calibration gas to perform a high point (slope) calibration.
- 7) If the calibration is successful, the interface will return a message "Calibration Succeeded". If the calibration fails, press **High Point Calibration** again and repeat.

6.5 Diagnosis Screen

After the device has been calibrated and installation has been completed, to check diagnosis, click on **Diagnosis**. When in the **Diagnosis** screen you can view the Diagnosis Condition of the device. This feature may be used for technical support when communicating with service@pyxis-lab.com. To perform a Cleanliness and Self-Life Check, first select the **Diagnosis Condition** which defines the fluid type that the ST-774 sensor is currently measuring, then click **Cleanliness and Self-life Check**. If the sensor is clean, a **Clean** message will be shown. If the sensor is fouled, a **Please replace the DO membrane cap** message will be shown. In this case, follow the procedure in the **Methods to Cleaning the ST-774** section of this manual.

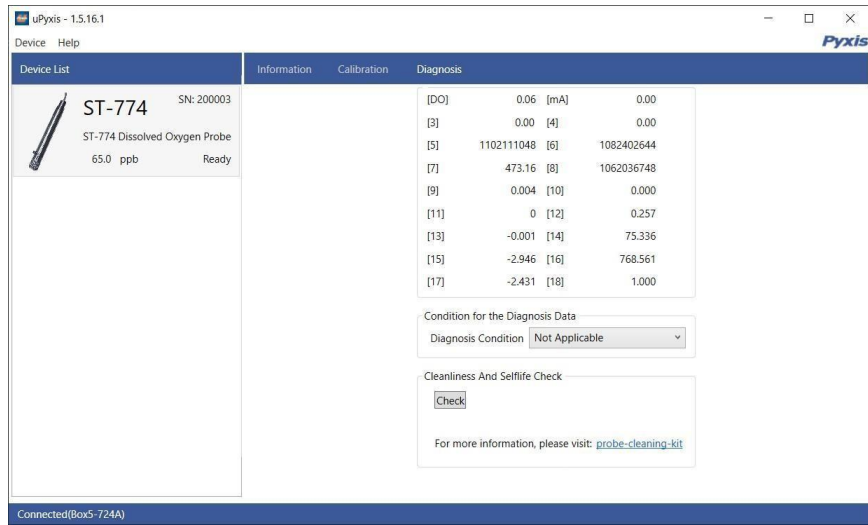

Figure 14.

7 Outputs

7.1 4–20mA Output Setup

The 4–20mA output of the ST-774 sensor is scaled as:

- Dissolved Oxygen:
 - 4 mA = 0 ppb
 - 20 mA = 2000 ppb

7.2 Adjusting 4–20mA Span

Users may adjust the output scale using 4–20mA Span to change the dissolved oxygen ppb value corresponding to the 20 mA output via **uPyxis**[®]. For the **uPyxis**[®] Mobile App, press **4-20mA Span** found on the **Calibration and Reading Screen**, shown in Figure 15. For the **uPyxis**[®] Desktop App, click **4-20mA Span** found on the **Calibration Screen**, shown in Figure 16.

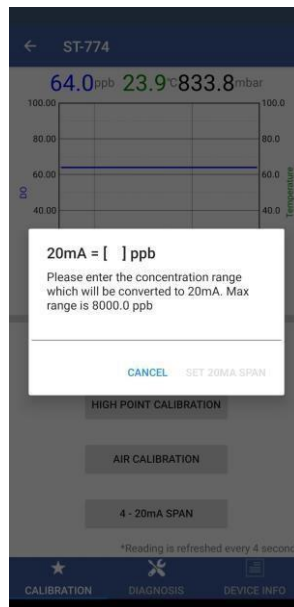

Figure 15.

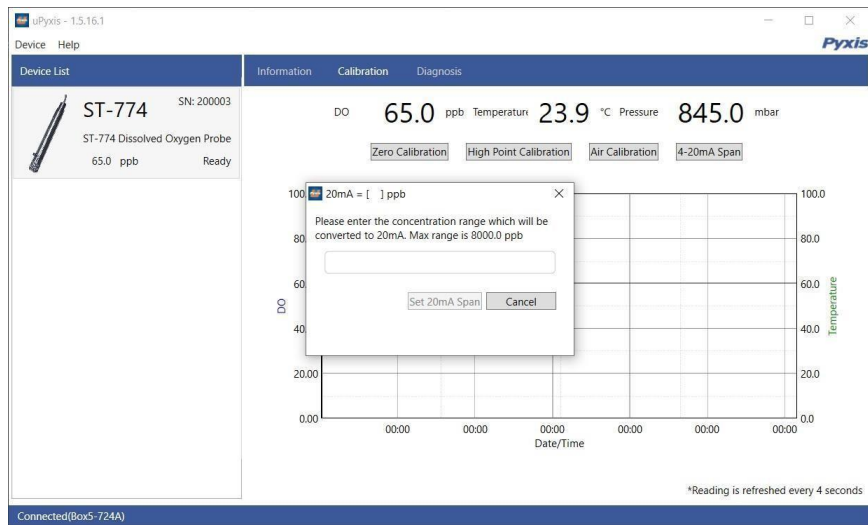

Figure 16.

7.3 Communication using Modbus RTU

The ST-774 sensor is configured as a Modbus slave device. In addition to the dissolved oxygen ppb value, many operational parameters, including warning and error messages, are available via a Modbus RTU connection. Contact Pyxis Lab Customer Service (service@pyxis-lab.com) for more information.

8 Sensor Maintenance and Precaution

The ST-774 sensor is designed to provide reliable and continuous dissolved oxygen readings even when installed in moderately contaminated industrial waters. Although the optics are compensated for the effects of moderate fouling, heavy fouling will prevent the light from reaching the sensor, resulting in low readings and the potential for product overfeed if the ST-774 sensor is used as part of an automated control system. When used to control product dosing, it is suggested that the automation system be configured to provide backup to limit potential product overfeed, for example by limiting pump size or duration, or by alarming if the pumping rate exceeds a desired maximum limit.

The ST-774 sensor is designed to be easily removed, inspected, and cleaned if required. It is suggested that the ST-774 sensor be checked for fouling and cleaned/calibrated on a monthly basis. Heavily contaminated waters may require more frequent cleanings. Cleaner water sources with less contamination may not require cleaning for several months. The need to clean the ST-774 sensor can be determined by the **Cleanliness and Self-life Check** using either the **uPyxis®** Mobile App (see the **Mobile Diagnosis Screen** section) or the **uPyxis®** Desktop App (see the **Desktop Diagnosis Screen** section). If the **Cleanliness and Self-life Check** continues to return a **Please replace the DO membrane cap**, use an Allen wrench to remove the protective cover, unscrew the current membrane cap, check whether the inside of the ST-774 sensor flashes blue and red light, then screw on a new membrane cap and re-fasten the protective cover.

8.1 Methods to Cleaning the ST-774 Sensor

Any equipment in contact with industrial cooling systems is subject to many potential foulants and contaminants. Our inline sensor cleaning solutions below have been shown to remove most common foulants and contaminants. The surface of the DCC-2 Dissolved Oxygen Membrane Cap can be cleaned with a cotton swab. Please do not use sharp instruments to clean the membrane cap. In addition, the Pyxis Inline Probe Cleaning Solution Kit may also be used to removal of heavy deposits, especially inorganics, and can be purchased at our online E-Store <https://pyxis-lab.com/product/probe-cleaning-kit/>.



Figure 17. Inline Probe Cleaning Solution Kit

To clean the ST-774 sensor, remove the sensor and the DO membrane cap from the water in use, wipe it with a damp cloth to remove debris and growing organisms, and use a cotton swab dipped in water to clean up the dirt on the membrane surface. Unscrew the membrane cap, check whether the inside of the ST-774 sensor flashes blue and red light; after the inspection, screw the DO membrane cap back onto the sensor.

8.2 Storage

Avoid long term storage at temperature over 100 °F. Avoid long term storage with the sensor exposed to ambient light as it may reduce the membrane lifetime. In an outdoor installation, properly shield the ST-774 sensor from direct sunlight and precipitation.

9 Troubleshooting

If the ST-774 sensor output signal is not stable and fluctuates significantly, make an additional ground connection — connect the black (shield, earth ground) wire to a conductor that contacts the sample water electrically such as a metal pipe adjacent to the ST-774 tee.

10 Contact Us

Pyxis Lab, Inc

1729 Majestic Dr. Suite 5
Lafayette, CO 80026 USA

www.pyxis-lab.com

Phone: +1 (866) 203-8397

Email: service@pyxis-lab.com